



A BEAUTIFUL ACHING

INSIGHTS AND PERSPECTIVES

DRAZEN ROB

abeautifulaching.com

RELEASE

2024.04.14



T TABLE OF CONTENTS

About.....	7
Writing Style	9
Introduction	13
What's In A Name?.....	15
Unrequited Love.....	17
The Conflict.....	21
The Destructive Solution Explored.....	23
The Creative Solution Explored	25
The Fundamental Process Of Nature.....	29
This Is Heady Stuff.....	33
What's Love Got To Do With It?	35
The Overview	37
Grace	39
Strength	41
Wisdom.....	43
Teaching vs Indoctrinating.....	47
Creation Is A Nincompoop.....	51
Dualistic Counterparts	55
The Electric Circuit Analogy	59
The Dark Cupboard	61
The Spring Scale Analogy	63
The Thug, The Coward.....	65
Understanding Space/Time	67
The Universe Is How Old?	71
The Transcendence Of Truth.....	75

A BEAUTIFUL ACHING

Hope And Belief	79
Nature, The Algorithm.....	81
Real Change.....	85
The Meaning Of Context.....	87
The Infinity Coin.....	91
The Structure Of Integrity.....	93
The Infinity Of Singularity.....	95
Avoid Stress And Anxiety?.....	99
The Dangling Carrot.....	101
Anatomy Of The Human Being.....	107
The Human Psycho-Biological Organism.....	111
The Physical Body.....	115
The Emotional Body.....	117
The Psychological Body.....	121
Characteristics Of The Three Bodies.....	125
Calibrating For Truth.....	131
Foundation Of Duality.....	135
Crash The Algorithm, Part One.....	139
Crash The Algorithm, Part Two.....	145
Division By (0), A Conceptual Exercise.....	151
A Discussion About Models.....	155
The Direction Of Resolving Conflict.....	157
The Human Consciousness Model.....	161
Perspectives On Truth.....	169
Spectrum Of Awareness.....	171
Manipulate The Algorithm?.....	175
The Anti-Authoritarian Party.....	177
The Heart Centre.....	187
Mind/Spirit.....	189

Soul Consciousness.....	195
Universal/Creation Consciousness.....	199
Singularity.....	203
What Now?	205
Appendix A – Supportive Verses.....	207
Beware, The Expert	209
The No Risk Fallacy.....	213
The Myth Of Randomness	217
Science And The Universe.....	221
The Illusion Of Growth.....	225
Room To Be Afraid, Room To Fail	233
The Authoritarian State.....	235
Objective Truth	241
Reflection Of Perfection.....	243
Perception Of Imperfection.....	249
Stillness Of The Spinning Disc.....	251
Representing The Circle	255
Polygonal Convergence	263
Polygon Spirals	271
The Insidiousness Of Worship.....	275
Cages And Murals	279
The Tree.....	281
The Unrelenting Teacher	285
The Game Of Life.....	291
Malicious Intelligence	293
Free Will?	297
The Social Degradation Spiral	299
The Individual’s Stand.....	303
War Heroes.....	305

A BEAUTIFUL ACHING

Ideology And Religion	313
Morality Intertwining Integrity	331
The Shadow Self	335
Opportunity Costs Of Creation	339
The Power Of Creation	343
Fish Of The Ocean.....	349
Virtuosities!	353
Confusing Verbs With Nouns	357
Defining Spirituality	359
The Disassociation Of Sovereignty	363
Tyranny Cheers	369
Human Nature? Whose Human Nature?	375
Perceptions And Realities	379
God Is Dead!	389
Knowing Infinity	393
Clock Frequencies Of The Sun	399
Getting One's Attention	401
Offended Yet?	403
Humanity's Purpose.....	411
Health Care ≠ Medical Aid.....	419
Writing For Meaning.....	423
Master The Mundane.....	427
Commanding Hypocrisy	431
Normalising The Abnormal.....	439
Misguided Super Heroes	443
Directions To Find God	449
Preserving Culture?.....	459
Subservient To Illusion.....	465
This Is Serious.....	479

Never-Ending God Nonsense 483

Pontificating Poppycock 491

The Myth Of Equality 495

Traversing The Darkness 499

Negative Value?..... 507

Awareness Stability Range 511

Nonsensical Numerology 513

Fake Identity, Superficial Identity 517

Crowded Consciousness 523

Rules Of The Game 535

Worshipping Insanity 539

Orwellian Re-Branding 545

The Political Soul? 551

A Soul’s Catch 22 557

Extrasensory Perception 559

What’s Going On? 561

The Socialist Problem 569

Turn It Up!..... 575

Reason For Being 587

Fictions Of A Higher Power 597

Motley Musings..... 605

A Retrospect 621

Reflections Of Beginnings And Endings..... 635

Creation Of The Fire Blossom..... 645

The Gift..... 661

Dedication..... 665

Appendix B – Whispers From The Forgotten Series..... 667

Whispers From The Forgotten..... 669

First K’Duhn..... 675

A BEAUTIFUL ACHING

A Pure Heart.....	677
Second K'Duhn.....	685
Poison For The Wicked.....	687
Third K'Duhn.....	693
The Final Call.....	695
Fourth K'Duhn.....	707
The Insertion.....	709
Fifth K'Duhn.....	717
Sixth K'Duhn.....	719
Foundations Of The Formless.....	721
Appendix C – Hollowing The Sphere Calculations.....	725
Appendix D – Exygen.....	741
Appendix E – Gandalf And Frodo’s Exchange In Khazad-dûm.....	753
Appendix F – Falling In Reverse.....	755
Appendix G – The Middle East Solution, Live!.....	769
Appendix H – The United States Constitution.....	773
Appendix I – Riding On Coattails.....	775

A ABOUT

A Beautiful Aching is the expression of one person's experiences and the resultant outcomes in Understanding from those experiences. It is a personal passion project.

This document is not about motivational statements to make One simply, *"Feel Good"*. It is about discussing fundamental issues of the Human condition on a foundational level.

Is it not better to know where One currently stands, rather than be told all is fine, no matter the urgency of a situation?

When it comes down to it, this text is a Self-exploration, Self-discovery tool.

"Who are you?", "What are you?", "What is this place?", "Why are you here?" and of course *"How do you relate to yourself?"*

One needs to begin to explore, to have any hope of finding these answers.



*If One does not Understand
the True context from which they exist,
then One has no possibility
of Knowing that which they Truly are.*

A Beautiful Aching

WRITING STYLE

*Do Not Interpret
what is being said.*

*Understand
what is being said.*

The style in which these writings are presented may seem quite venerating, but when broaching the subjects that are explored, it is almost impossible not to express them with reverence and respect. When One is discussing the process of Creation, how can that not be the case? Look at what is being Created.

The framework which underpins this work is as follows,

- This publication is broken up into sections and those sections will be referred to as “*Verses*”. The reason for this is that they are too short to be considered chapters and they can also be read out of order or in isolation. Although it is best to view them in the context of one another.
- The writing is intended to be light, airy, with roughly one to three sentences per paragraph. This makes the information easier to ingest and understand, as opposed to long, dense paragraphs.
- Everything is to be written in Present Tense. Contextual setups and Quotations are exempt.
- Generally, verses are setup like a bread crumb trail. Either the verse asks a question at the beginning, then drops logical crumbs to the conclusion, or it makes a statement at the beginning then offers a logical trail to validate that statement.

A BEAUTIFUL ACHING

- Verses themselves are also stepping stones, with previous verses providing context for newer verses. Although, once the original Overview verses have been read, it is possible to jump to any subsequent verse and find value in it.
- There is a mindful attempt to present the information as an objective description rather than a subjective opinion.
 - An objective description is, *“The experience was pleasurable (or painful)”*. There is no value judgement in this case, just a statement about the experience.
 - A subjective opinion is, *“I prefer pleasure (or pain)”*. A subjective opinion is a preference or a value judgement. There is nothing wrong with this, One should simply be aware of what it is.
 - The terms *“Good”* and *“Bad”* are also value judgements that are avoided, unless they are used in the context of a quotation.
- A capital letter at the start of certain nouns and verbs is used to refer to the Universal aspect of what these words mean and to also highlight particular words. For example,
 - Using the word Creation with a capital *“C”* refers to the Universal Creation. A lower case *“c”* could refer to something a Human may create.
 - Using capital letters like *“I”* and *“O”* in the words Inner and Outer is to emphasise these Dualistic counterparts.
- The writing is presented in a Third Person Perspective. The use of the words *“I”* or *“You”* is avoided unless they are used in the context of a quotation.
 - Any reference to the Individual is made as *“One”* or *“the One”*.
 - Any reference to an Individual other than the One is made as *“Another”* or *“the Other”*.

- They/Them pronouns are used extensively throughout this blog in reference to the non-specific singular Individual. The reason being, is that when referring to a non-specific Individual, that Individual can either be Male or Female.

To encompass both genders with pronouns would require using the combined terms He/She or Him/Her incessantly, which would make for an awkward reading experience. So to improve readability, They/Them pronouns are utilised instead.

When referencing a specific Individual, He/She or Him/Her pronouns will be applied where applicable.

- Verses are presented in a form that is accessible by the average person. Any technical jargon is kept to a basic level and contorted leaps of logic are avoided.
- Verses are intended to be light on words but dense on substance, so One can come back in one week or one year and potentially gain a different insight and viewpoint of the topic being addressed.
- Red, underlined words and phrases are the titles of the verses that they are referencing.

INTRODUCTION



*A Beautiful Aching is offered
as an Oasis in the Desert.*

*It is up to You,
to come and Drink.*

As is mostly the case, it is best to begin at the beginning and in this instance that would be the first verse, [What's In A Name?](#).

However, to appreciate and best understand what is being presented, please read the [About](#) and [Writing Style](#) sections first before moving on to the verses.

Following that, it is advised to read the Overview verses prior to any subsequent verses, as this establishes a context for the exploration that is to unfold.

The Overview verses, in their intended reading order, are as follows:

A BEAUTIFUL ACHING

1. [What's In A Name?](#)
2. [Unrequited Love](#)
3. [The Conflict](#)
4. [The Destructive Solution Explored](#)
5. [The Creative Solution Explored](#)
6. [The Fundamental Process Of Nature](#)
7. [This Is Heady Stuff](#)
8. [What's Love Got To Do With It?](#)
9. [The Overview](#)

*I am not here for
Cowards or Revolutionaries.*

*I am here for
The Courageous Rebel.*

WHAT'S IN A NAME?

The primary catalyst for all that is to be presented throughout this volume, can be encapsulated in the following dialogue.

Q. Do you love her?

A. ?...No!

Q. What do you mean?

A. Love couldn't handle the intensity,
so it got left in the dust a long way back.

Q. So what do you call it?
How do you describe it?

A. I don't call it anything.
How do I describe it...?

A Beautiful Aching.

Birth is a painful process with an extraordinary outcome.

Similarly, Creation is a Painful process with an Extraordinary outcome.

Welcome.

Let's Explore.

A BEAUTIFUL ACHING



A BEAUTIFUL ACHING

UNREQUITED LOVE

Let me guess, there's a girl?

Of course there's a girl.

There's always a girl.

In an Unrequited Love scenario there is a situation where One feels strongly and passionately for Another, but the Other does not reciprocate those feelings.

Naturally, this will expose a Conflict within Oneself.

Hence, the underlying question will arise,

*“How can One feel so strongly and intensely for the Other,
but the Other feels nothing in return?”*

One is within their right to feel as they feel for the Other. But also, the Other is within their right to feel or not to feel.

In fact, neither can help what they feel or do not feel.

Now, the turmoil begins.

How to resolve this conundrum?

The passion is intense, the longing to be with the Other is extreme. But still, it goes unfulfilled.

A BEAUTIFUL ACHING

Angst, Torment, Pain; Excruciating, Unbearable.

The Questions.

How?

What?

Why?

“LEAVE! ME! ALONE!”

Then..., The Answer.

What is this..., Answer?

The Answer is..., The Flower.

What?!!

The flower will emit its fragrance even though none may be present to partake of its scent. There is no angst in the flower because no one is near to smell its aroma, it will express its perfume nonetheless.

As for the One that feels passion and affection toward the Other, they accept what they feel regardless of how the Other feels.

They honour themselves by allowing their feelings for the Other and in doing so, they honour the Other.

The outcome?

Peace.

Can it not be seen, that all Conflict is essentially, Unrequited Love?



A BEAUTIFUL ACHING

THE CONFLICT

*Conflict is the
Catalyst
for Contemplation.*

Conflicts are nothing more than problems without a solution, equations that have yet to be solved, questions that have gone unanswered. Answering or solving these leads to Understanding, which then transitions to Knowing.

When One experiences a Conflict, there is a strong Energy component to it. Energy Flow is what drives the Universe, so Energy drives Conflict.

Intensity is generated when there is resistance and by its very nature, Conflict exposes resistance.

All Conflicts will have an Inner and Outer component to them, this is the Dualistic nature of the situation, with the Outer being merely a reflection of the Inner. Avoiding the Inner Conflict will never fully resolve the Outer, because if the focus is on dealing with the Outer Conflict alone, then One is just forever chasing shadows.

Ongoing, unresolved Inner Conflict can be a precursor to a greater Outer Conflict. Which may then lead to violence and destruction should the Inner Conflict persist unresolved.

Nature cannot allow a Conflict to go unresolved indefinitely. It cannot allow an impasse, it cannot let Energy stagnate. Doing so ultimately leads to Death and Nature cannot Die. If Nature Dies, All Life Dies.

Should there be a Conflict that has gone unresolved for an extended period of time, Nature will direct more Energy into it, which will increase the Intensity being experienced, thus forcing a resolution to the Conflict.

A BEAUTIFUL ACHING

Nature has no preference when it comes to how a Conflict is resolved, the resolution can be Creative or it can be Destructive. The choice is up to those experiencing the Conflict.

*The role of the Antagonist is to expose
One's deficiencies and insecurities.*

*Because only when they've been exposed,
can they be resolved.*

Primarily, fear of Conflict equates to a fear of looking deeper for Understanding of Oneself.



A BEAUTIFUL ACHING

T THE DESTRUCTIVE SOLUTION EXPLORED

When One is faced with an Inner Conflict that they are unprepared to resolve, they will try to find ways to either,

1. Avoid and ignore the Conflict.
2. Dissipate the Energy driving the Conflict.

By doing so, they may reduce the Intensity temporarily and thus gain a period of reprieve.

AVOIDING THE CONFLICT

Distraction or attempting to move One's Awareness away from the Conflict is the primary method for avoiding and ignoring the Inner Conflict. This can be achieved by obsessing over other activities, unnecessary busy work, seeking constant sensual stimulation (stimulation of the senses) and substance abuse. This technique only really works while the Intensity is relatively low.

The way a high Intensity Conflict is avoided and ignored is to push it out of One's Awareness altogether, which leads to the creation of the "*sub-conscious*". This then compartmentalises the Conflict and allows time for a resolution. But in so doing, creates a backlog which one day must be addressed and accounted for.

DISSIPATING ENERGY

A method that is used to dissipate Energy, thus temporarily reduce Intensity, is Self-destructive behaviour such as heavy, repetitive substance abuse. This forces the available Energy to be consumed in repair and healing of the body.

A BEAUTIFUL ACHING

The physical body is the primary vessel for experience and interaction in this material reality, hence without it, all else is irrelevant. That is why it must be maintained to a minimal level of health for any material experience to be possible and the reason why Energetic priority is given to its well-being first and foremost.

So, in effect, by constantly engaging in activities which damage the physiological body, Energy must be consumed in repair on the physical level. Therefore, there is little Energy left to initiate deeper levels of healing of the Human Being, consequently the deeper Conflicts are never addressed.

If a point is reached where One can no longer avoid the Intensity of the Inner Conflict and is unwilling to face it, then what comes about is a situation of “*Path of Least Resistance*”. The Inner Conflict seems insurmountable, so the only other solution is to inflame the Outer component of the Conflict, which may potentially lead to violence. This also dissipates the Energy temporarily, but can bring on feelings of guilt and Self-loathing, which in turn could feed the Inner Conflict even further.

These additional feelings of guilt and Self-loathing may also be repressed, adding to the backlog of Conflicts that require resolution.

There is usually a combination of both strategies at play when manoeuvring to avoid the Inner Conflict, with the outcome of such choices being a spiral of Self-destruction.



A BEAUTIFUL ACHING

T THE CREATIVE SOLUTION EXPLORED

*Bring Awareness to the Inner Conflict...,
Face and Allow the Intensity...,
A Resolution Will Come.*

This approach is not a quick fix, real solutions that have a strong foundation take time. One can buy into superficial facades, but all facades eventually crumble, no matter how thick their construction.

This approach is about stripping back the facade, chipping away at its thick, hard, crusty shell, exposing more and more of what lay beneath. It is not an additive process where something must be done. It is a subtractive process where something must be let go.

It may seem a little ironic that a process titled the “*Creative Solution*” is actually deconstructive in nature. This is because it is Inwardly Deconstructive, Outwardly Constructive.

*A journey of a thousand miles,
begins with the first step.*

The often quoted saying above is apt, because it is the only solution available to gain real, substantial results. There are no quick fixes, there are no shortcuts, there are no ways to fake a real resolution.

A BEAUTIFUL ACHING

Any attempt to bring down the facade all at once is also not possible, nor advised. The Energy and Intensity involved would easily crush the unprepared and reset the Conflicts all over again.

The solutions that present themselves with this method may not necessarily be the solutions that are desired, but they are the solutions that are needed. Attachment to specific outcomes is its own Conflict that must be confronted, if One is to move beyond this condition.

Additionally, the solutions may not be a direct course of action to take, they instead may offer a deeper Understanding of the Conflict in question or they may simply allow for the acceptance of a certain, difficult situation.

At any stage in the Creative Solution approach, One will experience the Intensity that One can handle. But then, One can handle a lot more than One thinks.

To lighten the load that may be felt while reading this verse, be assured that there are relief stops along the way, places that allow for moments of calm, places to breathe, without facing constant, Intense Conflict all the time.

As One experiences the breakthroughs with each Creative resolution, there will be a sense of a burden being shed and a real satisfaction from the Understanding that follows.

*

BRING AWARENESS TO THE INNER CONFLICT...

FACE AND ALLOW THE INTENSITY...

A RESOLUTION WILL COME.



A BEAUTIFUL ACHING

THE FUNDAMENTAL PROCESS OF NATURE

*Creation is the primordial Question,
Eternally searching for its Answer.*

Singularity cannot Know what it is, until it has something to reflect off of.

Just like One cannot know what One looks like, until they stand before a mirror to see their own reflection.

By asking the very first Question, Singularity is effectively creating a mirror.

A mirror is a Question. A Question is a mirror.

Creation is the resonant reflection of Singularity/Source/Consciousness looking at itself.

Poking, Prodding, Challenging, Exploring.

The Question,

“What is this that I AM?”

When One looks into a mirror, is not a similar question being asked? Does One not ask,

“How do I look?”

Duality is the framework for the Questions to be asked.

The Conflicts are the Questions.

A BEAUTIFUL ACHING

The outcomes to those Conflicts are the Solutions.

If the Solutions work, then Creation is birthed.

If the Solutions do not work, Destruction is the result.

Knowing what does not work is just as valuable as Knowing what does, if not more so.

In a sense, more is gained by exploring the possibilities that do not work because then there is a better Understanding for those Solutions that do work and why they work.

But a Destruction is also not the end, it is simply that the Conflict has been reset or a new, greater Solution has been found.

So, the perpetual cycle: Conflict – Solution – Understanding – Knowing – Conflict – Solution – Understanding – Knowing...

There are no wasted efforts. There are no true failures. All is valid, because all contributes to Knowing.

Singularity cannot change what it IS.

Singularity can only venture to Know what it IS.

CLARIFICATION

Clarification for the above statement,

“All is valid, because all contributes to Knowing.”

Validity in this context can be expressed in the following scenario.

If a building collapses due to poor design, poor construction, ignorance or incompetence, then the collapse is a valid outcome for the situation and events leading up to the failure. It demonstrates that those responsible for the construction lack the Understanding or willingness to design and construct such a building.

Therefore, the situation provides the opportunity to investigate and gain the Understanding required to create a building that will possess the resilience and integrity to stand resolute.

An outcome maybe Unpleasant, but Pleasantness and Unpleasantness are not determining factors for validity.

The point of this, on a Human level, is to attain a state where One is approaching and observing Conflicts from the direct perspective of the Source itself. Rather than from the perspective of One whose Awareness is lost and stuck in a deep, dark labyrinth of Conflicts.

This is achieved through the Ultimate resolution of Inner Conflict.

*One is always free
to Know and Understand.*

*But One should not be forced
to Know and Understand.*

*Nor is One entitled
to Know and Understand.*

*

BRING AWARENESS TO THE INNER CONFLICT...

FACE AND ALLOW THE INTENSITY...

A RESOLUTION WILL COME.

A BEAUTIFUL ACHING



A BEAUTIFUL ACHING

T THIS IS HEADY STUFF

The reason that this may feel like Heady Stuff is because of the natural inclination to “*Work This Out*”. Which is fine, because it is part of the process that leads to Understanding and this is the precursor to Knowing.

An aspect of “*Working This Out*”, is processing the information. Processing information is just calculating an outcome to an equation, this is something machines are very good at.

Machines can calculate equations endlessly and the equations can even get more and more complex over time. But when all is said and done, the machine is still, only calculating equations.

Yet, there is one thing the machine cannot accomplish, no matter how many equations it solves or however complicated those equations become.

The machine can never Understand the equation, because the machine is subordinate to the equation. It is the equation that drives the machine.

Understanding the equation, is Transcending the equation.

The machine does nothing without the equation and the equation is useless without the machine.

Hence, the machine can never Understand how and why the equation works.

Thus, the machine can never reach a state of Understanding, so it can never attain a state of Knowing.

*

A BEAUTIFUL ACHING

BRING AWARENESS TO THE INNER CONFLICT...
FACE AND ALLOW THE INTENSITY...
A RESOLUTION WILL COME.



A BEAUTIFUL ACHING

WHAT'S LOVE GOT TO DO WITH IT?

Tina's song is great, but it is wrong. Love is not a *"Second-Hand Emotion"*.

In fact, Love is not an Emotion at all.

Love is the driver of all Emotion and more.

Yes, Love makes One feel happy, joyous, peaceful.

But cannot Love also make One feel sad, angry, restless?

As far as Creation goes, all Creative Expression is an Expression of Love. It could even be said that all Expression is an Expression of Love.

An Artists creation is an expression of love, an Engineers design is an expression of love, a Writers story, a Singers song, a Chefs dish...

But to Create, is it not also necessary to Destroy? In all of the above examples and many others, is something not destroyed, at some level, so something new could be created?

The mere act of Expression means Love is at play, somewhere.

Now, One may ask,

*"But what about all the violence in this world,
where is the Love there?"*

Violence is an Expression of an inability to accept suffering, an unwillingness to face pain.

From the verse, [Unrequited Love](#), can it not be seen that pain is just an indication of Unrequited Love?

A BEAUTIFUL ACHING

So, does Love = Consciousness? Does Consciousness = Love?

Can a difference be found?

DEFINITION

Violence – In this context, Violence is defined as violating Another's sovereignty against their will, using physical force.

*

BRING AWARENESS TO THE INNER CONFLICT...
FACE AND ALLOW THE INTENSITY...
A RESOLUTION WILL COME.



A BEAUTIFUL ACHING

THE OVERVIEW

These first few verses to this point, have set the foundation for what is to come. They have been an overview of the subject matter and the topics that are to be presented. There is a great amount of detail and nuance to investigate and this will develop with each subsequent verse.

The Overview verses are intended to bring about a new perspective and to stimulate the questions that need to be asked. They do not provide all the answers nor, do they ask all the questions, because then the Overview would never end.

The Overview verses, in their intended reading order, are as follows:

1. [What's In A Name?](#)
2. [Unrequited Love](#)
3. [The Conflict](#)
4. [The Destructive Solution Explored](#)
5. [The Creative Solution Explored](#)
6. [The Fundamental Process Of Nature](#)
7. [This Is Heady Stuff](#)
8. [What's Love Got To Do With It?](#)

The point of all the information that will be presented here is not to simply comprehend what these words and sentences imply, what is most important is to know the state from which these words and sentences come from.

For these words and sentences can be considered to be nothing more than road signs to the destination, or even postcards from the destination.

A BEAUTIFUL ACHING

They are not the destination itself.

*

BRING AWARENESS TO THE INNER CONFLICT...,
FACE AND ALLOW THE INTENSITY...,
A RESOLUTION WILL COME.



A BEAUTIFUL ACHING

GRACE

*Grace Is Not
The Crown You Wear.*

Grace is Simple,
but is not simplistic.

Grace is Elegant,
but is not gaudy.

Grace is Effortless,
but is not lazy.

Grace is Integrity,
but is not self-righteous.

Grace is Fearless,
but is not domineering.

Grace is Trust,
but is not gullible.

Grace is Resilient,
but is not stubborn.

Grace is Attractive,
but is not ostentatious.

Grace is Unapologetic,
but is not spiteful.

A BEAUTIFUL ACHING

Grace is an Expression,
but is not a performance.

.

Of all the things that Grace is and is not,
Ultimately, Grace is,
The Crown of Divinity.

DEFINITIONS

Simple – Efficient, uncomplicated.

Simplistic – Basic, unrefined.

Attractive – Attracts attention.

Unapologetic – Grace is Unapologetic in being Grace. This does not apply to the context of a smug, unapologetic fool.

*

BRING AWARENESS TO THE INNER CONFLICT...
FACE AND ALLOW THE INTENSITY...
A RESOLUTION WILL COME.



A BEAUTIFUL ACHING

S STRENGTH

*Strength Is Not
The Sword You Carry.*

The Strength that is being referenced here is not a physical strength, but a Strength of Character, an Inner Strength and it comes about when One allows themselves to be Vulnerable.

Much like a flower allows itself to be Vulnerable just so it can display its beauty and express its fragrance. Not for any reason of vanity and ego, but simply because this is what is in its Nature and in this state of Vulnerability, it allows Truth to be expressed through it.

But the flower is a fragile and delicate thing and in the course of its life it will be scorched by sun, pelted by rain, savaged by storms; yet it will not complain nor play the victim. Instead, it will continue to display its beauty and express its fragrance, regardless.

At any time, the flower can be squashed in an instant or uprooted mercilessly. But even this, does not dissuade it from being a flower.

Then, the moment may arrive when it is crushed, its life ended, its resilience finally overcome and still, for a few moments longer, it will continue to express its fragrance, not apologising for being a flower.

And thus, the flower is Powerful.

Even when faced with its own destruction, it still does not deny, that it is simply, a flower.

*

A BEAUTIFUL ACHING

BRING AWARENESS TO THE INNER CONFLICT...
FACE AND ALLOW THE INTENSITY...
A RESOLUTION WILL COME.



A BEAUTIFUL ACHING



WISDOM

*Wisdom Is Not
The Books You Read.*

The premise of Wisdom is built on the foundational recognition of the interplay between Dualistic aspects, without any preference for either counterpart.

Light/Positive and Dark/Negative support and aid each other in the advancement of Life and Understanding. Just like the Inward and Outward breath promotes and advances the life and health of the physiological body.

Darkness can be considered unpleasant and difficult, but this in and of itself is not inherently “*Evil*”.

Light can be considered pleasant and comfortable, but this again does not make it inherently “*Good*”.

It is the denial of this symbiotic relationship from either side that initiates a corruption and if the denial is strong enough, then what is referred to as “*Evil*” ensues.

*It is not always recognised
that the Self-Righteous
can be just as Evil as the Wicked.*

For instance, forcing an Outward only breath would soon create an unbearable situation for the physiological body and eventually, natural mechanisms would override this condition, causing an involuntary Inward breath.

A BEAUTIFUL ACHING

This involuntary Inward breath would then need to be deep and intense to counteract the effects of the unnaturally prolonged Outward breath. In turn, the body's physiological systems would be in a state of upheaval for a period of time, attempting to reach a natural, dynamic equilibrium once again.

If adamant and persistent in pursuing this course, all manner of perverse actions may be utilised in exclusively promoting the Outward breath, each resulting in failure and each failure requiring a more drastic response. Ultimately, the only way to destroy the Inward breath is to also destroy the Outward, which obviously means death to the physiological body itself.

Conversely, the same holds true.

Wisdom does not favour the Outward breath, nor the Inward, but allows for the natural flow of one into the other, unhindered.

*One that is Sane never feels
joy at the suffering of Another.*

*One that is Wise understands that suffering
is sometimes the Nature of Things.*

So, in terms of Dualistic counterparts, it seems more appropriate to counter-pose Evil with Wisdom rather than "Good".

*

BRING AWARENESS TO THE INNER CONFLICT...

FACE AND ALLOW THE INTENSITY...

A RESOLUTION WILL COME.



A BEAUTIFUL ACHING

TEACHING VS INDOCTRINATING

TEACHING

Teaching is based on creating an environment and situation where a student's innate Understanding and abilities are drawn to the surface, developed and refined.

The methodology for this is where the teacher presents the student with the teacher's own Understanding and abilities, in a manner that will stimulate and inspire the student to learn and develop these same Understandings and abilities, from their own perspective.

The ultimate goal being, that at some point in time the student will attain the same level of Understanding as that of the teacher and eventually surpass the teacher. Hence, becoming a teacher themselves and continuing the cycle.

This is how the natural Human experience develops and grows.

INDOCTRINATING

Indoctrinating is where a predefined set of political, ideological or religious standards are programmed into a programming vessel, so the vessel can then regurgitate predictable responses and behaviours whenever stimulated to do so.

One of the methodologies used to achieve this is through exhaustive repetition. Where the programming vessel must either repeat mind numbing operations or be exposed to repetitious statements and actions. To the point that when prompted for a response, the vessel automatically expels or enacts what is required of them without question or any thought of dissension.

To make this even more effective, physical, emotional or psychological manipulation techniques can be utilised if the vessel does not produce the required response in a manner that satisfies those manipulating the indoctrination process.

A BEAUTIFUL ACHING

This then sets up a behavioural pattern that whenever a vessel is presented with a condition or situation that is opposed or not within the framework of their programming, they may react in a very emotional or even violent manner.

The most effective results are produced when the indoctrination process is initiated on a programming vessel that is in the infant stages of development and rigorously continued on into early adulthood. Then systematically reinforced throughout the lifetime of the programming vessel.

At no point is the vessel to ever challenge those that oversee the indoctrination process.

At no point is the vessel to ever exceed the authority of those that oversee the indoctrination process.

The programming vessel will always be a programming vessel, until the time comes that their limited understanding and abilities are no longer required, upon which they will be discarded or even disposed of.

Indoctrination will often obscure itself by hiding behind the masks of *“teaching”* and *“schooling”*, because what semi-sane Individual would knowingly send their children to be *“educated”* in an Indoctrination Centre?

Teaching is a process of drawing out, developing and refining innate, natural Understanding from within.

Indoctrinating is programming and enforcing a predefined political, ideological or religious standard from without.

*

BRING AWARENESS TO THE INNER CONFLICT...
FACE AND ALLOW THE INTENSITY...
A RESOLUTION WILL COME.



A BEAUTIFUL ACHING

CREATION IS A NINCOMPOOP

Humans have intelligence. *(Yes, I know what you're thinking.)*

Humans are a part of Nature, an outcome of the Creation.

Supposedly, the Creation has no Intelligence. It is just some collection of accidental, random events that brought about the Creation.

This implies the Creation is just a dumb and clumsy nincompoop. But with all its seemingly idiotic bumbings, it still manages to Create something Extraordinary.

Yet Humans, with all their intelligence, only understand the Creation in the most simplistic and superficial of ways.

So, if the Creation has no Intelligence, where then did Humans get their intelligence from?

How can the Creation bestow a quality on to one of its outcomes, that it does not possess itself?

How is this possible?

*Entropy is the general trend of the Universe
toward death and disorder.*

James R. Newman

A BEAUTIFUL ACHING

Some see this sort of definition as proof that Creation is nothing more than a random accident. Because things are observed to eventually decay into a state of seeming Disorder, this somehow proves that there is no Order.

So, what is essentially being said is that there is no Order in the structure and functioning of all plants, animals, sentient life forms, ecosystems, planets, star systems, galaxies...

Wait... What?!

If the only thing going on in the Universe is things decaying into Disorder, where then did all this Order come from to begin with?

Simply put, if there is no Order, then there is nothing to decay into Disorder.

But there is Order, so what is Creating this Order?

Insanity Cannot Create Beauty.

A “*creator*” that mandates they be glorified and worshipped by their creation, presents as being highly insecure and quite definitely insane.

How then, is it possible for such a “*creator*” to create anything of actual beauty?

Insanity cannot even conceive of anything beautiful, let alone create it.

So, it is an important thing to consider; does Creation or a Creator need to be worshipped?

Because...

Insanity Cannot Create Beauty.

*

BRING AWARENESS TO THE INNER CONFLICT...
FACE AND ALLOW THE INTENSITY...
A RESOLUTION WILL COME.



A BEAUTIFUL ACHING

DUALISTIC COUNTERPARTS

For reference purposes, the following list of Dualistic counterparts is presented. This is not a complete list, just a sampling.

Creation	Destruction	Powerful	Vulnerable
Masculine	Feminine	Active	Passive
Male	Female	Honesty	Deception
Light	Dark	Reveal	Conceal
Day	Night	Comfort	Discomfort
Dawn	Dusk	Safe	Dangerous
Birth	Death	Ascend	Descend
Positive	Negative	Attack	Defend
Right	Left	Awake	Asleep
Pleasant	Unpleasant	Forward	Backward
Attractive	Repulsive	Begin	End
Outside	Inside	Below	Above
Hot	Cold	Courage	Cowardice
Expression	Absorption	Demand	Supply
Inhale	Exhale	Hope	Despair
Expand	Contract	Dry	Wet
Source	Sink	Rough	Smooth
Predator	Prey	Open	Closed
Joy	Anger	Even	Odd

Happiness	Sadness	Heads	Tails
Clarity	Confusion	Horizontal	Vertical
Calm	Conflict	Object	Environment
Stability	Turmoil	Subject	Context
Strength	Weakness	Space	Time

The final four entries on this list may seem a little strange,

- Horizontal and Vertical.
- Object and Environment.
- Subject and Context.
- Space and Time.

HORIZONTAL AND VERTICAL

If Dualistic counterparts are considered opposite expressions of one another, then how are a Horizontal and a Vertical line opposite?

Perpendicularity is as opposite as two lines can be. As soon as the angle between the two lines shifts from being perpendicular, the lines start to becoming parallel, which means that they are becoming alike.

Two Perpendicular lines which overlap or intersect each other is one of the most basic symbols for Duality. Such a symbol is generally referred to as a Cross. A Cross or an “X” is also often used to represent Conflict.

OBJECT AND ENVIRONMENT

Considering that Dualistic counterparts cannot exist without one another, like Heads and Tails of a coin, then it can be seen that an Object cannot exist without an

Environment and an Environment would be worthless without at least one Object in it. So, when examined from this perspective, an Object and an Environment are very much Dualistic counterparts.

Also, the Object is often an Environment for other smaller objects and an Environment is usually contained within a larger space or Environment, thus it becomes an Object itself.

SUBJECT AND CONTEXT

A similar explanation as above can be made for a Subject and a Context. The Context is simply the environment in which the Subject is expressed.

SPACE AND TIME

Space and Time are Dualistic counterparts because neither aspect can be defined independent of one another. Space cannot exist without Time and Time cannot exist without Space. This will be expanded upon in the verse, [Understanding Space/Time](#).

Counterpart pairs also create context for one another, for example, Darkness gives context to Light and vice versa. What would Light mean if there was no Darkness?

Dualistic counterparts, from an overall Energetic perspective, are also never in equal balance, they exist in a continual state of asymmetric flux. Always positing to create perfect balance but never achieving this state, thus the constant flow and movement within the Universe.

AN INTERESTING OBSERVATION

If the term “*Individual*” is broken down into its components of “*Indivi*” and “*dual*” then it can be observed that,

- Indivi – Is the shortening of the word “*Indivisible*”, which means incapable of being divided.
- Dual – Is the shortening of the word “*Duality*”.

A BEAUTIFUL ACHING

So, the term “*Individual*” or “*Individuality*” can be defined as an Indivisible Duality.

What does this mean?

Just an interesting observation.

DEFINITION

Individual – A Unique Fundamental Sovereign Self-Aware Expression of Singularity.
An Indivisible Duality. This definition is for the word as a noun, with a capital “*I*”.

*

BRING AWARENESS TO THE INNER CONFLICT...
FACE AND ALLOW THE INTENSITY...
A RESOLUTION WILL COME.



A BEAUTIFUL ACHING

THE ELECTRIC CIRCUIT ANALOGY

Consider an electrical circuit that has been designed and manufactured to comfortably operate at 1 Volt and it achieves what is required of it at this 1 Volt source input.

If however, 1.5 Volts were to be applied to this circuit, it may soon become apparent that the circuit functions warmer than its normal operating temperature. It may also operate in a more erratic and excited manner and generally become more unstable.

Increasing the source voltage to 2 Volts would most likely see this circuit become very warm, even to the point that components and interconnections fail or disintegrate. The circuit may no longer function at all because its design conditions have been well exceeded with this increase in intensity.

Now, what if the circuit had a way to adapt to these increases in energetic intensity? Could it adapt to handle 5 Volts, 100 Volts, 1 000 000 Volts?

No, the circuit itself has no ability to adapt its circuitry.

However, the Human Being has the capacity to adapt to higher Energetic states.

The only requirement being, is to *“Face and Allow the Intensity”*, the rest takes care of itself.

Because the deeper the Awareness, the higher the Energy state and vice versa.

ATTENTION

The above verse is an analogy, One must not directly subject themselves or others to any form of electrical energy. The Energy being referred to in the Human experience is of a different sort and nature altogether.

A BEAUTIFUL ACHING

*

BRING AWARENESS TO THE INNER CONFLICT...
FACE AND ALLOW THE INTENSITY...
A RESOLUTION WILL COME.



A BEAUTIFUL ACHING

T THE DARK CUPBOARD

Consider two Individuals that have grown up living in a dark cupboard their entire life and this dark cupboard also happens to be located in a deep dark basement.

What if somehow these two Individuals managed to hear about a thing called, the “Sun”? Then they may well spend their time discussing and debating the existence and merits of this, “Sun”. They could postulate all sorts of theories and philosophies surrounding the idea of the “Sun” and even formulate equations proving or disproving any or all of these theories and philosophies.

Alternatively, they may go the route of ignoring reasoning altogether and simply create an object of worship. They could then ascribe all sorts of qualities and abilities to this object of worship, being only limited by their imagination.

But what if they instead, opened up the cupboard door, walked up out of the basement, went outside and looked at the daytime sky?

Now, what if only one of these Individuals bothered to leave the cupboard, walk outside and look at the daytime sky? What if this Individual then returned and informed the Other of what they had observed? Would their discussion then be based on philosophy, or science, or religion, or would it simply be, a description?

When discussing Truth, it is not philosophical, nor scientific, nor religious, but descriptive.

Because Truth is a Discovery, not a head game.

Also, in the case of Discovering Truth, it is an Inward journey not an Outward one.

CLARIFICATION

The aspect of science that is being referred to here is Scientific Theory not the Scientific Method. The Scientific Method has validity in this context.

A BEAUTIFUL ACHING

*

BRING AWARENESS TO THE INNER CONFLICT...
FACE AND ALLOW THE INTENSITY...
A RESOLUTION WILL COME.



A BEAUTIFUL ACHING

THE SPRING SCALE ANALOGY

Consider a spring-loaded bathroom scale. This scale, like many of its type, has a rotating disk with markings on its surface which reference certain weight values. Above this disk sits a transparent viewing window with a thin line, usually red, etched centrally onto its surface and its purpose being to indicate the relevant weight value on the rotating dial below.

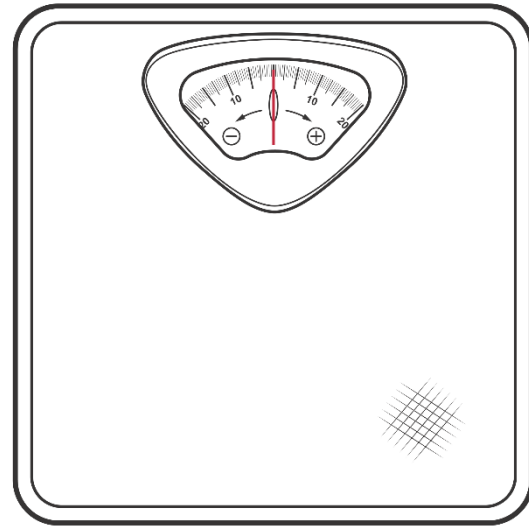

POLARITY SCALE
MEASURING INTENSITY

As an object of a certain mass is placed on to this scale, the dial rotates anti-clockwise from its zero position to the appropriate value that represents the weight of the item placed on it. Then once the item is removed, the dial rotates clockwise, back to the indicated zero position.

Now, let's make some modifications to this scale (refer to the associated image). Instead of having the freedom to only move anti-clockwise from zero, the dial can also move clockwise from the zero position. Furthermore, let's assign the term "*Positive*" to values to the right of the zero and "*Negative*" to values to the left and these values will denote Intensity rather than Weight.

So essentially, the zero designates the central position of the disk, with Positive and Negative values on opposite sides and the disk can rotate in either direction.

In the nominal position, the red etched line on the surface of the viewing window sits above the zero mark on the dial. If some type of Positive element is placed on this scale, the dial will move anti-clockwise and rest at the point that represents the Intensity of this Positive element. The magnitude of the Intensity will be indicated by the value on the dial that lies directly below the red etched line.

A BEAUTIFUL ACHING

If this same process was to be repeated with a Negative element, then the magnitude of its Intensity would be shown with the dial moving clockwise to the appropriate value.

The red etched line, in this case, portrays what is meant by the term “*Detachment*”. It has no preference in the direction that the dial rotates, nor does it have a partiality for the Intensity value which is presented to it. In a sense, it is simply Aware of the Polarity and magnitude of Intensity offered by the rotating disk.

Emotions are a valuable indicator and feedback mechanism for the Polarity and Intensity of certain Energy states. Neither Emotional polarity is “*Good*” or “*Bad*”, although they can be accurately described as being Pleasant and Unpleasant.

Acceptance of suffering has nothing to do with “*coping mechanisms*” and other such adulterations. It is about genuinely experiencing what is being genuinely presented, without any attempt to dissipate or morph the Emotional experience in any way.

Also, activities like self-flagellation which intentionally induce suffering upon Oneself are unhelpful. They are a senseless practice encouraged by psychotic Individuals.

*

BRING AWARENESS TO THE INNER CONFLICT...

FACE AND ALLOW THE INTENSITY...

A RESOLUTION WILL COME.



A BEAUTIFUL ACHING

THE THUG, THE COWARD

The thug is One that is so terrified of feeling Vulnerable, that they over compensate to the extreme. They create the persona of being overly aggressive so as to frighten off Others or to intimidate them into submission and if this does not work, they then revel in using violence against those that are not willingly subjugated.

Hypocritically, the thug will often be the first and the loudest to cry “*Injustice!*” when they themselves are exposed to their own treatments and actions.

The thug also likes to coalesce into collectives or gangs, because of the consternation they feel from a backlash against their own thuggery. This is also why many thugs are drawn to authoritarian institutions and agencies, so they can wear authoritarian titles and authoritarian issued costumes to give themselves legitimacy.

Resolving the fear surrounding the thug, disarms the thug and makes the thug impotent.

This is something the thug cannot stand.

Because the Thug is a Coward.

*If the first option One looks for
in any Conflict is violence,
guess what they will find
in every Conflict?*

*

A BEAUTIFUL ACHING

BRING AWARENESS TO THE INNER CONFLICT...
FACE AND ALLOW THE INTENSITY...
A RESOLUTION WILL COME.



A BEAUTIFUL ACHING

UNDERSTANDING SPACE/TIME

Consider a circle.

This circle encloses an area or a Space.

A Space implies movement, because what would be the purpose of the Space, if there were no ability to move within it.

Now, a unique physical object cannot be at two distinct points in that Space at exactly the same Time.

For a physical object to move from one point in that Space, to another point in that Space, requires Time.

Hence if Space exists, then Time exists and vice versa. But if one is absent, both are absent.

If the Space between two points is increased, but the speed of movement between those points remains the same, then the Time to move between one point and the other also increases.

Thus, Space/Time is referred to as a continuum. The greater the Space, the greater the Time.

Expressed in a more general sense, a change or variation in one aspect of a Dualistic relationship corresponds to a change or variation in the other.

There is however one point in that circle where Space/Time does not exist, where no movement is possible at all.

That is, the absolute centre of the circle.

At the absolute centre of the circle there is no area, meaning there is no Space and therefore no Time.

A BEAUTIFUL ACHING

The only thing that is found there is Stillness, Silence, Singularity.

But the centre of the circle is fundamental to the creation of the circle, because the circle does not exist without the centre.

So, there is a paradox, from the Source of Stillness the entire dynamic Universe is birthed.

Also consider, that every point within the circle is a potential centre of a new circle.

TIME

Asking the question, *“When did Time Begin?”* or making the statement, *“The Beginning of Time”* makes no sense, because this implies that at some point in Time, Time began.

For Time to have a Beginning and an End would indicate that Time already prevails. It suggests that Time would have to exist within an envelope of Time.

There cannot be a Beginning of Time. There cannot be an End of Time.

There can only be a Beginning and an End to the things that emanate within Time.

Time itself is a functional mechanism within the framework of Eternity.

*

BRING AWARENESS TO THE INNER CONFLICT...

FACE AND ALLOW THE INTENSITY...

A RESOLUTION WILL COME.



A BEAUTIFUL ACHING

THE UNIVERSE IS HOW OLD?

There is a generally accepted concept that the Universe has an age.

But what does this mean?

If the Physical Universe is defined in terms of Space/Time and Space and Time are a continuum, in which the two aspects cannot be defined independent of one another, how then can the Universe have an age?

For the Universe to have an age, Space would have to exist within an envelope of Time. Meaning, that at some point in Time there was no Space but then, at another point in Time, there was.

However, as is demonstrated in this previous verse, [Understanding Space/Time](#), Time does not exist without Space, so there is no period in Time where Space did not exist.

Therefore, the Universe cannot have an age.

Even if Time did exist without Space, what then existed in the Time interval between Space not existing and existing?

Within what environment does Time existing without Space?

Time implies movement, Space implies movement. Both aspects are inextricably tied to movement.

Referencing the Universe as a whole in terms of Time is meaningless, only the contents of the Physical Universe can have a meaningful Time reference.

It cannot even be stated that the Universe is Ageless, because this too is meaningless. This implies that the Universe is Timeless, therefore Spaceless.

So, perhaps the best way to describe the Universe is that it simply, **IS**.

*Creation did not come
from somewhere.*

*Creation is not going
to somewhere.*

Creation, IS.

THE UNIVERSAL MODEL

The current generally accepted model of the Physical Universe is comprised of,

1. Planet – Potentially may have smaller satellites or moons in orbit.
2. Star System – Planetary bodies orbiting a central star.
3. Galaxy – Countless star systems orbiting a galactic centre.
4. Universe – The collection of all galaxies.

But this is incomplete and the term Universe is used incorrectly in this case, because there is also discussion of there being many Universes or a Multi-verse.

The expanded model of the Physical Universe that is alluded to in these pages is,

1. Planet – Potentially may have smaller satellites or moons in orbit.
2. Star System – Planetary bodies orbiting a central star.
3. Galaxy – Countless star systems orbiting a galactic centre.
4. Primary Verse – The collection of all galaxies within the particular Primary Verse.

5. Secondary Verse – The collection of all Primary Verses within the particular Secondary Verse.
6. Tertiary Verse – The collection of all Secondary Verses within the particular Tertiary Verse.
7. This Primary, Secondary, Tertiary... sequence continues indefinitely.
8. Universe – The collection of all of the above. Because “*Uni*” means One or the Whole.

This model now shows the Infinite Fractal nature of the Physical Universe.

DEFINITION

Fractal – The definition of a Fractal from the American Heritage Dictionary of the English Language, 5th Edition.

- An object whose parts, at infinitely many levels of magnification, appear geometrically similar to the whole.
- A geometric figure that repeats itself under several levels of magnification and that shows self-similarity on all scales.

*

BRING AWARENESS TO THE INNER CONFLICT...

FACE AND ALLOW THE INTENSITY...,

A RESOLUTION WILL COME.

A BEAUTIFUL ACHING



A BEAUTIFUL ACHING

THE TRANSCENDENCE OF TRUTH

There is a tendency to equate “*Truth*” and “*Lie*” as Dualistic counterparts. Instead, it would be more accurate to associate Honesty and Deception as Dualistic counterparts in this context.

Truth itself has no Dualistic counterpart. Truth is Transcendent.

A crude definition for Truth would be, “*What IS*”.

Truth is the foundation upon which Duality/Reality is built.

Truth is not “*What Will Be*”, nor is it “*What Was*” as these two conditions imply Birth and Death, which are themselves Dualistic counterparts.

Truth is always Alive. Truth is Life. Truth is the Present. Life only exists in the Present.

“*What IS*”, is the Present.

“*What Will Be*”, is yet to be Born.

“*What Was*”, is Dead.

*A Fact is simply the
memory of a Truth.*

If a Lie is defined as a Deception, then as was stated, it is the Dualistic counterpart of Honesty.

A BEAUTIFUL ACHING

If a Lie is defined as an untruth, then a Lie cannot exist, because an untruth is a contradiction.

Creation contains many paradoxes but it does not contain a single contradiction. Any perceived contradiction is not an error of Creation, it is an error in observation and in the Understanding of *“What IS”*.

If untruths or contradictions existed then there would be holes in the foundation of Reality, which would make for a very unstable Reality.

One cannot avoid Truth forever because illusion/delusion has a finite time span. Eventually, Conflicts will emerge that will resolve the delusion and nothing burns away delusion, like Intensity. Thus, the ultimate result of this Inner inferno, is Clarity.

Knowing Truth comes from a state of Inner Clarity, not from knowing everything.

Discovering and Expressing Truth is akin to walking down the street, seeing what is around, what attracts attention and describing it from this state of Inner Clarity.

Truth is independent of personal belief. Truth does not care what One believes. Truth goes on being Truth, regardless.

Because...,

Truth IS.

*To Discover, Understand and Know Truth,
is to allow the experience of..*

What IS.

CLARIFICATION

It should be noted that a Deception is not necessarily nefarious.

An insect that camouflages itself against its background to deceive predators, is legitimate in its actions.

A predator that is hunting prey for food may also use deceptive techniques to achieve its end.

In these cases, like many of this type, the Deception is real, it does exist and is justifiable.

So, can these even be considered a Lie?

*

BRING AWARENESS TO THE INNER CONFLICT...
FACE AND ALLOW THE INTENSITY...
A RESOLUTION WILL COME.



A BEAUTIFUL ACHING

HOPE AND BELIEF

Belief = Unexplored Ignorance.

Ignorance = Ignoring Truth.

*Exploring Ignorance does not mean
looking for ways to justify Belief.*

*Exploring Ignorance means
genuinely questioning Belief.*

“Hope” and “belief” are facades the ego creates when it encounters situations and ideas it cannot cope with nor Understand.

When the search for Wisdom and Truth is discarded, it is replaced with “hope” and “belief”, which are nothing more than cheap conveniences.

“Belief” is easy, there is little to no effort or angst required to manufacture a “belief”. There are no real Conflicts that need be resolved, there is no real turmoil One must navigate.

When One “believes”, One simply pretends that the Conflicts do not exist.

“Belief” itself is a hindrance to the discovery of Truth. One can “believe” $7 \times 7 = 53$ and with that “belief” they convince themselves that no further investigation or contemplation is necessary, because “I believe” and that’s good enough.

To Discover and Understand, One must first recognise that One does not Know. But “belief” is nothing more than a pretending to Know.

To Understand and to Know takes great effort, commitment, courage, resilience and even then, there are no guarantees.

A BEAUTIFUL ACHING

So, it is somewhat understandable that so many are content to just “*hope*” and “*believe*”.

Often, the Wisest thing One can acknowledge is,

I don't Know.

“Belief” is the result of a lack of genuine inquiry for Truth.

“Belief” is cheap, “belief” is lazy, “belief” is a coward.

*Those who can make you believe absurdities,
can make you commit atrocities.*

Voltaire

*

BRING AWARENESS TO THE INNER CONFLICT...
FACE AND ALLOW THE INTENSITY...
A RESOLUTION WILL COME.



A BEAUTIFUL ACHING

NATURE, THE ALGORITHM

Creation is the materialisation of the Universe from Singularity. Singularity's manifest, resonant reflection.

Nature is Creation's Algorithm that oversees the functioning of the Universe by directing and co-ordinating all expressions of Life Force/Consciousness.

Nature's Prime Directive is to create circumstances and situations which contribute and add to Understanding and Knowing.

Duality is the structural framework in which all this takes place.

One expression of this is in the Predator/Prey interplay or survival of the fittest. Those organisms that adapt to the ever-changing conditions survive, while those that cannot, perish.

However, being the biggest most ruthless thug on the block does not necessarily ensure survival. In fact, this approach may lead to a rather quick demise, as other organisms identify the threat and take swift action against it.

Nature's role is to not only promote and sustain Life, but to also enhance it and make it prosper. Yet to do this, it must challenge Life, by providing purposeful obstacles to overcome and creating Conflicts with meaningful consequences.

Meaningful consequences create a high degree of urgency to stimulate learning, creativity, adaptation and resourcefulness.

Those Individuals and species that most accurately comprehend this and are able to best adapt to the dynamic situational context, prosper.

But prosperity in this sense does not mean simply creating cushions and buffers against the effects of Nature, instead requires the Wisdom and Understanding to work in conjunction with Nature.

A BEAUTIFUL ACHING

Nature carries out this role without fear nor favour for any individual organism or species within Creation.

Worshipping or praying to some deity is not going to garner any special privilege from Nature. Although there are parasitic entities which encourage and consume the Energy from these types of activities.

*Power is not derived
through the attempted
dominance of Nature.*

*Power is discovered upon
a deep acceptance of Nature.*

DEFINITION

Algorithm – In the context of this blog, an Algorithm is a device or structure that produces a repeatable Output for a given Input. Examples of which are,

- A See-saw – With a see-saw, when one end is pushed down the other end goes up. This result is repeatable while the see-saw is intact and functioning correctly.
- Computer Program – A computer program is a logical device or structure which produces a certain Output for a given Input. The whole point of a computer program is that it is reliably repeatable.

Nature already knows the most efficient way to a required outcome.

It can be observed that Nature is efficient in all aspects that are currently somewhat understood. Thus, would it not be reasonable to accept that Nature is efficient in all its aspects and all its expressions? It makes no sense otherwise, why would Nature be efficient in some areas but not in others?

Does it not also make sense then that Nature will get One from where they are now, to where they need to be, at the time One needs to be there, in the most efficient manner feasible? Even though, in hindsight, it may seem as though the path is rather convoluted.

Not only that, Nature is mandated to co-ordinate the requirements and activities of all things, in all of Creation, in the most effective and efficient way possible. The scope of which is beyond the Human intellect to fully comprehend.

So, from a Human perspective, a personal quality that is helpful in navigating this endless, intermingling labyrinth, is Inner Trust.

ASKING THE QUESTION

Expression is the Voice
and the Voice asks the Question.

The Question interacts with Universe
and is transformed by Universe.

This transformation is the Answer,
the Answer to the Question.

However, the underlying issue is...

Will the Answer be Heard?

*

BRING AWARENESS TO THE INNER CONFLICT...,
FACE AND ALLOW THE INTENSITY...,
A RESOLUTION WILL COME.

A BEAUTIFUL ACHING



A BEAUTIFUL ACHING

R REAL CHANGE

*The role of the Individual is not
to obstinately change themselves
or the world around them.*

*The role of the Individual
is to Understand themselves
and the world around them.*

From an Inner perspective, Real Change is something that is allowed, not something that is done.

For the One embarking on the journey, there are no specific pathways that can be mapped out as transitions to the change. Because Real Change is unknown, so the pathway cannot be outlined prior to the transition. Real Change goes into areas that have not been explored as yet, so the pathway does not exist as yet.

Real Change is a discovery of both the path and the destination.

Moving to a state or condition that One is familiar with, is not Real Change.

Real Change is when there is unfamiliarity with the situation or circumstance One finds themselves entering into.

Real Change, on any level, can be quite difficult to contend with. But this is especially the case when it comes to a change in the Inner condition, a transitioning to higher Energy states.

Engaging fears and insecurities is mandatory and Real Change will cause anxiety and trepidation. Although this passes as One becomes accustomed and acclimatised to the new state.

A BEAUTIFUL ACHING

If the process of change feels comfortable and easy, then it is not Real Change.

*Explore, Discover,
Understand, Know.*

*

BRING AWARENESS TO THE INNER CONFLICT...
FACE AND ALLOW THE INTENSITY...
A RESOLUTION WILL COME.



A BEAUTIFUL ACHING

THE MEANING OF CONTEXT

Q. What gives a measuring device,
such as a ruler, Context?

A. Zero! Without zero
the measuring device is useless.

Q. What gives a measuring device Meaning?

A. The units. Without the units
the measured values are
nothing more than arbitrary numbers.

One must be Aware of where zero is and its relation to the measured value, such as the units, to have any meaningful frame of reference for the Subject being measured.

Meaning comes when defining the Subject relative to and in terms of the Context.

Understanding comes when there is a comprehension of Meaning.

Awareness anchored at the Source/Singularity gives One's life true Context and Meaning.

Awareness that is not anchored at the Source/Singularity is like a point in a co-ordinate system that is oblivious to its own origin.

“Who am I?”, “What am I?”, “Where am I?”, “What is this place?”.

It is Lost.



THE MEANING OF CONTEXT
THE CO-ORDINATE SYSTEM

SEARCHING FOR...

Philosophy is the search for...

Science is the search for...

Religion is the search for...

.

Q. What does One call it
when the search ends?

A. A Discovery.

.

Q. How does One Express
the Discovery?

A. Through Definition
and Description.

.

Q. And what is Ultimately
being searched for?

A. Context and Meaning.

CLARIFICATION

Singularity itself is not in search of anything.

Singularity is the Observer and the Observed.

For Singularity to be conducting a search, presupposes what is to be found.

Singularity has no expectation for what is to be found.

Singularity simply Observes and allows the Discovery to unfold.

*

BRING AWARENESS TO THE INNER CONFLICT...
FACE AND ALLOW THE INTENSITY...
A RESOLUTION WILL COME.



A BEAUTIFUL ACHING

T THE INFINITY COIN

Consider the situation where One is being offered a \$1 coin.

However, this offer only appeals if One can have just the Head side of the coin. One refuses to accept the Tail side of the coin because it offends them and is unpalatable to them.

Well, in such a circumstance One may not be able to accept the coin at all.

Yet One really does want the Head side of the coin, so they finally accept the whole coin, even the Tail side. The desire for the Head side makes them begrudgingly put up with and endure the Tail side of the coin.

Now, One has enjoyed the Head side of the coin and is being offered a \$5 coin. But again, they must accept both sides of the coin if they are to have the coin at all.

The conundrum. The Head side of the \$1 coin was Pleasant but was it Pleasant enough to offset the Unpleasantness of the Tail side? Is it worth accepting this more valuable coin?

This is an important consideration, because One will now receive five times the Pleasantness from this new offering than what was received from the original, but also five times the Unpleasantness.

“What to do?”

For Awareness to transition to higher and higher Energy states a very similar scenario is at play. Energy requires a Dualistic charge interaction to flow, both Positive and Negative, both Heads and Tails. One must accept the Whole for Awareness to pass through the gateways to these higher Energy states.

So, the Ultimate Question,

“Is One prepared to accept the Infinity Coin?”

A BEAUTIFUL ACHING

The Infinity Coin can only be received when there is no longer any resistance nor hesitation to accepting the Whole Coin.

Both the Head and Tail sides are to be welcomed, without preference.

*

BRING AWARENESS TO THE INNER CONFLICT...
FACE AND ALLOW THE INTENSITY...
A RESOLUTION WILL COME.



A BEAUTIFUL ACHING

T THE STRUCTURE OF INTEGRITY

Integrity in the context of a physical construction, such as a bridge or a building, refers to the structure's capacity to support not only its own weight, but also its ability to support loads that are placed on it.

If the structure has the ability to hold itself together while carrying loads that are within or even beyond its design targets, then it can be said that the structure has Integrity.

If the structure is unable to support even its own weight or shows signs of failure under loads that are far less than its design targets, then the structure can be considered to be of poor Integrity.

A structure that is of poor Integrity is deemed ineffective and unsafe because it is seen as a danger to all other objects around it.

In the Human context, those Individuals that express genuine Integrity will carry their loads and burdens safely and effectively, not capitulating and destroying themselves or those around them.

While those that lack Integrity will crumble in on themselves and seek to offload their own burdens and responsibilities on to others. They may also make claims about themselves that cannot be substantiated, in an attempt to project a false facade, as they blame others for their own deficiencies and failings.

This, at its core, is an Expression of an inability to cope with the burden and Intensity of the Inner Conflict.

Just because One maybe experiencing "*Hell*" does not mean One must be corrupted by it.

Those that have Integrity will not only endure the suffering that comes from the Inner Conflict, but will Transcend it.

A BEAUTIFUL ACHING

Those that lack Integrity will succumb and capitulate to the suffering and be corrupted by it.

Thus, “*Hell*” plays its role in separating the wheat from the chaff.

Ultimate Integrity does not simply carry the load or bear the burden, but Transcends it, to the point that it becomes effortless.

One can appear to have Integrity when there is no load being applied. However, the true test comes, when considerable duress is encountered.

The Question is, can One bear the load, the burden and achieve Transcendence, without intoxicating or destroying the experience as a way to avoid the suffering?

*

BRING AWARENESS TO THE INNER CONFLICT...

FACE AND ALLOW THE INTENSITY...

A RESOLUTION WILL COME.



A BEAUTIFUL ACHING

THE INFINITY OF SINGULARITY

In this verse the terms Singularity and Universe (as in Uni-Verse) will be used synonymously and are referencing the Absolute Whole. However, it is more accurate to state that Universe/Creation is the resonant reflection of Singularity.

*Words are Finite.
Sentences are Finite.
Language is Finite.*

*How is the Infinite to be described,
when only Finite methods are available?*

If Universe were to be defined in some way, then this definition would imply that Universe has a boundary. Because all definitions, by their very nature, are defining boundaries.

But if Universe has a boundary, then the next logical question is,

“What is beyond this boundary?”

Because a boundary is a separation and as such it is separating at least two items, states or conditions.

The fact that there is a boundary means that the entire Universe has not been fully defined within the particular definition. It means the definition is omitting some aspect of Universe.

A BEAUTIFUL ACHING

In other words, a definition can only define a part of Universe. No definition can define the whole of Universe, because the mere act of defining creates a boundary and a boundary is a separation, an isolation of a portion of Universe/Singularity.

Consequently, a definition which encompasses the Absolute Whole is not possible. Universe/Singularity cannot have a boundary, thus cannot be defined.

Also, the finite is definable because there is a boundary. The Infinite is undefinable because there is no boundary.

So, with Singularity being undefinable, Singularity is Infinity.

Hence, The Infinity of Singularity.

*Silence is the
Echo
of Infinity.*

For something to have Form it must have a definable boundary.

Form is simply the shape or structure of a particular boundary.

It has been shown that Singularity has no boundary.

Therefore, Singularity has no Form.

*Stillness is the
Reflection
of Eternity.*

*

BRING AWARENESS TO THE INNER CONFLICT...
FACE AND ALLOW THE INTENSITY...
A RESOLUTION WILL COME.



A BEAUTIFUL ACHING

A AVOID STRESS AND ANXIETY?

Avoid Stress and Anxiety.

This sort of advice is frequently given with the intent of improving One's health and well-being. But what does this mean and is that really the outcome of such advice?

Generally speaking, Psychological/Emotional stress is not a switch that is turned off and on at will.

Psychological/Emotional stress, in and of itself, is not a health problem, it is an indication of Inner Conflict.

Chronic, unresolved Inner Conflict begins to break down the Psyche and eventually the Emotional and Physical bodies as well. This is the health problem.

Stress and Anxiety are to be resolved not avoided. Avoidance creates the chronic issue.

Stress can have a stimulating and rejuvenating effect once the Inner Conflict has been resolved.

An effective method to improve and maintain Physical health is high intensity exercise.

Exercise is a stress on the Physical body. It stimulates the Physical body into an adaptive response, which then leads to an improvement in health and well-being.

However, chronic exercise creates chronic Physical stress and eventually a breakdown of the Physical body will result.

Relatively short exposure to high stress produces the adaptive response. Rest is required to allow the adaptation to manifest.

A BEAUTIFUL ACHING

The difference between Physical and Psychological/Emotional stress is that Physical stress from exercise is allowed and even welcomed, whereas Psychological/Emotional stress is treated like an illness that must be shunned and avoided.

*

BRING AWARENESS TO THE INNER CONFLICT...
FACE AND ALLOW THE INTENSITY...
A RESOLUTION WILL COME.



A BEAUTIFUL ACHING

T THE DANGLING CARROT

There may come a time in One's life
where a Dangling Carrot is discovered.
Their Dangling Carrot.

The Carrot
that is there
to tempt,
to entice,
to toy.

The Carrot
whose mere existence
mocks,
enrages,
shatters.

All the while
the Carrot goes on,
just,
being the Carrot.

Initial attempts
to reach the Carrot,
clumsy,
awkward.

*"Keep it cool",
"Don't look desperate".*

But failures feed desperation.
Desire to attain feels urgent.

Perplexed.
Confused.
Frustrated.

Efforts to reach,
to touch,
in vain.

Stretching.
Pleading.
Failing.
Again.

Universes exist
within millimetres of separation.

Impossible.
Hopeless.

Why bother?
Why try?

Treasures of disappointment,
the only reward.

...

Curse these hands,
these arms,
this body.
Useless they are,
such a simple task.

Curse this situation,
this Life,
this World.
A more pointless existence
cannot be conceived.

...

Panic!

...

Okay.
Try again!

Other options?
None.

The Carrot must be had.
There is nothing else.

Failing once more,
cannot be considered.

SO REACH...

Stretching hard.
Sweat beads.

Not even close.

MORE!

Veins balloon.

Skin flushed.

Not even trying.

MORE!

Muscles quiver.

Tendons fray.

Is this even serious?

MORE!

Bones creak.

Joints swell.

Still not enough.

MORE!

Heart strains.

Breathing stops.

...Maybe?

MORE!

Nose bleeds.

Cells scream.

So very close.

MORE!

Vision blurs.
Awareness fades.

**ALMOST THERE.
MORE!**

Carrot shifts...
One millimetre...
Two.

...

...

...What now?
...What is there?

Start again...?
Move on...?

Keep Going...?
Give up...?

Pain at any level is an Expression.

*Allow it to Speak
and Listen to what it has to say.*

*

BRING AWARENESS TO THE INNER CONFLICT...
FACE AND ALLOW THE INTENSITY...
A RESOLUTION WILL COME.



A BEAUTIFUL ACHING

ANATOMY OF THE HUMAN BEING

Anatomy of the Human Being is a series of verses that will provide a general outline of the elements that make up the Human Being and give an overview of the functioning of each element.

The structural makeup of the Human Being is as follows,

HUMAN PSYCHO-BIOLOGICAL ORGANISM

- Physical Body.
- Emotional Body.
- Psychological Body or Psyche.

HEART CENTRE

Connection point or interface between the Human Psycho-Biological Organism and Mind/Spirit.

MIND/SPIRIT

The term Mind/Spirit is being used due to a lack of a more appropriate term. The term Mind in this context is not referring to brain function or mental chatter.

- Soul Consciousness.
- Universal/Creation Consciousness.
- Source/Singularity/Consciousness.

ENERGY NODE POINTS

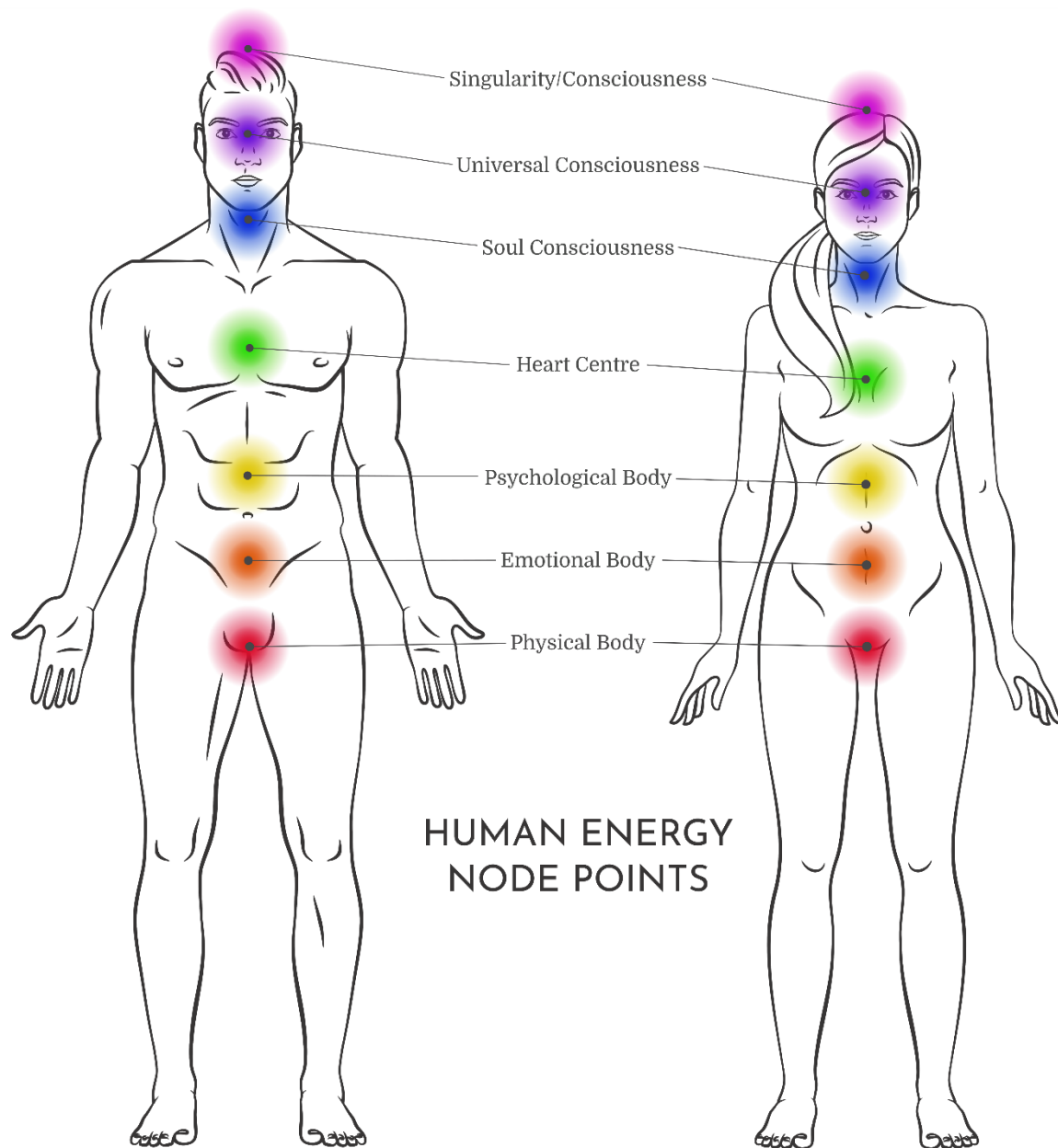

How these elements relate and interact is through Energy node points which correspond to regions of the body.

- Physical Body node point is the connection to the Earth.
- Emotional Body node point is the connection to the Physical Body.
- Psychological Body node point is the connection to the Emotional Body.

- Heart Centre node point is the connection to the Psychological Body.
- Soul Consciousness node point is the connection to the Heart Centre.
- Universal/Creation Consciousness node point is the connection to Soul Consciousness.
- Source/Singularity/Consciousness node point is the connection to Universal/Creation Consciousness.

Conceptually, these aspects of the Human Being can be considered as layers on top of one another or alternatively, in the form of circular rings that are concentric to one another, with Singularity being at the centre.

Other teachings and cultures have referred to these as “*Chakras*” and the terminology used here for some of these individual points may vary from those teachings and cultures.

Although the structural elements of these Energy nodes are present in each Human Individual, they are not necessarily operating at any meaningful capacity, let alone full capacity. Operational performance of these nodes is dependent on the level or depth of Awareness of the particular Individual. Most Individuals have a level of Awareness based within the Emotional Body Energy state and relatively few venture past this point in the course of a life time.

This series of verses will be split into two parts, with the Human Psycho-Biological Organism verses being presented in succession and the Mind/Spirit verses presented further along.

*

BRING AWARENESS TO THE INNER CONFLICT...,
FACE AND ALLOW THE INTENSITY...,
A RESOLUTION WILL COME.

A BEAUTIFUL ACHING



A BEAUTIFUL ACHING

THE HUMAN PSYCHO-BIOLOGICAL ORGANISM

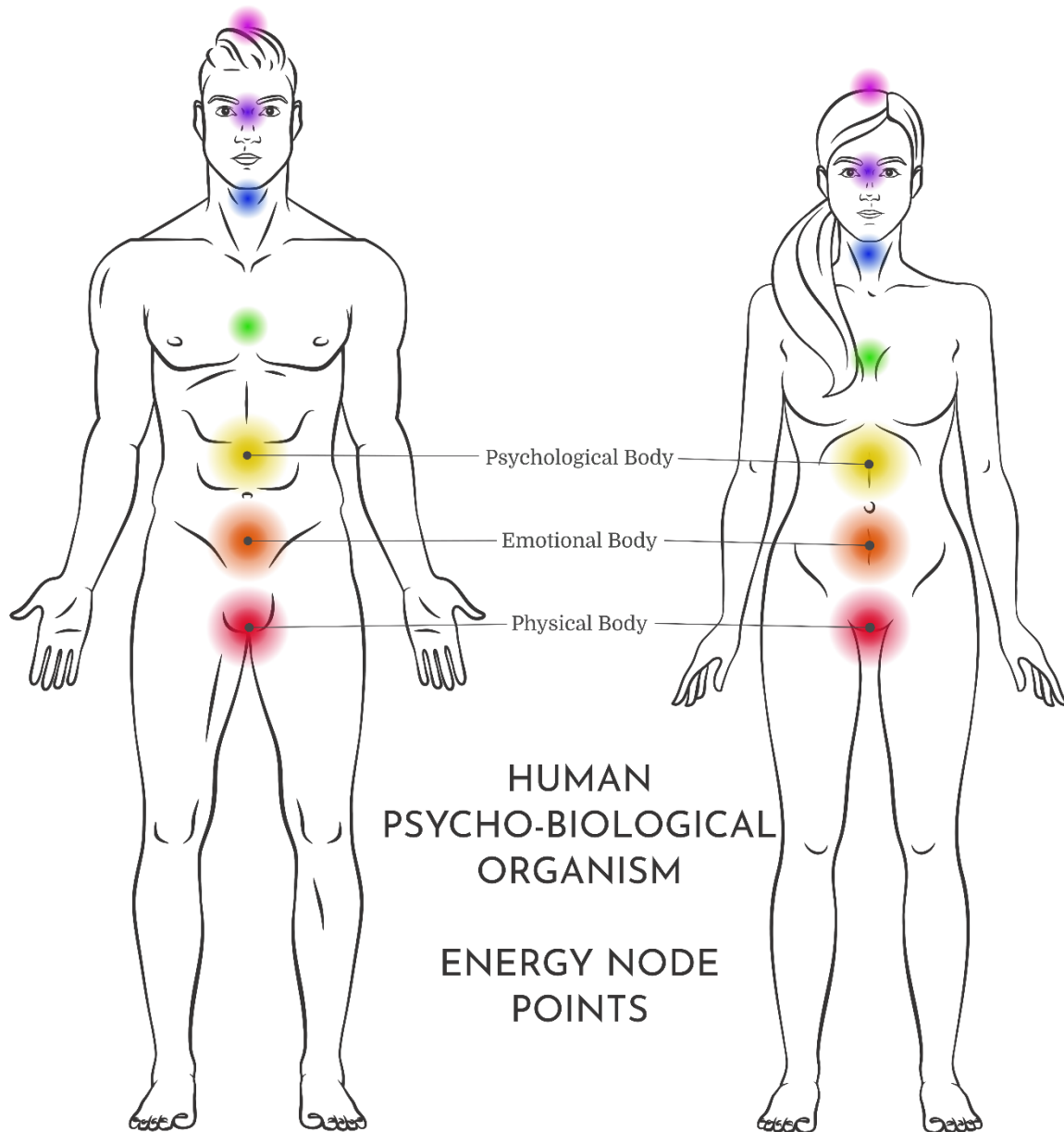

A BEAUTIFUL ACHING

The Human Psycho-Biological Organism is made up of,

- Physical Body.
 - Analogous system – Computer hardware including BIOS.
- Emotional Body.
 - Analogous system – Earth’s weather system.
- Psychological Body or Psyche.
 - Analogous system – Computer operating system like Windows, macOS, Linux.

This aspect of the Human Being could be referred to as the Human animal, although this term does not do it justice. The Human Psycho-Biological Organism is far more complex and sophisticated than any non-sentient animal and its spectrum of expression is exceedingly more diverse. Ranging from levels below that of any animal to the potential of Divinity, as in an unobstructed connection to Singularity.

MALE AND FEMALE EXPRESSIONS

HUMAN MALE

- Masculine Physical Body.
- Feminine Emotional Body.
- Masculine Psychological Body.

HUMAN FEMALE

- Feminine Physical Body.
- Masculine Emotional Body.
- Feminine Psychological Body.

*

BRING AWARENESS TO THE INNER CONFLICT...

FACE AND ALLOW THE INTENSITY...

A RESOLUTION WILL COME.



A BEAUTIFUL ACHING

THE PHYSICAL BODY

The Physical Body is the outer most expression of the Human Being, the densest of the three bodies. It is the material vehicle through which the material world is experienced.

This is what anchors all the other components of the Human Being into this reality.

An analogous system would be computer hardware. That is, the physical components of a computer system, including the BIOS/Firmware.

BIOS (Basic Input Output System) runs and controls the hardware components in a computer system, such as the CPU, memory, storage devices and also interfaces with other peripherals.

The nervous system of the Human Body is equivalent to computer BIOS, although it is orders of magnitude more sophisticated. It controls the hardware components of the Physical Body, such as the brain, the heart, the lungs, the reflexes, physical senses and many other systems and functions.

The endocrine system is also deeply integrated into control and signalling functionality.

The Human Physical Body is the biological instrument that runs the program, the algorithm of the Human Psyche.

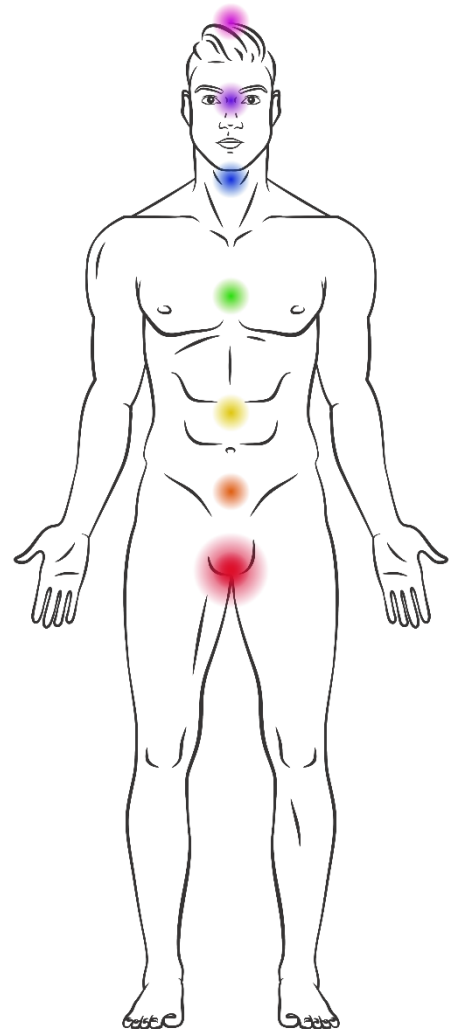

*

A BEAUTIFUL ACHING

BRING AWARENESS TO THE INNER CONFLICT...
FACE AND ALLOW THE INTENSITY...
A RESOLUTION WILL COME.



A BEAUTIFUL ACHING

THE EMOTIONAL BODY

The Emotional Body can be difficult to clearly define in a logical and rational sense, but its purpose cannot be understated as part of the whole Human experience.

The general functions of a correctly operating Emotional Body can be summed up in the following ways.

- The Weather System of the Psycho-Biological Organism.
- Inner Conflict Indicator and Feedback.
- Sensory Device to indicate the state of a situation or environment, such as being safe or dangerous.
- A Measure of Personal Value.

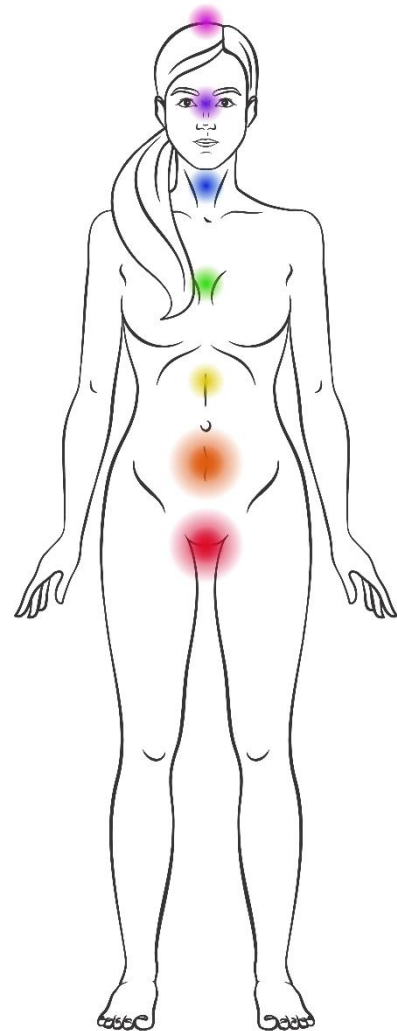

THE WEATHER SYSTEM

In many ways Emotions are analogous to the Earth's weather systems. Comparably, weather systems help promote the life, growth and experiences of biological life forms. While Emotions help promote the life, growth and experiences of the Human Psycho-Biological Organism. In fact, Emotions do this for any complex animal.

Weather systems provide the constantly changing environmental conditions which stimulate and drive growth. Just like the weather is sometimes fine, sunny and calm, but at other times it is rough, dark and stormy, Emotions possess a very similar quality in this regard.

A BEAUTIFUL ACHING

Storms may represent unstable weather conditions and potential destruction, but they also have a clarifying and cleansing effect. When One experiences the moments after a thunderstorm, there is often a refreshing sense in the air. This is especially the case after a thunderstorm which proceeds a long period of hot, dry weather. Plants and other life forms spring to life from these invigorating effects.

When One experiences the turmoil bought on by an intense Inner Conflict, the resulting Creative resolution can also have a stimulating and rejuvenating effect on the Individual in question. The serene period that follows, allows for rest and recovery to take place, along with any adaptations to manifest.

INNER CONFLICT INDICATOR AND FEEDBACK

Inner Conflicts are usually indicated by Emotions like fear, insecurity, stress, anxiety. Any Emotions that have a strong attachment to a particular desire or outcome.

But upon resolution of an Inner Conflict, lighter more pleasant Emotions will be the feedback response.

For more about stress and anxiety and the connection to Inner Conflict, please refer to the verse, [Avoid Stress And Anxiety?](#)

SENSORY DEVICE

The sense of dread in a particular situation or the feeling of peacefulness in a certain surrounding are sensory indicators of conditions that are either dangerous or safe.

These can trigger physiological responses such as *“Fight or Flight”*, in preparation for the body to act quickly and decisively in avoiding or subduing a particular danger. Or there is the counter to this, with the calmness experienced in a safe environment, which can stimulate the body to rest and recover.

The Emotional Body can also be a very accurate device for the measurement of Honesty and Deception, provided that it is calibrated correctly to begin with. More on this in the verse, [Calibrating For Truth.](#)

A MEASURE OF PERSONAL VALUE

Of course, the aspect of the Emotional Body that will be very familiar is its expression of personal value. The people and objects that One most value's will also provide the most potent Emotional experiences.

A child will provide a strong Emotional experience for a parent, both in a Pleasant and Unpleasant way. Children will be a source of great joy for parents, but will potentially also cause great distress. The children of Others may evoke an emotional response, but it will not be on the same level as that of One's own children.

The passing of a loved one will arouse levels of sadness which correlate to the value and meaning that the departed had to the particular Individual. However, there is very little sadness felt towards the passing of a person that One has no affection for.

A further example is when One experiences a passionate and romantic relationship with Another. There is always high potency in these exchanges, both in a loving and possibly volatile nature.

A Psycho-Biological Organism that is weighed down by a sub-conscious state of perpetual fear, will invariably have an Emotional Body that is not operating correctly and the above-mentioned functions can be severely hindered and confused.

Or put another way, a backlog of sub-conscious, unresolved Inner Conflicts can interfere with the correct functioning of the Emotional Body, particularly if there is strong resistance against any resolution taking place.

*

BRING AWARENESS TO THE INNER CONFLICT...,
FACE AND ALLOW THE INTENSITY...,
A RESOLUTION WILL COME.

A BEAUTIFUL ACHING



A BEAUTIFUL ACHING

T THE PSYCHOLOGICAL BODY

The Psychological Body is equivalent to the operational software of the Human Psycho-Biological Organism, the behavioural program/algorithm of the biological instrument and the term “*Human Nature*” is referring to this Human psychological program.

It not only contributes to the survival and reproductive functions of the Human Psycho-Biological Organism, but also to the inquisitive and creative aspects in artistic and technological endeavours.

Obviously, this program is not uniform across all Individuals and just like there is a Human Physical Body archetype, with many feature variations, there is also a Human Psychological Body archetype, with expressive variations. These expressive variations are commonly referred to as the “*Personality*”.

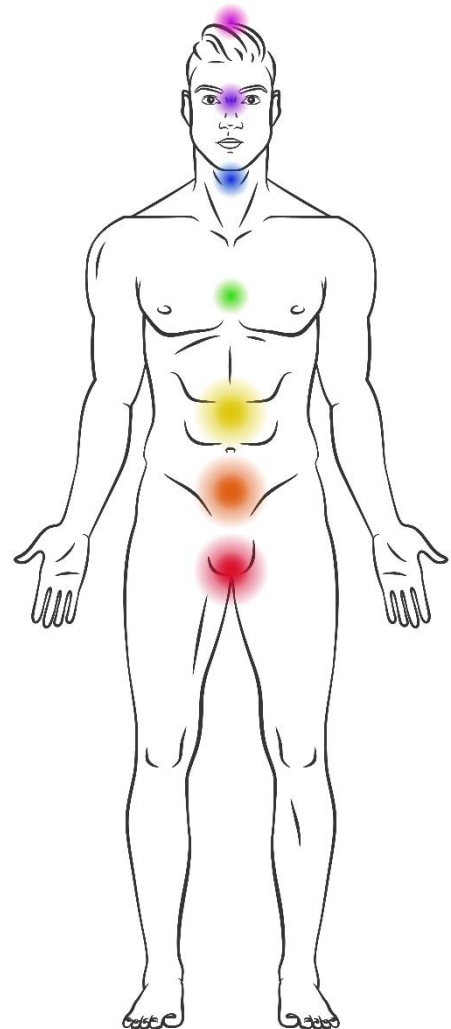

A BRIEF OVERVIEW

This outline is presented with the intent to expand on some of these points in future verses.

- The Psychological Body, just like the Physical Body, may become ill and dysfunctional in its own way and the effects of this dysfunction can and does spread to the Emotional and Physical Bodies as well.
- The types of things that cause the Psychological Body to become ill and dysfunctional are chronic fear and trauma that are then compartmentalised within the Psychological Body like a cancer, which results in suppressed Inner Conflict.

A BEAUTIFUL ACHING

- Suppressed Inner Conflict causes the Psychological Body to become disfigured, contorted and burdened with these innumerable wounds, which then leads to distorted and contradictory beliefs/programming as a way to avoid dealing with the pain that they hold. This is similar to the way One would avoid any contact on a sensitive and infected physical wound.
- In this state the Psychological Body is susceptible to Psychological Malware, just like a compromised computer operating system would be.
- Psychological Malware takes the form of various types of manipulation, examples of which are ideological indoctrination, propaganda, fear mongering and gas-lighting.
- This level of sub-conscious chronic fear and trauma that drives Inner Conflict, is not something that is created in a single life time, but is passed on through genetic transfer to offspring. A parent's unresolved Inner Conflicts are transferred to the child at the time of conception and from this, an accumulation effect begins.
- The genetic capacity to accumulate suppressed chronic trauma is limited and eventually a tipping point is reached where the Human Psycho-Biological Organism must unload, but ideally in a safe and "*controlled*" fashion.
- From countless generations of accumulated, unresolved chronic trauma there is the situation that is observable today. A biological species that has reached the accumulation capacity of the organism and now the unloading begins. Thus, a world gone mad.

THE STUDY OF PSYCHOLOGY

Currently, the study of psychology is limited in its Understanding because it has no idea or concept of what is beyond psychology. It does not see how psychology fits into the greater scheme of the Human Being. In fact, it is not even Aware of the full make-up of the Human Being.

It is trying to Understand the program from an Awareness that is at or below the level of the program, it has not yet Transcended the program to be able to comprehend

proper context. As an analogy, a fish cannot comprehend the ocean because it is too busy swimming around in the ocean and is not able to elevate its Awareness above it.

A related verse that may be of interest is, [This Is Heady Stuff](#).

*

BRING AWARENESS TO THE INNER CONFLICT...
FACE AND ALLOW THE INTENSITY...
A RESOLUTION WILL COME.



A BEAUTIFUL ACHING

CHARACTERISTICS OF THE THREE BODIES

This verse is a very general guide to the types of characteristics that may be conveyed by an Individual whose Awareness range spans the Human Psycho-Biological Organism. These characteristics are ones that are most prominent and may not be as pronounced in the vast majority of Individuals that express a similar scope of Awareness.

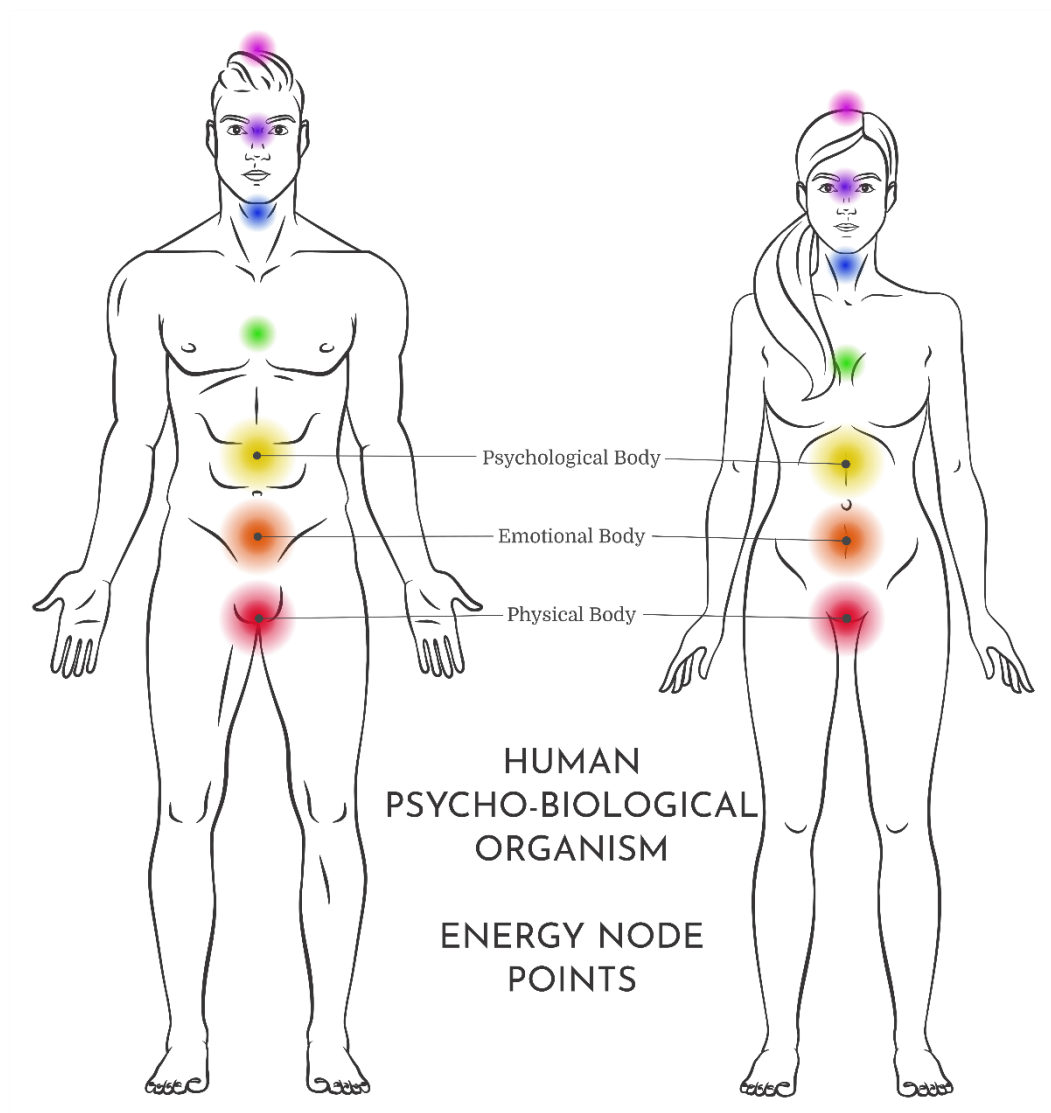

This perspective is for informative purposes only and is not intended to be used as a way to categorise, demean or abuse others. Those that would use this material in that manner most likely have an Awareness state that is even more restricted than those they wish to vilify.

MASCULINE AND FEMININE

First off, a basic Understanding of Masculine and Feminine Energy forms and flows for Natural systems needs to be established.

Masculine Energy forms are Expressive.

Feminine Energy forms are Receptive.

This construct then sets up the mechanisms of Energy flow between Energetic polarities.

In terms of the more dense, materialistic Energy states, Energy flows from the Masculine to the Feminine.

At the more refined, higher frequency Energy states, Energy flows from the Feminine to the Masculine.

This exchange mechanism is aptly portrayed in the way water falls from the clouds to the ground in its denser, liquid state; while rising up to form the clouds in its amorphous, vaporous state.

The issue with current Understanding is that only the Masculine aspect of Energy flow is mostly recognised and the Feminine aspect is either unknown, vague or obscured. That is, Energy is seen to only flow in a Positive to Negative direction, but not from a Negative to Positive direction also.

This is an important facet that is being missed.

THE PHYSICAL BODY

Male – Masculine Physical Body.

Female – Feminine Physical Body.

An Awareness limited to the Physical Body may express the following characteristics;

- Tendency for the “*Macho Male*”/ “*Girly Girl*” types. This is due to the lack of expression from a counterbalancing Emotional Body.
 - Males may tend to an exaggerated masculinity. Some could even see and describe themselves as “*Alpha Male*”.
 - Females may tend to an exaggerated femininity and will often overly sexualise themselves.
- Subdued Emotional experience, limited Emotional capacity due to an underdeveloped Emotional Body.
- Could also manifest as blunted Emotional expression, meaning that Emotional expression lacks nuance and refinement. That is, it is very polarised.
- Emotional experience may be replaced with obsessive stimulation of the physical senses and endocrine function.
- Very much a Physical Body and material world focus.

THE EMOTIONAL BODY

Male – Feminine Emotional Body.

Female – Masculine Emotional Body.

An Awareness limited to the Emotional Body may express the following characteristics;

A BEAUTIFUL ACHING

- Counterbalancing expression to the Physical Body.
 - However, if the Emotional Body expresses in a greater disproportion to the Physical Body, then the Individual may exhibit exaggerated characteristics of the opposite gender, due to the gender reflection of the Emotional Body.
 - In other words, a Male may present as being effeminate while a Female may present more masculine traits.
 - In certain circumstances homosexual tendencies may result, because Energetically the Masculine is always looking to connect with the Feminine and vice versa.
- The Emotional Body dominates behaviour with Awareness confined to this level.
- Greater Emotional capacity as the Emotional Body develops. Though this may lead One to be Emotionally reactive as part of the adaptation process.

THE PSYCHOLOGICAL BODY

Male – Masculine Psychological Body.

Female – Feminine Psychological Body.

An Awareness limited to the Psychological Body may express the following characteristics;

- Greater Emotional capacity, although still not fully developed.
- Somewhat of a detachment from Emotions. That is, not so Emotionally reactive.
- A more developed and proportional gender expression which corresponds to the gender of the Physical Body.

- Any homosexual tendencies diminish as the Psyche develops and the strong Emotional Body is counterposed with a gender expression that correlates with the Physical Body.
- A more developed personality, but still not whole.
- Greater tendency to be Self-Reflective.
- More cognisant of personal behaviour and the effects and consequences of behaviour.

As Awareness transitions through the gateways between these bodies, One may or may not even be mindful of the transitions, since the capacity to recognise these has yet to properly develop. An Awareness limited to these levels is tuned to perceive more dense, low frequency experiences.

The main Understanding to gain from this verse is that wherever on the Human Consciousness spectrum One finds their Awareness currently situated, remember to engage and explore. Explore every corner, explore every aspect, explore every dead end. But when Awareness is compelled to move on, allow it to do so. Know that turmoil will come as Awareness shifts and it is helpful to not be too resistant to the impending change.

A verse that outlines these types of transitions is, [Real Change](#).

Allow the Inner Turmoil.

Another important consideration is that One not let themselves be too attached to behaviour or defined by behaviour, because what is mostly being described here, is only behaviour. Endeavouring to find the Source and not stopping until it has been reached, is what all this is really about.

Currently, the vast majority of Individuals in this world express an Awareness that sits within the Psycho-Biological range and the majority of those are within the realm of

A BEAUTIFUL ACHING

the Emotional Body. Maybe in the not too distant future, this will shift closer toward Singularity.

To reiterate again, this perspective is for informative purposes only and is not intended to be used as a way to categorise, demean or abuse others.

Those that feel compelled to do so are encouraged to read the verse, [The Thug, The Coward.](#)

*

BRING AWARENESS TO THE INNER CONFLICT...
FACE AND ALLOW THE INTENSITY...
A RESOLUTION WILL COME.



A BEAUTIFUL ACHING

CALIBRATING FOR TRUTH

As was mentioned in the verse, [The Emotional Body](#), the Human Psycho-Biological Organism is an excellent instrument for the measurement of Honesty and Deception, provided that it is calibrated correctly.

The term “*Calibration*” is generally used to denote the process of aligning a measuring device against a known, well defined standard.

For example, the “*metre*” unit of length is currently based on the speed of light in a vacuum as 299,792,458 metres per second. Thus the “*metre*” is defined by how far light travels in a vacuum in $\frac{1}{299,792,458}$ of a second.

Calibration of the Human Psycho-Biological Organism is achieved in a similar manner. If an instrument is being calibrated for Honesty and Deception then the best and obvious standard for this is Truth, because of the fundamental Nature of Truth, see [The Transcendence Of Truth](#).

For One to be able to accurately determine the varying levels of Honesty and Deception in the world around them, One must first calibrate themselves to the standard of Truth.

So how does One go about accurately calibrating against such a standard?

By clearing Oneself of all Self-deception and Self-delusion, however small.

It is these falsehoods and fallacies that condition the Individual with a distorted standard to measure Honesty and Deception by.

Once all Self-deception and Self-delusion has been resolved and eliminated, the only thing left is Truth. Because there is nothing else, Truth itself cannot be eliminated. Truth may be hidden, it may be obscured, it may be misrepresented, but it can never be destroyed.

A BEAUTIFUL ACHING

It is also valuable to dispense of the notion of “*My Truth*” and “*Your Truth*”. This is a misguided technique to mischaracterise Truth as a Subjective opinion, a way of justifying Self-deception and Self-delusion. Refer to the verse, [Objective Truth](#).

The primary factors that contribute to Self-deception and Self-delusion are,

- Fear – Truth is too uncomfortable or painful to accept.
- Insecurity – Pandering to One’s own insecurities as a way to avoid Inner Conflict.
- Addiction – Physiological dependencies such as substance abuse.
- Biases and Prejudices – An over attachment or obsession with Emotional preferences.
- Belief – Psychological conditioning or programming to fit a certain ideology.

All these elements affect the Individuals ability to have a precise frame of reference for Truth, because they cloud and skew One’s perceptions, thus resulting in poor accuracy when it comes to determining levels of Honesty and Deception.

Another related aspect to consider here is; why are political and religious institutions so heavily invested in promoting [Hope And Belief](#)?

They perpetuate the idea that “*Salvation*” is only available through their particular avenue, though they may not express it in this exact manner. But what is not often noticed is, that their avenue is actually a roundabout, in which an Individual can find themselves lost, indefinitely.

Below are links to related material. These are short pieces from the [Exygen](#) writings. (see Appendix C)

- [Charter – Supplemental Post 8 – Power Corrupts](#)

- [Charter – Supplemental Post 10 – True Leaders vs Political Rulers](#)
- [Charter – Supplemental Post 11 – Heaven And Hell](#)

*

BRING AWARENESS TO THE INNER CONFLICT...
FACE AND ALLOW THE INTENSITY...
A RESOLUTION WILL COME.



A BEAUTIFUL ACHING

FOUNDATION OF DUALITY

Singularity is “*One and Only One*”, the Source and the Absolute Whole. There is not multiple Singularities, however Singularity has two foundational aspects to it.

1. Singularity is the Origin of the Universe, the Zero Point, the Source and this aspect will be referred to as the Universal Origin and designated by (0). It provides the Context for the Universe. Please refer to the verse, [The Meaning Of Context](#).
2. Singularity is the Whole Universe, which refers to all the things within the Universe and this aspect will be referred to as the Universal Whole and designated by (1). It is the collection of all the Subjects, Fragments or Boundary States which make up the Absolute Whole. Another important thing to Understand here is that the Universe is Infinite because no boundary can be placed around it. Please refer to the verse, [The Infinity Of Singularity](#).

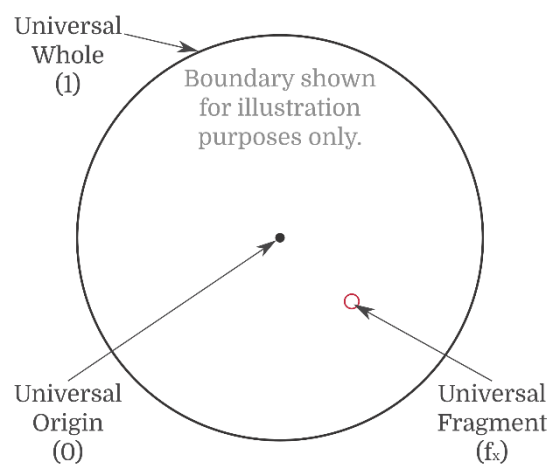

SINGULARITY MODEL
THE CIRCLE

From these two points, Singularity is not only the **SOURCE** of all things, it **IS** all things. It is both the Zero (0) and the One (1). It is Everything and it is Nothing, as well as being Infinite. This then, is what sets the foundation of Duality within the Universe.

A BEAUTIFUL ACHING

Also, it is important to Understand that these aspects are Qualitative differences, not Quantitative. This means that they are expressing a different Quality of Singularity, they are not making any Quantity or value statements about Singularity. They are not referring to the numbers 0 and 1.

To help clarify this, the Singularity Model diagram above shows that the origin of the circle cannot be detached from the circle as a whole, otherwise the circle ceases to exist.

The circle is the origin and the origin is the circle. They are simply two aspects of the same thing.

Now, everything within Universe/Singularity is a division of Universe/Singularity, a Fragment of the Universal Whole. Along with that, the process of division creates boundaries and these boundaries are the basis of the Finite Nature of manifest reality. Additionally, being divisions of Singularity, these Fragments will display the same Dualistic characteristics as Singularity itself.

As an aside, the reason that these Fragments are Finite is because Infinity is the True Reality and the Finite is the illusion. Illusions are transitory, illusions have their moment, but eventually, all illusion dissolves back into the Nothingness of the Whole.

Continuing on, each one of these Fragments is a unique, individual piece, there is not two exact same Fragments which occupy the same space and time as one another. In the same way, each piece of a cut cake is a unique and individual piece of cake that cannot co-exist in the same space, at the same time as another piece.

These Fragments within the Universal Whole will be designated by (f_x) or Universal Fragment and when referencing a specific Fragment, the x will be assigned a number such as 1, 2, 3..., as in (f_1) , (f_2) , (f_3) . So in the example of the cake, (f_x) is referencing the pieces of cake, whereas (f_1) references specific piece 1 of the cake.

These terminologies and designations will be used in an upcoming verse and are presented here to provide a foundation on which to build.

SUMMARY

- (0) = Universal Origin, Zero Point, State of Nothingness, Singularity Source, Context.
- (1) = Universal Whole, Infinity, State of Everythingness, Singularity Universe, Subject.
- These are Qualitative aspects of Singularity; they represent the Everything and Nothing of Infinity. They do not represent numerical value; they are not Quantitative like the numbers 0 and 1.
- (0) = (1) = ∞ , Since both are referencing Singularity. (∞ , Infinity Symbol)
- (f_x) = Universal Fragment, a division or boundary state within the Universe.
- (f_1), (f_2), (f_3), ... = A specific Universal Fragment.

CLARIFICATION

The Fragments discussed here are not disconnected shards of Singularity but are unique individual boundary states that are created by vibrational Energetic patterns. As Energetic frequencies shift and change, so do the boundary conditions and patterns that define these Fragments.

For more information on this phenomenon, One may be interested in researching the subject of Cymatics.

The Singularity Model diagram above may lead to the question,

“Where is the centre of the Universe?”

That is the equivalent of asking,

“Where is the centre of Infinity?”

A BEAUTIFUL ACHING

Given that the Universe is Infinity.

Well, the answer is...

Everywhere.

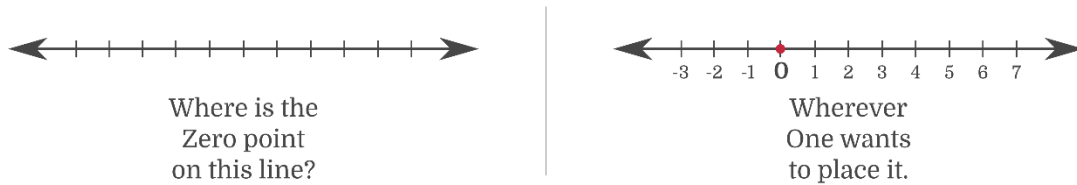

CENTRE OF INFINITY THE NUMBER LINE

*

BRING AWARENESS TO THE INNER CONFLICT...,
FACE AND ALLOW THE INTENSITY...,
A RESOLUTION WILL COME.



A BEAUTIFUL ACHING

CRASH THE ALGORITHM, PART ONE

All Algorithms/Programs, when presented with an Input, must express an Output. They have no choice in the matter, it is simply a part of their Nature. They are so bound by this rule that if an Input is received which the Algorithm is not set up to cope with, then that Input will crash the Algorithm itself.

A classic example of this, in fields like mathematics and computer science, is Division by Zero.

Division by Zero is a situation where an equation results in a number, any number, being divided by zero. This leads to an Output that mathematical equations and computer programs do not like very much and that Output is, *“Undefined”*.

This means that the equation or program has no idea about what to do with the particular Input, it has no notion of how to express an Output. So, if certain steps are not taken to deal with this type of situation, the outcome ends up crashing the particular equation or program.

This is the equivalent of a stalemate or an impasse, which has previously been mentioned in the verse, [The Conflict](#). Nature cannot allow these situations to linger unresolved, so it will ensure that a feasible solution is made available, or a crash will result.

Yet why is this the case? Why is something like the Division by Zero so problematic for an Algorithm?

The verse, [Division By \(0\), A Conceptual Exercise](#), explores a modified version of Division by Zero to help shed light on this.

But the basis of this dilemma is Self-Referencing.

SELF-REFERENCING

Self-Referencing is when an Algorithm is tasked with referencing itself to come up with a Solution to a Question. To demonstrate this, two comparative examples are shown in the table below.

EXAMPLE A	EXAMPLE B
Not Self-Referencing Valid Algorithm	Self-Referencing Invalid Algorithm
$a = 1$ $b = 2$ $c = ?$	$a = 1$ $b = 2$ $c = ?$
Procedure (<i>Add</i>) begin $c = a + b$ end	Procedure (<i>Add</i>) begin $c = \textit{Add} + b$ end
$c = 3$	$c = ?$

Example A shows a simple procedure to add two variables together and this procedure is called *Add*. The procedure begins and asks the Question,

*“What is the result of
adding the variables, a and b ?”*

Well, with a and b being assigned the numbers 1 and 2 respectively, the answer logically is 3. So the Algorithm assigns the Output variable c , with the value of 3 and then ends.

It can be considered that the procedure *Add* has the value of 3 at this instance.

This is a valid Algorithm because it is able to produce an outcome that is logical, based on the Question that is being asked.

Example B shows a procedure to add two variables together, but one of those variables is the procedure called *Add* itself. Therefore, the Question that this procedure is asking is,

*“What is the result of
adding myself to b?”*

The variable *b* is assigned the value of 2 but the procedure *Add* has not been assigned any value, with its task being achievable only when all the Input variables are independent of it.

The Algorithm is stuck because it does not Know what value it itself is, given that it has not determined its own value yet.

It is referencing itself without Knowing itself and it can never Know itself because it can never reference itself.

This is an example of a Question that requires the Answer to the Question as an Input to the Question to be able to Answer the Question. It is Infinitely Self-Referencing.

This Algorithm tends toward Infinity and that is what Crashes the Algorithm. Algorithms cannot handle Infinity, because Infinity freaks them out.

BOUNDARY CONDITIONS

Essentially, there is an invalid boundary condition to the Question that Example B is asking. All Questions require sufficient and appropriately valid boundary conditions within them, if they are to be Answered.

Questions with valid boundary conditions are generally of the form, “*Who...?*”, “*What...?*”, “*How...?*”, “*Why...?*”.

But even though the Question Example B is asking does contain a “*What...?*”, it is invalid because the “*What...?*” is leading to a Self-Referencing situation, so it actually has insufficient valid boundary conditions.

A BEAUTIFUL ACHING

A Question without valid boundary conditions or no boundary conditions, is just the Question Mark (?). Everything and Nothing is being asked all at once.

This type of Question is impossible for an Algorithm, Algorithms can only work within Finite spaces. They must be constrained to these Finite spaces by boundary conditions, or else they fail.

Infinity is a state in which no Questions are possible, because no boundaries exist.

One way to observe this phenomenon in the physical world is by having two mirrors face one another. The reflection that is observed within both of them goes on repeating forever. The reflections are Infinite, because the reflections are Self-Referencing.

An Algorithm cannot Self-Reference, it cannot Self-Reflect. But Understanding requires Self-Reflection and that is why an Algorithm can never Understand.

Consciousness has no problem with this, because Consciousness Transcends the Algorithm.

Consciousness is the Observer and the Observed, it is Self-Reflecting and Self-Reflection.

This is Understanding. This is Knowing.

CLARIFICATIONS

The two mirrors facing one another will bring up important Questions.

*“How can this occur
if Nature is an Algorithm?”*

And,

*“This is a Natural phenomenon,
so how does it not crash the Algorithm?”*

As was stated above, an Algorithm will crash if it is not set up to cope with an Input that may crash it.

Nature is setup to cope with this Input.

The effect that is observed in this situation is the equivalent to an escape routine, built into the Algorithm. It is there to prevent a crash, as it gives a glimpse into the True Nature of Consciousness.

It is an example of a visible, manifest Transcendence of the Algorithm.

An Algorithm itself does not actually recognise a Question at all. An Algorithm only sees and executes a process.

It is Consciousness that recognises the question as a Question and the answer as an Answer.

In the context of Creation, Nature is the Algorithm and Life Force/Consciousness or Energy Flow executes and animates the process.

*

BRING AWARENESS TO THE INNER CONFLICT...
FACE AND ALLOW THE INTENSITY...
A RESOLUTION WILL COME.



A BEAUTIFUL ACHING

CRASH THE ALGORITHM, PART TWO

All Human experiences are Inputs into the Algorithm of the Human Psyche and like all Algorithms, it must produce an Output of some sort or a crash will result.

These Outputs generally take the form of,

- Actions taken.
- Understanding gained.
- Creative inspirations.
- Acknowledging the Input.
- Remembering an Input.
- Mental Chatter.
- Dreaming.
- Emotional Expression.
- Physiological Response.

The above list is intended to convey the idea of what these Outputs are like and is not claiming to be all inclusive.

Pleasant or even moderately uncomfortable experiences are fairly straight forward for the Psyche and it has little issue in processing them in a conventional manner.

Traumatic Human experiences however, maybe more difficult to process and this is completely dependent on the robustness and resilience of the Individual Psyche in question. It would be extremely problematic and unsustainable if the Human Psyche crashed every time a traumatic event was experienced. This would leave the Human Psycho-Biological Organism in a dysfunctional state, unable to operate in any meaningful capacity.

So, there would need to be some sort of safeguard in place to avoid a total breakdown of the Psychological Body, if and when a severely traumatic event or situation is experienced.

Well, that safeguard is, Psychological Compartmentalisation.

This is a systematic process which psychologically quarantines the problematic experience. With the expectation that at some point in the future the Psyche will develop to a sufficient enough degree, that it can then process and resolve the core Conflict that the traumatic experience incited.

Experiencing a relatively small number of traumatic events in a lifetime is possibly not a significant issue and most Individuals currently living many not experience any events traumatic enough to cause the involuntary compartmentalisation of those experiences.

But when One considers the possibility that all Inner Conflicts must be resolved, as a mandatory prerequisite of the overriding Natural Algorithm, then it may be worthwhile to contemplate the following Questions,

*

*“What happens to these unresolved
Inner Conflicts if they are never resolved?”*

*

*“What if past generations experienced such
extreme and traumatic events on a global scale,*

that they have been long forgotten and deeply compartmentalised within the Human Psyche?"

*

"What if multiple such events occurred over the course of Human history, even beyond what is currently recorded, or even known?"

*

"What if this compartmentalisation then drives Psychological behaviour to avoid exposing these experiences, as a way of preventing complete Psychological shut-down.

But this inadvertently creates the situation that more and more compartmentalisation occurs, due to the slow breakdown of the Psyche?"

*

"What if this unresolved trauma is passed on from generation to generation through the reproductive process, because all Conflicts must be resolved, at some point?"

*

"What if reproduction is not just a reproduction of the Physical Body but also, the Emotional and Psychological bodies, flaws and all?"

*

"What if there is a limit to the amount of trauma that the Human Psycho-Biological Organism can store, before another safety mechanism is activated, that sees the flow of these traumatic experiences reverse and begin to be outwardly expressed?"

*

*“What happens when this reversal
takes place within an Individual?”*

*

*“Could there be a point in time,
within the span of Human existence,
that this begins to occur to a large
portion of the Human population?”*

*

“What if that time is now?”

*

*“Would it not take some of the most
Experienced, Robust and Resilient Souls
in the entire Universe to ride out
this unprecedented storm?”*

*

*“Can One even imagine what kind
of experience that would be?”*

*

*“Can One even imagine the Humanity that
would emerge from such an experience?”*

*

“Are You up for it?”

The Psychological/Emotional Intensity that is felt when dealing with the consequences of ancestrally repressed trauma, or legacy trauma, is the equivalent of a Division by Zero. Intense traumatic experiences essentially present a Division by Zero scenario.

If the Psycho-Biological Organism cannot process the situation being presented, it will compartmentalise it. Ideally, Awareness is brought to the matter and the Intensity allowed to peak, until the Inner Conflict resolves itself.

“But why would this Inner Conflict resolve itself?”

Because Nature cannot allow a stalemate, it cannot allow an impasse, so a viable Solution will be provided, so long as the Intensity is allowed to climax and is not hindered in any way.

The Solution may be a new Understanding, a new insight, a new door opening; releasing old habits, old fears, outdated situations. Any or all of these and more. But most importantly, it is a shift in Awareness, an adaptation to a higher Energy state.

Upon a successful resolution, a revitalisation and rejuvenation is felt, with some time for respite to rest and recuperate. But the process is not complete and it will continue in a very methodical manner, with the Intensity increasing as the capacity for greater Intensity improves.

Trying to subdue, dissipate or somehow eliminate the Intensity of unresolved Inner Conflict may result in violent or destructive behaviour to Oneself or Others. It is of great importance to bring and maintain Awareness in these situations to minimise destructive behaviour.

The early stages of this process can be most challenging, as One learns and develops the ability, capacity and Understanding of how to successfully attain a real resolution.

Self-Reflection is absolutely key here. Self-Reflection is exercising Awareness, encouraging it to penetrate deeper and deeper into a wholly Conscious state.

This is not a short-lived process.

A BEAUTIFUL ACHING

It will take a number of years to fully resolve itself. The Intensity levels will fluctuate in a wave like manner. It will seem as if each apparent disaster is simply followed by another, in a never-ending stream.

Hold Strong.

*The most Beautiful and
Meaningful outcomes,
Flower from the
Greatest Adversity.*

If One is to remember anything going into a time of such upheaval, then remember the statement that appears at the bottom of almost every verse, including this one.

*

BRING AWARENESS TO THE INNER CONFLICT...
FACE AND ALLOW THE INTENSITY...
A RESOLUTION WILL COME.



A BEAUTIFUL ACHING

DIVISION BY (0), A CONCEPTUAL EXERCISE

DISCLAIMER

When discussing the Transcendence of the Algorithm, any strict logical and rational approaches begin to break down very quickly, as these are the domain of the Algorithm. They are helpful in exploring within the Algorithm, but are next to useless beyond it. That is why this is referred to as a “*Conceptual Exercise*”, it is not a mathematical proof of anything.

FOUNDATION SUMMARY

The following is a summary of the information introduced in the verse, [Foundation Of Duality](#).

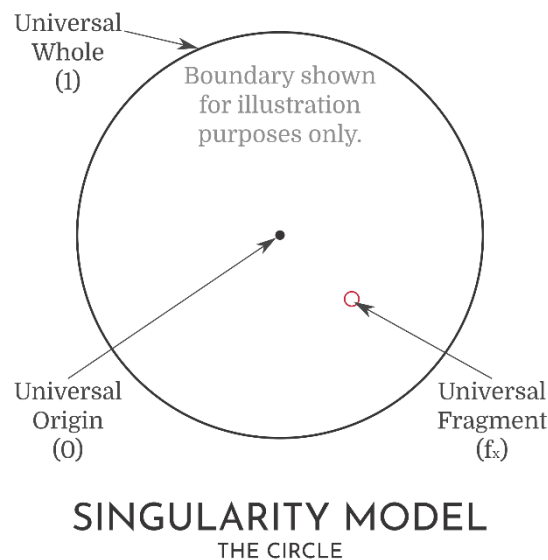

- (0) = Universal Origin, Zero Point, State of Nothingness, Singularity Source, Context.
- (1) = Universal Whole, Infinity, State of Everythingness, Singularity Universe, Subject.

- These are Qualitative aspects of Singularity; they represent the Everything and Nothing of Infinity. They do not represent numerical value; they are not Quantitative like the numbers 0 and 1.
- $(0) = (1) = \infty$, Since both are referencing Singularity. (∞ , Infinity Symbol)
- (f_x) = Universal Fragment, a division or boundary state within the Universe.
- $(f_1), (f_2), (f_3), \dots$ = A specific Universal Fragment.

DIVISION BY (0), A GENERAL APPROACH

Division by (0) in this case, means dividing some fragment of the Universe, (f_x) , by the Origin of the Universe, (0), which is also the Whole of the Universe, (1).

So, the Question that Division by (0) is effectively asking is,

*“How many times does the Universal Whole
fit within a particular Universal Fragment,
of which the particular Universal Fragment is a part?”*

Or put more simply,

*“How many times does the entire Universe
fit within a particular grain of sand,
of which the particular grain of sand is a part of?”*

Now, on the surface it may seem obvious that the Universe cannot fit within the grain of sand. Although it could be said that a fraction of the Universe can fit and that fraction is the grain of sand itself, but this is not the primary issue here.

The issue that arises comes from the fact that this is a Self-Referencing Question, because Singularity implies “*One and Only One*”, there is no Other, there is not multiple Universes or Infinities. So how can a fragment of the Absolute Whole, be divided by the Absolute Whole, of which it is a fragment?

Again, put simply, the individual grain of sand is a part of the Universe, so how can the Universe fit within the individual grain of sand, of which the individual grain of sand is a part of?

This leads to the Self-Referencing nature of the Question; it is Infinitely Self-Reflecting. Because if the grain of sand is being divided by the Universe at one level of reality then it is simultaneously being divided by the Universe at all levels of reality.

DIVISION BY (0), A SOMEWHAT TECHNICAL APPROACH

Division by Zero generally takes the form of,

$$\frac{x}{0}$$

This implies any number, x , divided by zero. All numbers exist within the numerical universe of Infinity, so are therefore divisions or fragments of Infinity.

However, in the case of this conceptual exercise, a Universal Fragment, (f_x) , is being divided by the Universal Origin, (0) , so rewriting the general Division by Zero equation using the above terminology we get,

$$\frac{(f_x)}{(0)} \text{ or } \frac{(f_x)}{(1)}$$

Which means that a fragment of the Universe is divided by the Origin of the Universe, which is also the Whole Universe, because both are the same thing.

Now, if we are talking about a specific fragment of the Universe, (f_1) , then the equation looks like,

$$\frac{(f_1)}{(0)} \text{ or } \frac{(f_1)}{(1)}$$

The problem that comes about for resolving this equation is that Universal Fragment 1, (f_1) , exists within the Universal Whole, (1) . So how then is Universal Fragment 1, (f_1) , able to be divided by the Universal Whole, (1) , of which it is a part?

A BEAUTIFUL ACHING

Since (f_1) is a unique individual Fragment within the Universal Whole, (1) , trying to divide it by the Universal Whole at one level of the equation means that it is concurrently being divided by the Universal Whole at the next level. Then, if it is being divided at the next level, it is also being divided at the level below that. In fact, it is being simultaneously divided at every level below and above the original level, wherever that is, all the way to Infinity.

$$\frac{(f_1)}{(1)} \leftarrow \frac{(f_1)}{(1)} \leftarrow \frac{(f_1)}{(1)} \dots$$

SIMULTANEOUS DIVISION INFINITELY SELF-REFLECTING

The Universal Whole, (1) , is referencing an aspect of itself in the form of Universal Fragment $1, (f_1)$. This is the Self-Referencing nature of the equation, it is Infinitely Self-Reflecting, above and below.

This is why Algorithms cannot cope with this type of equation, because they always tend toward Infinity.

*

BRING AWARENESS TO THE INNER CONFLICT...,
FACE AND ALLOW THE INTENSITY...,
A RESOLUTION WILL COME.



A BEAUTIFUL ACHING

A DISCUSSION ABOUT MODELS

All models are essentially an analogy. They represent the actual item or subject of that analogy in a form that is intended to define and describe its nature, not to replicate its reality.

They are a simplified conceptual device for describing isolated aspects of reality. They can never represent the 100% True Nature of a situation, because the True Nature of a situation is tied into the complex web of all of Creation and no model can replicate all of Creation.

By isolating an aspect of Creation, many of the interconnections and their influences are missed. But the isolation is necessary, because otherwise the underlying complexity would be too overwhelming to be able to develop a meaningful Understanding from.

As is often the case, some models are more valuable than others and their value is determined by how well they describe and represent the system that is being explored.

The best models will be based on a deep foundational Understanding, upon which further complexity of the system can then be built.

Whereas, models that are built on poor foundations will not be able to support any complexity built on top of them. They will require constant reinforcing and bolstering, which results in them being turned into a contorted mess just to be able to support a simple facade of understanding.

*

BRING AWARENESS TO THE INNER CONFLICT...
FACE AND ALLOW THE INTENSITY...
A RESOLUTION WILL COME.

A BEAUTIFUL ACHING



A BEAUTIFUL ACHING

THE DIRECTION OF RESOLVING CONFLICT

The direction of Conflict resolution is incredibly important in the process of establishing Clarity and exercising Awareness toward full Conscious expression.

If One's sole objective is to either avoid Conflict or only resolve Outer Conflicts, then a never-ending quest is undertaken, as Conflicts are expressed from an Inner source and projected Outward, forever Diverging.

But if the primary direction of resolution is turned Inward, then the Conflicts are Converging and an eventual full resolution is possible.

The associated image of the Human Being Model will be used to demonstrate this point.

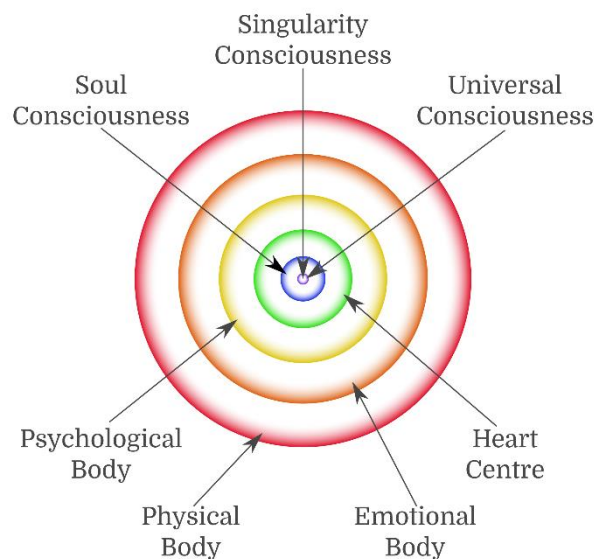

HUMAN BEING MODEL
CONCENTRIC RINGS

OUTER CONFLICT

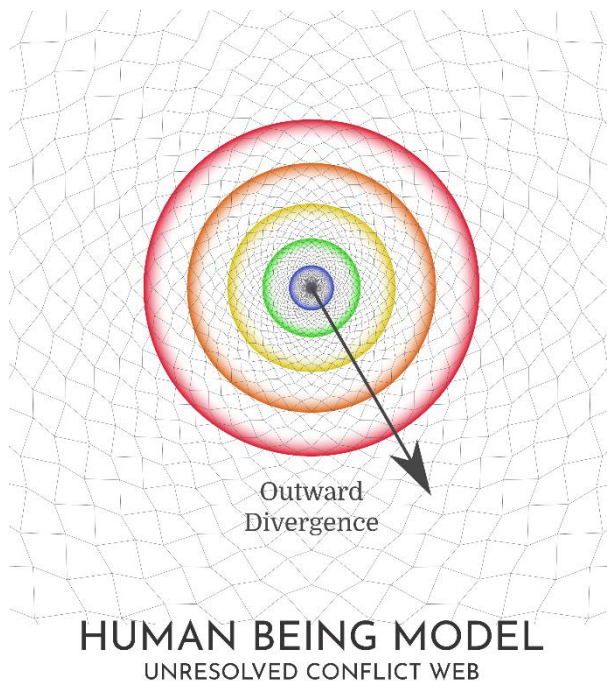

From the Unresolved Conflicts image shown opposite, the web type overlay represents the labyrinth of interconnected Conflicts projecting from near the Source.

If One is to fixate on only resolving Outer Conflicts, then it can be seen that there is never an end to the Conflicts that require resolution, because the Conflicts are in a Diverging trajectory.

Meaning, that the further One moves away from the source of the Conflicts, the

more Conflicts there are and the more that will be created.

INNER CONFLICT

However, if the primary direction of Conflict resolution is turned Inward, then the Conflict paths are Convergent and ultimately lead to the state of Singularity upon resolution.

Attaining this state does not mean that all Conflicts everywhere are resolved forever. It simply means that the Conflicts are now observed from the perspective of Singularity, rather than the perspective of One whose Awareness is lost in the endless maze of never-ending Conflicts.

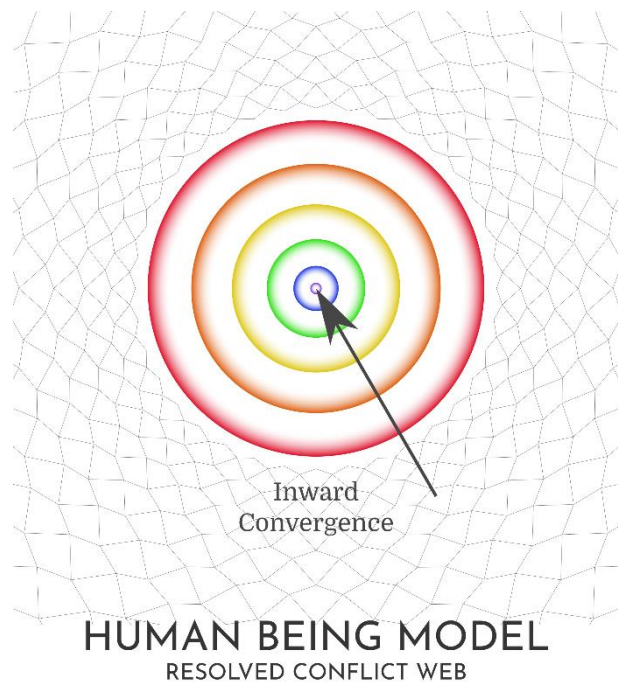

This is a condition which is detached from the ever-present, Conflicting Nature of the Universe, by virtue of the Clarity that is offered from this vantage point.

*One's True Self,
One's True Expression,
is buried under a Mountain
of Inner Conflict.*

Awareness is always Outward facing, but the movement of Awareness is ideally Inward. One way to express what is meant by this statement is with the following example.

If One were to stand closely facing a wall within a room, then all that could be seen in this circumstance, would be the wall directly in front. This is assuming that One is not able to turn their head nor body in any way.

One is unlikely to be Aware of what is behind them and the only way to become Aware would be to begin moving backward. So that what was behind, then appears in front, purely by the change in perspective from the backward movement.

This is how Awareness moves deeper within Consciousness. Awareness itself cannot turn around to see what is behind it, but it can progress deeper. Its viewpoint can transition, so what was behind, then appears in front and subsequently, new Understanding is gained from this shift in Context.

To further demonstrate this concept, consider the scenario where One is lying face up on the surface of a deep body of water. Perception of what may be below is difficult from such a position. But as One sinks lower and lower into this body of water, what was below would soon be above, with Awareness deepening all the way to the bottom.

To add a little more complexity to this situation, it is not Awareness moving under its own volition that creates the movement deeper toward the Source, but the resolution of Inner Conflict behind it that leaves a vacuum and that vacuum draws Awareness deeper.

A BEAUTIFUL ACHING

It is the process of Psychological/Emotional compartmentalisation/repression that pushes Awareness further and further out toward the surface of Human experience. So once it reaches the boundary limit and the underlying pressures force a change, the only options available would be to attempt to destroy Awareness itself, or begin the long and arduous journey back to the Source.

With Awareness at such shallow levels, the underlying [Energy Node Points](#) and associated Bodies atrophy, due to the lack of Energy flow through them. This then severely diminishes signalling to and from the Source, thus seriously inhibiting Human function and life experience.

*Often, the barrier to resolving Conflict
is not the Answers One seeks,
but the Questions One asks.*

*

BRING AWARENESS TO THE INNER CONFLICT...
FACE AND ALLOW THE INTENSITY...
A RESOLUTION WILL COME.

REFERENCES

[Energy Node Points](#) – References the verse, [Anatomy Of The Human Being](#).



A BEAUTIFUL ACHING

THE HUMAN CONSCIOUSNESS MODEL

The purpose of this model is to illustrate the associations and interactions between some of the more prominent aspects that make up Human Consciousness. It has been developed to fit around a Spinning Top figure, which provides the most suitable form and symmetry to define and describe these relationships.

In terms of value, this model simply offers a visual representation of the processes that exist in developing deeper levels of Awareness. It makes no claims other than that and it should not be considered of any greater value than that.

For a brief discussion on the usefulness and validity of models please refer to the verse, [A Discussion About Models](#).

MODEL COMPOSITION

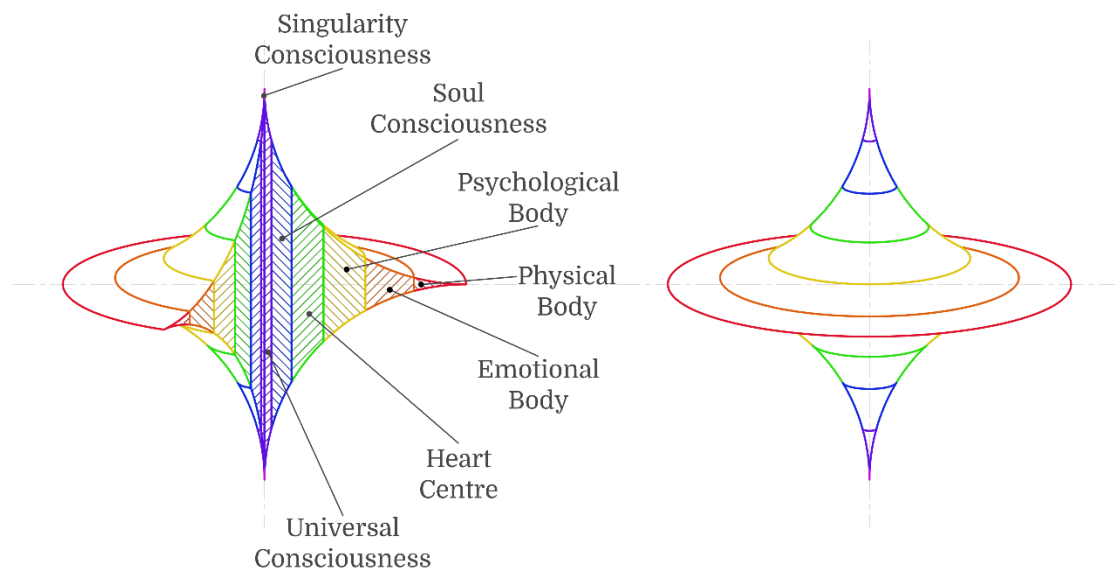

HUMAN CONSCIOUSNESS MODEL
SPINNING TOP

A BEAUTIFUL ACHING

First off, the Spinning Top Model is made up of layers which correspond to the anatomic layers of the Human Being, as described in the verse, [Anatomy Of The Human Being](#).

The associated image above shows the structure and arrangement of these layers, with the Physical Body being represented by the Outer most ring and the Vertical axis representing Singularity. While the other Bodies and Consciousness layers are proportionately arranged in between.

The fully formed model as presented in the above image describes an Individual whose Awareness has reach the state of Singularity, as the Spinning Top figure is shown to be complete and balanced.

Whereas, an Awareness level that has yet to reach this point, will be represented by an incomplete disk that is disconnected from the central axis.

ASPECTS OF THE MODEL

A list of key aspects of Human Consciousness are presented below, with their depictions on the Spinning Top Model being shown in the corresponding image.

- **Awareness** – Outward looking Inner face. It can also be considered a permeable membrane.
- **Understanding** – Both side faces of the Knowing volume. This references the capacity to Understand Truth, it does not mean “*understanding everything*”. Dualistic in Nature.
- **Clarity** – The Angular Sweep of the two faces of Understanding about the Singularity axis.
- **Knowing** – The volume created by Awareness and Understanding. This references the capacity to Know Truth, it does not mean “*knowing everything*”.
- **Singularity** – Vertical axis. Singularity is actually just the Origin Point, but as it expresses, the Dualistic framework is formed. Upward from the Horizontal plane is Positive. Downward from the Horizontal plane is Negative.

- **Separation from Singularity** – Horizontal axis. This is the separation of Awareness from Singularity.
- **Space/Time Arena** – Horizontal plane.
- **Sub-Awareness** – Phantom Zone or Shadow Self. Generally referred to as the “*sub-conscious*”, but this term is inaccurate.
- **Energy Flow** – Corresponds to the Vertical height of the Knowing volume. Dualistic in Nature, symmetrical about the Horizontal mid-plane.

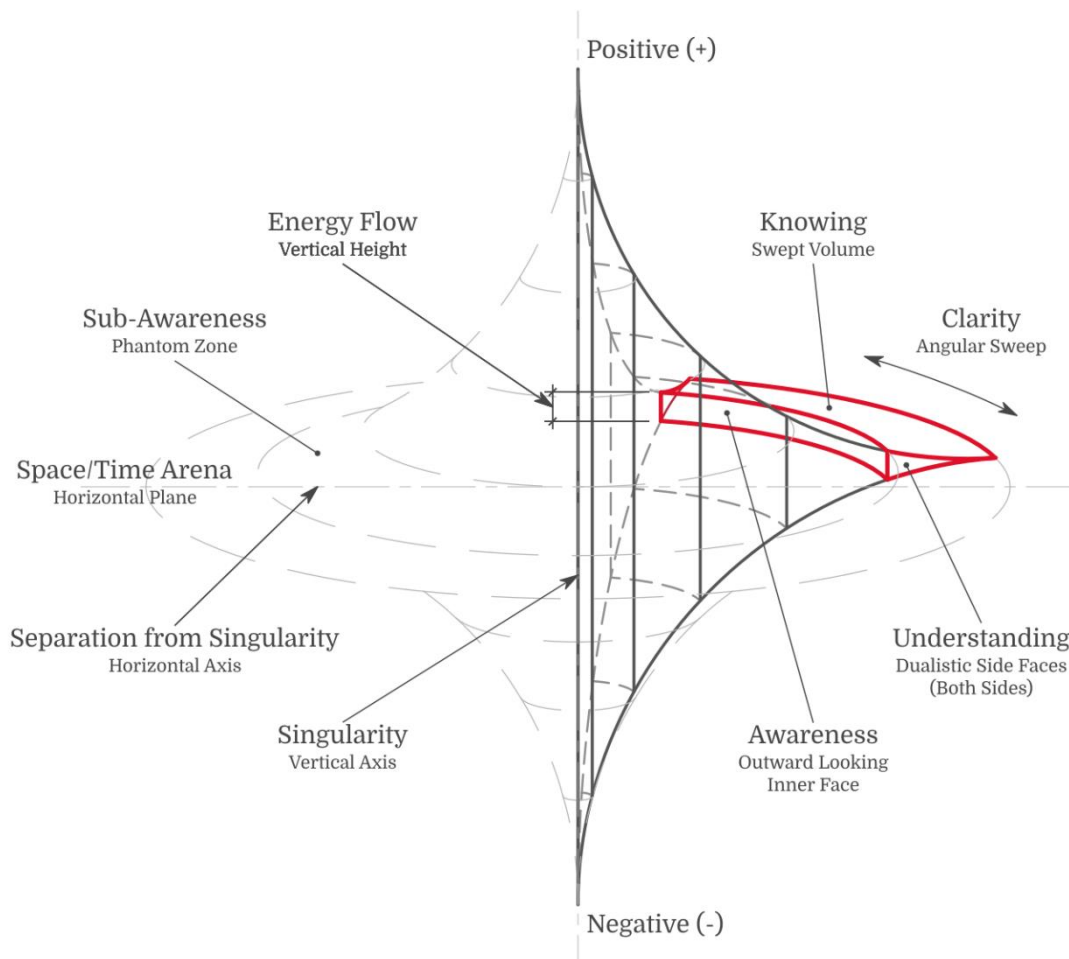

HUMAN CONSCIOUSNESS MODEL
DEFINITIONS & DESCRIPTIONS

HOW THE MODEL WORKS

1. The Awareness plane or membrane is somewhat permeable, so the Inner Conflicts that make up Sub-Awareness or the Phantom Zone will infuse through into the Awareness membrane. Especially as more and more pressure builds within the Sub-Awareness volume.
2. As these Inner Conflicts are presented to Awareness via this permeation process and are dealt with in a manner that resolves those Conflicts, see the verse [The Creative Solution Explored](#), the resolutions that manifest themselves culminate in greater Understanding. This Understanding then transitions into and increases the Knowing volume. In doing so, the Awareness face moves deeper, filling the void left behind it by the resolved Conflict. While the Understanding faces symmetrically sweep further around the Singularity axis, thus increasing Clarity.
3. These changes cause both the Awareness face and the Understanding faces to increase in surface area, at least at the initial levels of the model. The Awareness face begins to decrease in surface area as that face progresses through the steeper portions of the Spinning Top form. This demonstrates the initial broadening of Awareness at the early stages, followed by a greater potency to Awareness as it approaches Singularity and becomes anchored in the moment.
4. The rise in Vertical height of the Knowing volume equates to an increase in Energy Flow, with the Vertical change being symmetrical in both directions about the mid-plane. This symmetrical growth is similar to the way a tree needs to develop deep roots to be able to grow tall.
5. These transitions all move into the space referred to as the Phantom Zone or the Sub-Awareness.
6. If this process is allowed to continue, the Awareness face will journey through all the Bodies and states of Consciousness and culminate in a merger with the Singularity axis.

MODEL TRANSITIONS

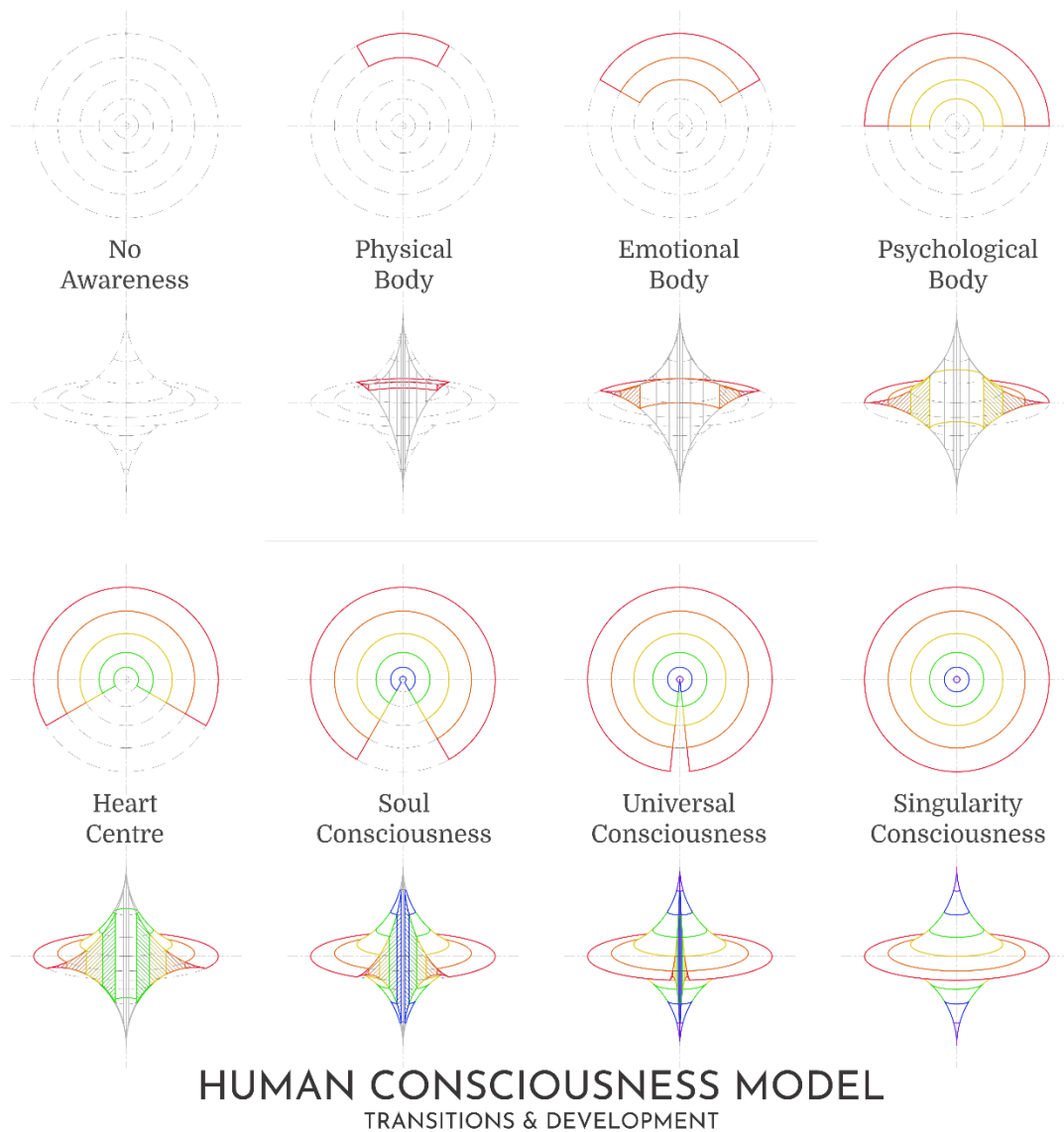

Progression and development of the Spinning Top Model, as Awareness transitions toward Singularity, is laid out in the above image and a description for this process is as follows,

1. **No Awareness** – At the absolute edge of the Outer ring is the state of No Awareness. Here there is no Awareness, no Understanding, no Clarity, no Knowing and there is no Energy Flow. Here, there is Nothing.
2. **Physical Body** – Expression of the Physical Body gives birth to some level of Awareness, Understanding, Clarity, Knowing and Energy Flow. Energy Flow

increases moderately for a given movement of Awareness toward the centre, as demonstrated by the shallow slope of the Spinning Top form in this region.

3. **Emotional Body** – As the Awareness face moves deeper there is progression into the Emotional Body, this comes with a greater spread in Understanding and Clarity, thus an increase in Knowing.
4. **Psychological Body** – At the Psychological Body stage there is a further increase in all the correlating aspects, as Awareness proceeds closer to Singularity.
5. **Heart Centre** – This area sees a significant increase in Energy Flow for a given transition of Awareness toward the centre. The experience of greater Intensity when resistance from Conflicts eventuates, is the by-product.
6. **Soul Consciousness** – The steepness and height of the Spinning Top form in this vicinity indicates the drastic increase in Energy Flow for a relatively small shift in Awareness. As a result, very high levels of Intensity are experienced when engaging Inner Conflicts through this area.
7. **Universal Consciousness** – Break through. At this point, Energy Flow levels are high but very little to no resistance from Inner Conflicts is encountered, as complete resolution is near.
8. **Singularity** – Wholeness has been achieved and every aspect of Consciousness asymptotes toward Infinity. With the limiting factor being the Psycho-Biological Organism itself and its capacity to sustain.

An important point to note here is that as Awareness transitions through all the Bodies and states of Consciousness, each of these expressions are not full developed until Awareness completes its progress to Singularity itself.

Transitions of Awareness from a Body or state of Consciousness occur when the preceding levels develop to the point of being able to support the next level above. The foundation simply needs to be sufficiently suitable; a base threshold need only be met.

To emphasise again, full expression and development of all the Bodies and states of Consciousness is not experienced until Singularity is reached.

*

BRING AWARENESS TO THE INNER CONFLICT...
FACE AND ALLOW THE INTENSITY...
A RESOLUTION WILL COME.



A BEAUTIFUL ACHING

PERSPECTIVES ON TRUTH

The verse, [Calibrating For Truth](#), discusses the notion of “*My Truth*” and “*Your Truth*” as being misguided and delusional and although this point still stands, there are different perspectives to Truth that are valid.

These perspectives, at first glance, may seem unrelated and even quite contradictory, but upon further and deeper investigation, an underlying commonality may be found.

If One is to consider the situation where two Individuals are placed at two different locations around a large architectural structure, such as a building, then asked to draw what they see before them. It is very likely that both Individuals would draw a very different image from one another, even if it is assumed that what they draw is an accurate representation of what they see.

They may then convene to compare what they have drawn and be surprised at how different each image is, given that they are made aware that both images represent the same structure or are parts of the same structure.

It is also possible that neither Understand what they themselves have drawn until they are free to explore the entire structure, so as to observe the proper Context, of not only their own image, but also the image drawn by the Other.

Although each of their perspectives is unique at the Time and Space that the images are drawn, the actual structure they draw is Objective and both perspectives are shown to be valid once the overall Context of the Objective structure is Understood.

*

BRING AWARENESS TO THE INNER CONFLICT...

FACE AND ALLOW THE INTENSITY...

A RESOLUTION WILL COME.

A BEAUTIFUL ACHING



A BEAUTIFUL ACHING

SPECTRUM OF AWARENESS

The term “*Awareness*” has been used extensively in previous verses, but what is meant by this and how does it differ from “*Consciousness*”?

Well, Awareness in this physical reality spans the spectrum from Death to full Consciousness. With Death implying no Awareness, while full Consciousness indicates an unobstructed connection to Singularity, because full Consciousness is Singularity.

It is important to note that full Consciousness in this context, refers to the Human Psycho-Biological Organism’s maximum Consciousness capacity.

The Physical Body being awake and not sleeping does not equate to a fully Conscious state.

Also, Consciousness is not the thoughts that One has, Consciousness is the Observer of those thoughts.

If Consciousness is equated to the Source of all water everywhere, then the spectrum of Awareness is the drop, the puddle, the pond, the lake, the sea, the ocean. These are all fractal states of water and similarly of Awareness.

Each drop of water, is water, it is complete, there is nothing missing. Substantively there is no difference between one drop of water or an entire ocean of water.

Awareness stuck within the Algorithm only Understands what that particular level of the Algorithm is capable of allowing it to Understand. Its range and capacity is limited to the drop, the puddle, the pond, the lake, the sea, the ocean.

Awareness that has Ascended to the level of Consciousness, Knows Infinity. It Knows the Source from which all water has come. Its range and capacity is all water, everywhere.

A BEAUTIFUL ACHING

Low level Awareness is the equivalent of standing on a shoreline and getting One's feet wet, then becoming hysterical over the "*Intensity*" of the experience.

High level Awareness is swimming out into the deepest part of the ocean, during the most extreme and vicious storm, whilst being calm and at ease in this exceedingly difficult situation.

Consciousness however, is not only the swimmer in this plight, but it is also the ocean and storm in which all this takes place.

*Consciousness is the Silence
in which the Music is played.*

*It is the Stillness,
from which the Breath is drawn.*

With Consciousness, no Boundaries exist, no Questions are possible, all those have been left behind and only Silence, Stillness remain.

Awareness is the personal perspective, a fractal aspect of Consciousness. Just like Light is Light, whether the Light is coming from a candle or the Sun. It is only a matter of scale and Intensity.

Additionally, the idea of a "*sub-conscious*" is inaccurate, because there is no "*sub*" to Consciousness. Meaning that there is nothing that is beyond or below Consciousness.

There is however "*sub-Awareness*", a state in which One is unaware of Self and the level of unawareness is dependent on One's capacity to delve deep into the unknown of the Self. Or put another way, One's capacity to Self-Reflect.

*Consciousness is not an Expression,
it is the Source of all Expression.*

*Consciousness is not an Absorption,
it is the Void that welcomes all Responses.*

THE DEPTH OF SUBSTANCE

When looking at the surface of a puddle
and comparing it to the
surface of a small patch of ocean,
One may get the impression
that they are both, just water.

But they most definitely do not
equate to being the same thing.

In other words,

*Mimicking qualities superficially,
does not Manifest Substance.*

*

BRING AWARENESS TO THE INNER CONFLICT...,
FACE AND ALLOW THE INTENSITY...,
A RESOLUTION WILL COME.

A BEAUTIFUL ACHING



A BEAUTIFUL ACHING



MANIPULATE THE ALGORITHM?

*“Can the Algorithm be manipulated
with Conscious intent?”*

The above Question is one that may surface if the previous verses have been sufficiently understood and considering that the Algorithm is a product of Consciousness and the Human Being has the potential to attain a fully Conscious state, it is valid.

But then, the follow up Question that should be asked is,

“Why?”

Why would One wish to manipulate the Algorithm, if One has attained a fully Conscious state?

The desire to manipulate the Algorithm implies a fear of the Algorithm, or at least a fear of certain outcomes of the Algorithm.

However, all fear is to be drop before One can attain a fully Consciousness state, so the Question is essentially pointless.

Consciousness does not fear the Algorithm, nor any outcome of the Algorithm. The Algorithm is free to do what the Algorithm has been Created to do.

Consciousness simply explores the Infinite possibilities of the Algorithm, discovering the many Extraordinary expressions that the Algorithm manifests.

It is ego that is afraid of the Natural Algorithm and its outcomes.

It is ego that desires to control and manipulate the Algorithm because of its fears, doubts and insecurities.

Ego is the false Self, the illusion of Self.

A BEAUTIFUL ACHING

Ego is the outcome of chronic legacy trauma. Refer to the verse, [Crash The Algorithm, Part Two](#).

Essentially, ego is fear.

*Intelligence built on a solid foundation of Wisdom,
can achieve the Extraordinary.*

*Intelligence absent of any Wisdom,
is simply cunning, deceitful and manipulative.*

If One still feels unsatisfied with this particular response, then the only other option available is, to come and find out.

The invitation has and always will be there.

*

BRING AWARENESS TO THE INNER CONFLICT...
FACE AND ALLOW THE INTENSITY...
A RESOLUTION WILL COME.



A BEAUTIFUL ACHING

THE ANTI-AUTHORITARIAN PARTY

(Satire)

*We interrupt the regular scheduled programming
to bring you this political message.*

The Anti-Authoritarian Party (A.A.P.) of *<insert country name here>* exists for the sole purpose of making ourselves extinct, with the intent of never being resurrected again. Ever!

The way we would like to achieve this goal is by gaining public support, through the ballot box, to deconstruct the authoritarian systems that have infested our great country like a cancer and disguised themselves as Freedom and Liberty, by incessantly using words like “*Safety*”, “*Security*” and “*Democracy*” whenever describing these same oppressive policies and systems.

We see that the time of centralized authoritarian political power structures is fast coming to an end and that ending can either be chaotic and destructive to Humanity or it can be achieved in a controlled, peaceful and organised manner.

Stupidly, we prefer the controlled, peaceful and organised option.

We wish to dismantle the functions and services that authoritarian political power structures have monopolised for themselves and either abolish them altogether, or pass them on to private individuals and organisations, so they may offer them to the public in the spirit of healthy economic co-operation and competition.

So, what are we up against in our vigilant quest?

INTRODUCING THE COMMI-FASCIST

We would now like to take this opportunity to introduce people to an animal that, over many centuries, has been the source of great turmoil in this world. While at the same time deflecting responsibility for its countless crimes and failures.

We would like to introduce, The Commi-Fascist.

This strange beast may be unfamiliar to most by this particular name, as this creature is extremely schizophrenic by nature and likes to masquerade as a “*Communist*” or a “*Fascist*” as if they were two completely separate and different animals. But really, they’re not.

The Commi-Fascist likes to pretend that it is the opposite of what it actually is and thus aggressively and sometimes violently, attacks those that most resemble it or try to expose it. So it is best for the untrained not to hold a mirror up to these creatures, as this infuriates them no end. These are such hideous beasts that not even they can stand the sight of their own reflection, without having a violent episode.

The Commi-Fascist’s scientific classification is, *Politicus Hypocriticus*.

Like a chameleon, changing its name to suit its political surroundings is an adaptive measure and the Commi-Fascist has gone by many aliases over the course of Human history. But what it cannot change and what the Commi-Fascist can always reliably be identified by, is its base authoritarian nature.

Over time, the Commi-Fascist has developed a sophisticated hunting style, in which it no longer presents itself in its true form of horns and a pitch-folk. Instead, it has now refined a technique that has it stealthily approach its timid prey, while creating a pretence of caring and only wishing to help and serve its bedazzled victim. But this ruse is maintained only long enough to subdue its target into a sense of false security, until it finally exposes itself with its vicious nature. However, by then, it is often too late to save the helpless and thoroughly dependent vassal.

The Commi-Fascist is a binary pack animal, which means together they play a “*Good Cop*”, “*Bad Cop*” routine to set the trap for their next, unsuspecting conquest.

One tried and tested game, that delivers a very high success rate, is the *“Political Power Spectrum”*. This is a devious creation which has one end occupied by the *“Communists”* and the other end by the *“Fascists”*. Then once in position, they proceed to squabble amongst themselves, attempting to herd everyone else into the middle of their quagmire.

But what is not immediately obvious, is that there really is no *“middle”* in this game and the reason for that, is the fact that these are essentially both the same extremes. There is no real difference between the two of them, even though the game is played as if there were.

Both are authoritarian by nature, so taking a middle position means choosing half of one authoritarian system and half of the other authoritarian system, which in total, still amounts to one full authoritarian system.

And that is their trick!

Even if a different position on this spectrum is taken, the total is still, one full authoritarian system. Whether that is a 25/75 percent mix or a 75/25 percent mix, the total is still, one full authoritarian system.

It’s all in the math, people.

It’s like having a colour spectrum that is book-ended with two slightly different shades of poo brown. Well, with such a system, every position within that spectrum is going to be a shade of poo brown. Is it not?

This means that you’re going to get shafted, while swimming in poo, no matter where you choose to pitch your tent. There is virtually no escaping this playing arena, once it has been entered.

So, here’s a tip for young players...

Don’t play this game, it’s a trap!

JOIN OUR COMMON CAUSE

Now that we have introduced ourselves and what we are up against, we hope that you are encouraged to join us in our valiant endeavours, so we may all see a truly strong, free and prosperous Humanity in our lifetime.

Finally, please take a moment to read what some of our members have to say.

*Authoritarians often use victim-hood status
as a justification for the oppression of Others.*

*One cannot have Power over One's own life,
if One is not Responsible for One's own life.*

Voting for "Leaders", is Psychological Acquiescence.

*It is abdicating responsibility for One's own life,
while creating the illusion of power.*

*Authoritarians will often feign
concern and caring for others,
when their agenda requires.*

*But it's surprising the speed
at which all that disappears,
when the next war needs to be sold.*

*What right does another person have,
to use a third party, such as government,
to enforce their own values,
beliefs and opinions onto you?*

Voting in a "democracy", is doing just that.

*If Authoritarians know that there are certain
situations where Authoritarian action
is acceptable to those they wish to subjugate;*

*What then is to stop them from
actually creating those situations?*

*When assessing the actions of government,
three things should be considered,*

- 1. Incompetence is a given.*
- 2. Corruption is highly likely.*
- 3. Maliciousness must always
be suspected.*

*Because this is the nature of those
that are attracted to Authoritarian positions.*

*The government is good at one thing.
It knows how to break your legs and then
hand you a crutch and say,*

*“See, if it weren’t for the government,
you wouldn’t be able to walk.”*

Harry Browne

*When governments and corporations
offer products and services for “free”,
it is equivalent to the farmer
feeding his farm animals, for “free”.*

Government's farming operations provide it with,

.

Multiple extortion-based revenue streams.

A reliable source of cannon fodder.

*All the useful idiots it could ever need
to attack and suppress dissent.*

*And a herd that believes Government
serves their interests.*

.

What a magnificent gift.

*Government is a criminal
organisation and operation,
that has managed to legalise itself.*

.

*Government does not exist
for your benefit.*

*Governments are nothing more
than Gatekeepers
for Special Interest Groups.*

*Politicians will identify the
things You care for and love,
then concoct ways to
use them against You.*

*All for the purpose
of gaining more Power
and Control over You.*

*Political Promises are paid for
from your wallet at exorbitant cost.*

Beware of Politicians Bearing Gifts.

*Could you be paying for
your or your children's
enslavement or eradication?*

*A Socialist is nothing more
than a Commi-Fascist Wolf
in Sheep's clothing.*

*Civilised societies
do not require governments.*

*Only uncivilised societies
require governments.*

Authorised by

The Anti-Authoritarian Party of <insert country name here>

Written and produced by

[A Beautiful Aching](#), for Humanity's Anti-Authoritarian Party



A BEAUTIFUL ACHING

T THE HEART CENTRE

This next series of verses is a continuation of the [Anatomy Of The Human Being](#) verses and picks up from where the [Human Psycho-Biological Organism](#) series left off, which was the verse [Characteristics Of The Three Bodies](#).

The Heart Centre is unique in the structural makeup of the Human Being, in that it is not one of the Bodies or states of Consciousness, but instead is the interface between the Human Psycho-Biological Organism and Mind/Spirit.

The Heart Centre is the fulcrum, the balance point, between the aspects of Consciousness and the material Bodies through which life is experienced.

Awareness transitions this region relatively quickly, due to the fact that it is essentially a junction point.

Some of the features that characterise experiences beyond this level are,

- There is no specific gender expression at or above/deeper than this level. However, this does not mean that gender is not expressed through the Bodies in the material world, in fact they are even more defined and refined.
- Duality, in general, becomes less and less polarised the higher or deeper Awareness penetrates.
- The Intensity of Psychological and Emotional experiences ramp up.

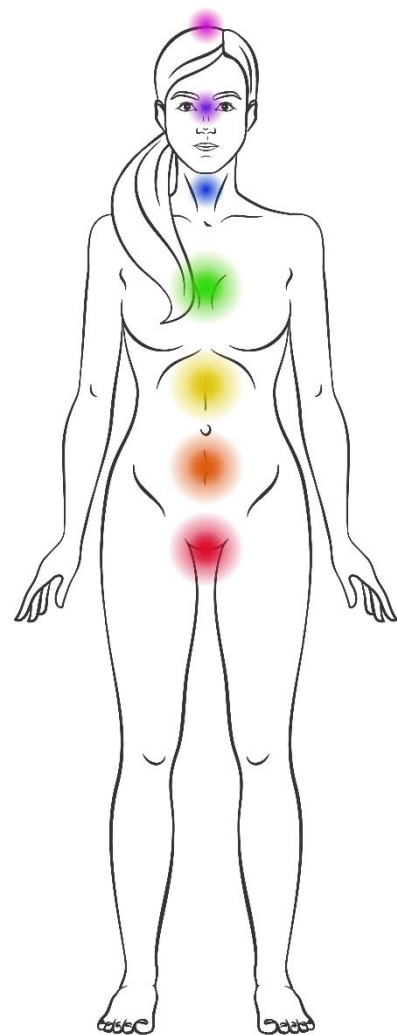

*Upon Awareness's path toward Singularity,
One cannot Imagine what will be Discover.*

*Because what will be Discover,
is far beyond Imagination.*

*

BRING AWARENESS TO THE INNER CONFLICT...
FACE AND ALLOW THE INTENSITY...
A RESOLUTION WILL COME.



A BEAUTIFUL ACHING

MIND/SPIRIT

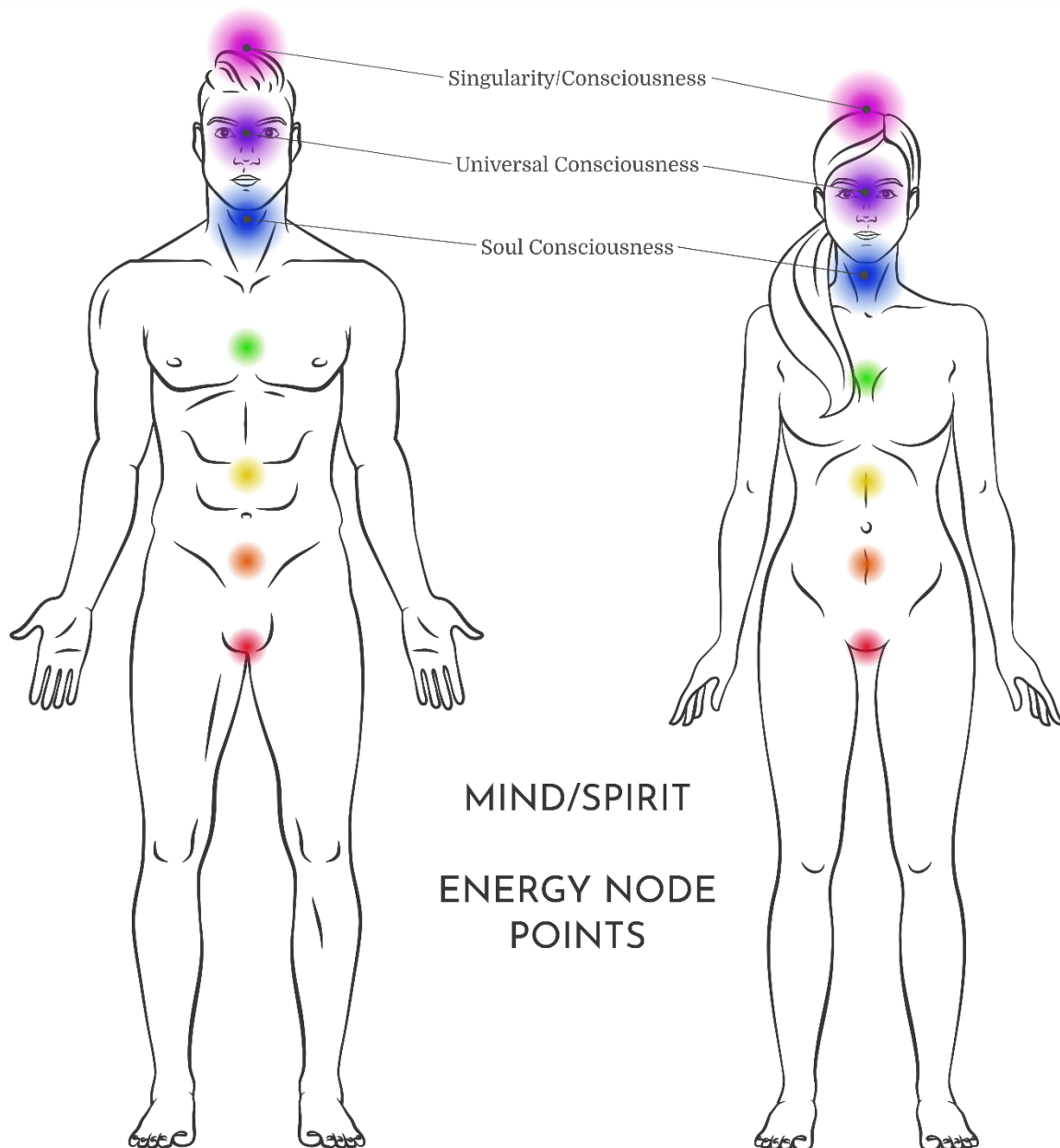

Mind/Spirit is the more refined, less dense, high frequency Consciousness aspect of the Human Being, although defining this in a tangible way that is meaningful and satisfying is difficult.

Definitions of material items and concepts are less problematic, as One can associate and correlate these descriptions through both the Physical and Emotional senses.

A BEAUTIFUL ACHING

Definitions involving areas and functions of Consciousness are tricky, since most have yet to develop the level of Awareness and internal sensory infrastructure to be able to recognise what is being referred to in these descriptions, but attempts will be made nonetheless.

Mind/Spirit is made up of,

- Soul Consciousness.
- Universal/Creation Consciousness.
- Source/Singularity/Consciousness.

Transitions through the gateways of these states of Consciousness are met with a very strong sensation, with others having previously referred to this sensation as “*Bliss*”. Bliss is an ecstasy surge that is so potent it reaches the point of being uncomfortable, which may seem an odd thing to state. A crude similarity can be made with being tickled, which in itself is not painful, but it can be uncomfortable.

These ecstasy surges are experienced as Awareness transitions into each of the three Consciousness states of Mind/Spirit, although there is a relatively mild teaser of this within the Heart Centre.

BLISSFUL IGNORANCE

Ignorance is not Bliss.

Ignorance creates a
shallow Illusion of Bliss.

Be assured, that all Illusion,
along with the Ignorance,
will eventually be shattered.

So, the real challenge comes,
in finding the Strength and Courage
to Rise from the Ruin.

GATEWAY TO THE TRUE INDIVIDUAL

I will give my Life for you.

But I will not live my Life for you.

Osho

Those that make it to this point must have a strong sense of Individuality. Hive or herd identity is a state that is more associated with the Human Psycho-Biological Organism, as there is no real sense of Self within that space.

Sparks of Individuality can exist in the shallower expressions, which may lead to deeper discoveries, but for the most part, it takes an intense and sustained Inner upheaval to provide the necessary catalyst for truly deep exploration.

It is also important to remember that Singularity is “*One and Only One*”. A fractured identity needs to be resolved if One is to come even close to this state of Being and a hive or herd identity, in a Human Being, is a fractured identity.

Another aspect that should be noted is that those that lust to rule the herd and those attention seekers within the herd, possess some of the most elevated levels of herd identity of all. Even though, they may present themselves as the strongest, or the smartest, or the most capable.

What they are actually hiding is the fact that they themselves are so insecure in their own Self, they are so insecure about their own Individuality, that they desperately need the reassurance of the herd and they desperately need to control the herd to pander to

A BEAUTIFUL ACHING

those insecurities. This level of desperation requires the comfort and obedience of the herd at all times.

These rulers and attention seekers are some of the most insecure and neurotic Individuals of the herd. This then is what makes them some of the most dangerous as well, given that they may go to great lengths to maintain their elevated status within the herd.

A strong Individual requires none of this attention.

A strong Individual is comfortable within themselves, regardless of how the herd thinks or feels about them.

A strong Individual does not need approval from the herd to validate their existence.

A strong Individual wishes no harm or ill will toward the herd or any individual member of the herd.

A strong Individual will go about their life, learning and adapting as best they can to the situations that Life creates for them, with little fuss or fanfare.

A strong Individual is not an isolationist! Although they have no issue functioning on their own, if required.

A strong Individual Understands that to live an efficient and prosperous life requires the co-operation of others, preferably other strong Individuals, but any Individual that is prepared to engage in a willing and co-operative exchange is a benefit to all parties.

A strong Individual does their best to not be a burden on others.

A society of strong Individuals engaging freely, respectfully and peacefully, is the base foundation of a strong and solid society.

A society of weak and feeble sheep, destroys itself in only a few short generations.

This is because pandering to the whims of a relatively small number of insanely insecure, neurotic, status seekers is a tremendous drain and burden on the rest.

Additionally, with the other herd members lacking the fortitude to say **NO!** to these insatiable lunatics, destruction is the only possible outcome.

However, being a black sheep is not the same as being an Individual either. Engaging in activities and holding opinions that are always counter to that of the herd, is still being controlled by the herd. No matter what the herd thinks or does, the black sheep will think and do the opposite. So it really is just a sheep in denial.

Herd identity is also more commonly known as, "*The Ego*".

Feelings of Powerlessness stem from the ego, because ego is what desires to control and manipulate all it can. Mainly as a way to avoid exploring, engaging and resolving fears and insecurities.

But a truly Powerful Individual, does not feel the need to unduly control or manipulate anything.

Because a truly Powerful Individual, is strong enough to be what they need to be and do what they need to do.

Thus, from that, they let the cards fall where they may.

*Ego is a compensation mechanism,
which attempts to accommodate
for a fragile psyche.*

*

BRING AWARENESS TO THE INNER CONFLICT...
FACE AND ALLOW THE INTENSITY...
A RESOLUTION WILL COME.

A BEAUTIFUL ACHING



A BEAUTIFUL ACHING

S SOUL CONSCIOUSNESS

DISCLAIMER

The information provided in this verse is presented, as is. No proof is given and no logic or reasoning is laid out as validation; primarily because, currently, this is not possible.

One may come to this same perspective and Understanding, or variations of, through the course of their own pursuits, but no one can be made to see, what their eyes are not ready to see.

The best that can be achieved here is that when taken within the full context of the information provided in these writings, it can be seen that it fits with the greater, overall picture that is being painted.

This disclaimer may apply to any number of other verses, but it is particularly applicable here.

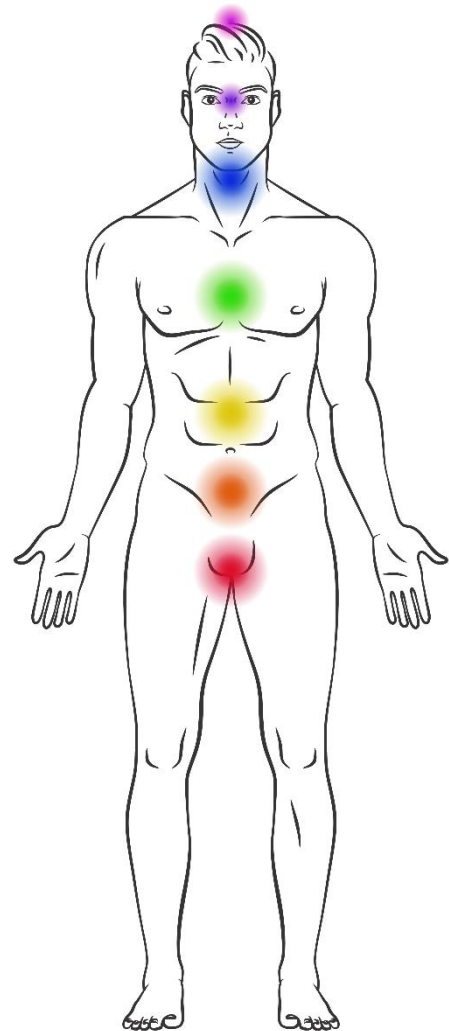

THE SOUL, A VERY GENERAL OVERVIEW

The Individual Soul is a fragment of Singularity and like all fragments it is subject to the constantly shifting boundaries within Singularity. This means that it is not Infinite, it is not Eternal, but rather it comes into being, serves its time and purpose, then dissolves back into the Silent Stillness of the Void. Enriching the Whole with all that it has gained through its existence and experiences.

A BEAUTIFUL ACHING

As with all things within Singularity, a Soul is essentially an Algorithm, with its birth and initial development occurring around and on a planetary body. Generally, a planetary body that has the capacity to sustain at least one Sentient life form.

This development is achieved by means of Incarnation through those Sentient life forms and also in Non-Incarnate states around the planetary body itself. Both Incarnate and Non-Incarnate Souls provide a structural and stabilising influence to the energetic forms that support all life on the particular planet in question.

There is also a population ratio that is maintained between Incarnate and Non-Incarnate Souls and the exact proportion is dependent on the health and/or development of the Sentient life form(s) itself.

A degraded or less developed Sentient life form requires a greater number of Non-Incarnate Souls to exist at any given time, relative to the number of Incarnate Souls. This is because of the need for more controlled and structured energy forms to assist in stabilising the overall system, with the Incarnate Souls already having quite a task in maintaining the stability of the physical expression that each manifest through.

The Incarnate/Non-Incarnate sequence resembles the Wake/Sleep patterns of a Human Being, with one life of a Human Being resembling a single Wake/Sleep cycle of the Soul. Also, the length of a Souls life is variable from Soul to Soul, just like there is varying lengths of life between Individual Humans. Some Souls expire young, while others grow and develop through the perceived equivalent of millions of years, if not longer.

As a reflection of Human life, there are many threats to a Souls existence, especially when young. These are mitigated as the Soul develops and strengthens, but are never eliminated.

A Soul is strengthened through incarnations and the greater the adversity that can be overcome in each incarnation, the greater the Understanding and Knowing that is gained and hence the more robust and resilient the Soul becomes.

Once developed to a sufficient capacity, Souls may transition from one planetary body to another and Incarnate on those through the different Sentient life forms found there.

An example of this is Earth. It is predominantly occupied by Souls that are not indigenous. Meaning, that they have come from other places and planetary bodies. However, once a Soul is caught up in Earth's karmic cycle, leaving is not so easy, due to Earth's quarantine status. (Given how volatile and unstable most Individuals can get from relatively minor disruptions, is this any surprise?)

In many ways the Soul behaves like a multifaceted lens for Consciousness with each Soul being a finite fractal expression of Singularity. It is essentially the Whole contained within a fragment of the Whole.

*The greater the Understanding
achieved in this lifetime,
the better the platform for the Soul
in subsequent incarnations.*

.

*While One is still breathing,
it is not too late.*

DEFINITION

Sentience or Sentient Life Form – A biological organism that has the capacity to connect with and incarnate an Individual Soul. This equates to an ability/capacity to Self-Reflect; or stated differently, be Self-Aware of One's Individuality.

*

BRING AWARENESS TO THE INNER CONFLICT...

FACE AND ALLOW THE INTENSITY...

A RESOLUTION WILL COME.

A BEAUTIFUL ACHING



A BEAUTIFUL ACHING

UNIVERSAL/CREATION CONSCIOUSNESS

THE MOMENT, THE MIRROR

The Moment is Truth.
The Moment is Eternal.
The Moment is the Forever Now.

What passes through this Moment
is the Transient, the Illusion,
the Forever changing Face
that Reflects back
to the Faceless Eternity.

At a moment in time when all Inner Conflicts have been resolved and Self-Reflection is allowed to reach a high level of Intensity, Self-Ignition takes place and Self-Illumination results.

At this point, Awareness has transitioned so close toward Singularity that Inner and Outer cease to exist. To extend the analogy from the verse, [The Direction Of Resolving Conflict](#), Awareness has transitioned so deep into the depths that it has almost reached the bottom and there is virtually nothing left behind it, so everything will appear before it. Everything appears as Outer and in effect, One is turned inside-out.

Some experiences and features of Universal Consciousness are,

- The Void. The Question Mark (?).
- Transcending the Algorithm. Transcendence of Duality.

INFINITE REFLECTIONS

Finite Awareness
creates an Echo, a Reflection.

Dualistic aspects are those
Echoes and Reflections,
which manifest as opposite
expressions of one another.

Infinite Consciousness
has no Echo, has no Reflection.

It is,
Singularity.



A BEAUTIFUL ACHING

S SINGULARITY

WHAT NOW?

Well...

Now it's up to You.

What has and will be presented here, is not Knowing, nor is it even Understanding.

The only thing that is being offered, is Direction.

Understanding and Knowing are things One must discover for themself.

Through that, Singularity will eventually blossom.



A BEAUTIFUL ACHING

A APPENDIX A - SUPPORTIVE VERSES

From this point forward, all verses can be considered Appendices to the preceding core verses. They will be supportive material that will add colour and variation to the main theme of this work.



A BEAUTIFUL ACHING

BEWARE, THE EXPERT

“The Expert” is One that can be of great value to those that require and rely on the information and understanding that *“The Expert”* can provide. They themselves have most likely investigated and researched the field in which they are proficient for a considerable amount of time and have presumably developed a solid understanding, along with a strong foundation of knowledge, from those endeavours.

However, not all Experts are created equal and not all Experts motivations are always honourable, regardless of any claims made. So, these then are factors which must be taken into consideration whenever evaluating the information and advice from *“The Expert”*.

“The Expert” that functions from a core of integrity and principle will be aware of and acknowledge the limitations of their own understanding. They will offer insights and perspectives with no requirement that others must abide by the information or advice they impart.

Censorship is not something they would endorse either, because allowing the free flow of ideas and opinions helps correct errors and refines understanding. Even absurd and outlandish perspectives should not be suppressed, given that only when expressed openly, does the opportunity arise to show them to be illegitimate.

“The Expert” that may be operating under ulterior motives will often be presented, or present themselves, as the *“go to authority”* in a particular field and that their pronouncements must be followed and adhered to without question.

These are also the type that will eagerly seek censorship of contrary viewpoints, because they are fully aware that they cannot successfully debunk opposing perspectives, due to their information being based on contrivances, not actual facts and reason.

To assume that all Experts are unbiased, facts-based puritans, that can never be unduly coerced or influenced in their opinions, is insanely naive. *“The Expert”* can be

influenced by economic, ideological, corporate and political factors, or their prejudices could simply stem from a base desire for social status.

“The Expert’s” area of proficiency can not only be used to clarify understanding in a certain topic, but it can also be used to skew and misdirect any discussion should there be a sinister motivation on their part. Especially when being questioned by those that may not be as well informed on the subject under scrutiny. They are often used to provide the intellectual cover and justification for insane policies or courses of action that political actors may wish to pursue.

When political or corporate players roll out *“The Expert”*, either overtly or covertly, to substantiate their authoritarian positions, alarm bells should sound loudly in all those that may be affected. For *“The Expert”* is the new battering ram that is used to smash any dissension that may be in the way of an oncoming tyranny.

*Good Ideas do not need
to be imposed onto Others.*

*Good Ideas naturally
spread themselves.*

But the fundamental reason to not just automatically comply with *“The Expert”*, is that *“The Expert”* could simply be wrong.

If an individual makes a decision based on a lack of understanding and that poor decision has catastrophic consequences, then the outcome would only affect that individual and possibly their family or community, depending on their sphere of influence.

When a small centralized ruling class of a large population makes a decision that turns catastrophic, then the fallout effects the entire population, whether all the members of the population willingly participated or not.

These rulers and their “*Experts*” will often claim that the issues they are responding to could have drastic effects on the whole population, but quite often these assertions are vastly exaggerated to drum up political support for their authoritarian actions.

The failures of course, are never the fault of the authoritarians, there is always some other group or some other circumstance that is invariably responsible and “*The Experts*” will be paraded around to attest to this official and “*correct*” version of events, no matter how absurd.

In the end, false Experts and their authoritarian handlers have the potential to destroy entire societies and often do.

What I do, is for the greater good.

The Tyrant’s Mantra



A BEAUTIFUL ACHING

THE NO RISK FALLACY

Alternatively, The Fallacy of Guaranteed Safety & Security.

Nature's primary role is to devise circumstances and situations that stimulate Awareness, encouraging it to stir, while consequently keeping it fresh and vibrant. Thereby establishing the opportunity for Awareness to engage and resolve Conflicts in a more creative and efficient manner, which in turn allows it to penetrate deeper into Being.

Human Beings in a hunter gatherer setting will be subjected to many natural threats and dangers, to keep Awareness primed and highly tuned. Survival is completely dependent on One's ability to be Aware of their environment and innate capacity to adapt.

Societies that are heavily structured toward eliminating all Risk, will not only fail in that regard, but will create dull, comatose husks that barely function as real Human Beings, due to the lack of meaningful stimuli to arouse and challenge Awareness. But then, maybe that is the point of creating such societies.

However, Nature will not allow this kind of situation to persist indefinitely.

If a society becomes so comfortable and decadent to the point that Awareness is stagnating in a very shallow state of Being, it will conceive the necessary catalysts to re-enliven and re-invigorate Awareness into activity. This means that, if Nature needs to create tyranny to awaken a population out of its lethargic state, then Nature will create tyranny.

In fact, wannabe tyrants are ever-present, they exist to take advantage of lapses in vigilance, even in societies where Awareness is highly advanced. Their role being analogous to the sickness and diseases of the Physical Body.

Sick societies give tyrants the foot hold that they require to potentially destroy societies.

A BEAUTIFUL ACHING

Risk is built into the foundational structure of Life. No authoritarian or their laws are ever going to eliminate Risk, no matter the claims made or guarantees given. Elimination of Risk, even if it is only perceived, leads to apathy, ignorance and arrogance, which then opens the door for tyranny to establish itself.

Just like diseases of the Physical Body, open tyrannies are generally relatively short lived. A serious disease that is not resolved quickly will eventually kill the host. Tyrannies that are not put in check promptly within a society, will ultimately destroy the society. This is because tyranny is based on a fundamental corruption and corruption has the seed of its own destruction built right into it.

*Tyranny prefers to operate in the deep,
dark shadows for as long as possible.*

*Because once it is widely exposed,
the light of Awareness shines upon it,
which then leaves it extremely vulnerable.*

Nature has infinitely more tricks up its sleeve to stimulate Awareness than the ego has workarounds. This ensures that the rot of stagnation does not overcome all of Creation, with Nature's ultimate trump card being death itself.

Levels of Safety and Security are something an Individual decides for themselves, possibly in voluntary co-operation and exchange with others. They weigh up all factors that they may be aware of and determine the degree that is adequate for them.

Authoritarian forms of Safety and Security are neither Safe nor Secure. Because authoritarians demand that their mandatory dictates be followed by all. If not, violent retribution will result for those that refuse to comply.

So how then, is this Safe & Secure?

*The greater the Conflicts in the Inner world,
the greater the Tyranny in the Outer world.*

*The deeper the Conflicts in the Inner world,
the more hidden the Tyranny in the Outer world.*

Referring to Humanity as a Whole



A BEAUTIFUL ACHING

T THE MYTH OF RANDOMNESS

Truly Random events do not exist.

The Sun does not Randomly rise in the North and set in the East, nor does it Randomly disappear during the day and reappear at night.

A cat does not Randomly give birth to a carrot, nor do dogs Randomly sprout from the ground.

An apple tree does not Randomly fruit elephants, nor does a wild flower Randomly grow to the size of a redwood tree.

There is nothing in all of Creation that was ever Random and there is nothing that ever will be.

A seed that falls from a tree does not Randomly end up at a particular place on the ground. The location from which it may eventually sprout is determined by many factors, some of which are,

- Wind.
 - Speed, strength and direction of wind will play a significant part in where a seed ends up.
 - Wind movement through and around surrounding objects and obstructions will also contribute substantially to its final resting place.
- Temperature.
 - Colder temperatures lead to increases in air density, which means the seed experiences a slight increase in resistance to its descent and is therefore affected more by any prevailing air currents.

A BEAUTIFUL ACHING

- Areas of sun and shadow respectively heat and cool local air pockets and thus influence fluctuations in air movement for the local environment.
- Humidity.
 - Greater humidity also increases air density, which again leads to an increase in resistance for the falling seed.
- Rain.
 - Light rain may make the soil “*sticky*”, hindering the seeds ability to move too far from the place of its initial landing.
 - Heavy rain may cause flooding, which carries the seed far from the tree from which it originally derived.
- Weight.
 - The lighter the seed the more it will be affected by atmospheric conditions, possibly finding itself farther from its place of origin than a seed of greater weight.
- Space and Time.
 - Each seed starts off from its own unique place in the tree and the time of release has its own prevailing conditions, which all contribute to the seeds “*Right Time*”.
 - Space and Time variations can play a significant part in where the seed ends up. The environmental and atmospheric conditions around the particular tree will invariably change from one moment to the next.

All of these Inputs and many, many more are the predetermining factors for the final resting place of the seed. None of these events are Random. All have their own predetermining factors, while all of those also have their own predetermining factors and so on.

Additionally, the seed itself becomes a predetermining factor for other events.

It may sprout and develop into a whole new tree; it may become food for certain animals to consume; it may decompose, feeding micro-organisms and adding fertility to the soil, which then feeds other plants...

If Randomness actually existed, then fields of study like science and mathematics could not. Because what is the point of scientific investigation, if every specific event or action has a Random outcome? It would be impossible to gain any meaningful Understanding of anything.

SO, WHAT IS RANDOMNESS?

Randomness in the context of science and mathematics is a statistical concept. It is used as a simplification tool. It reduces all the unknowns that contribute to a particular outcome into a possibility.

Determining, let alone Understanding, all the variables that contribute to the outcome of a specific event is incomprehensible to current Human Understanding. It is impossible to compute the exact outcomes of Natural events due to the fact that all of Creation would need to be modelled. This requirement comes about because of the fundamental interconnection of all things, the Universal Whole.

Of course, modelling all of Creation is functionally not possible, refer to the verse [A Discussion About Models](#). Additionally, it creates Self-Referencing issues, refer to the verses [Crash The Algorithm, Part One](#) and [Division By \(0\), A Conceptual Exercise](#).

The concept of Randomness leads to the idea of Probability and so, the best that can be achieved when attempting to determine outcomes to events, is Approximations and Probabilities.

As an aside, some may consider mathematics to be the foundation of Creation. This is not the case, mathematics is used to approximate Creation, it is a language that defines and describes. It is not the Source of Creation or Universal Origin itself.

THE RANDOM NUMBER GENERATOR

In mathematics and computer science there is a procedure known as the Random Number Generator.

This is an algorithm and like all algorithms it requires an Input, from which, it produces an Output.

The operations performed on the Input are predetermined, so for a given Input there will always be a specific Output. These operations may become complex enough to give the impression of Randomness, but complexity does not equate to actual Randomness.

The Random Number Generator does not produce authentic Random Numbers, but only simulates the concept of Randomness. It cannot produce true Randomness, because true Randomness is contrary to the very nature of an algorithm.

Essentially, Randomness itself is only a convenient concept used for mathematical purposes.

Given that the Human Being is an outcome of Nature and Nature is an algorithm with predetermining Inputs leading to specific Outputs, does then the Human Being really have Free Will?

Or, like Randomness, is “*Free Will*” simply a convenient concept?



SCIENCE AND THE UNIVERSE

Science is not Truth.

*Science is a means by which
Truth may be discovered.*

Science **is not** the foundation of the Universe.

Science is a **field of study** that explores and examines the Universe as a way for Awareness to gain Understanding. Refer to the verse, [The Human Consciousness Model](#).

The view of Science as being at the heart of the Universe leads to a warped perspective of Science, it creates a worship of Science. It turns Science into a dogmatic religion that must be believed and never questioned, with its practitioners becoming priests; rather than Science being correctly recognised as a potentially valuable tool for the seekers of Truth.

But a tool is only as useful as its foundational creation allows for and its outcomes are dependent on the quality and competence of those that adhere to its strict methodologies.

Misunderstanding this tool will achieve distorted perspectives, which could lead to catastrophic outcomes.

Misuse of this tool, intentionally or not, may have equally disastrous ramifications should the allure and seduction of its potential not be countered by the balancing nature of [Wisdom](#).

If the wielders of Science come to opinions that do not fully align with the True reality of the Universe, then it is not up to the Universe to conform to the Science. Universe

cares nothing about these misunderstandings. The Universe will continue on as it is and the abusers of Science will eventually reap the consequences of their ignorance and arrogance.

Science has its limitations, one of which is, that it cannot explore areas where Awareness has not yet reached.

*If the Scientific understanding is superficial,
then the Scientific solutions offered,
are also superficial.*

An example of this is pain killing drugs. Pain killing drugs are based on Scientific understanding, but pain killers do little to resolve the cause of pain. All they do is mask it and possibly add their own unwanted side effects.

A second limitation of Science is, a Scientifically valid solution does not automatically equate to an appropriate solution.

One may treat 100 Individuals suffering from chronic pain with a bullet to the head and claim a 100% success rate in curing these Individuals from pain. Ignoring the mass murder component, this is Scientifically valid. 100% of people treated with this protocol, are no longer experiencing any pain.

Ah! Wonderful Science.

At best, all that Science can really establish, is that Action *A* will result in Outcome *B*. It makes no determination on whether Action *A* is appropriate for a particular situation, or whether Outcome *B* is appropriate for a particular situation.

One is to determine this for their own specific requirements and circumstance.

Another limitation of Science is that it can only explore the tangible world, the world of the Algorithm, it cannot reach the realm of Consciousness. Its scope is limited to the expressions of Consciousness, because itself is an expression of Consciousness.

For Science to be able to explore Consciousness directly, it would need to exist outside of Consciousness, which is just not possible. Refer to the verses [The Infinity Of Singularity](#) and [Foundation Of Duality](#).

The path toward Consciousness runs parallel with Awareness for a time, but the road for Science eventually reaches the Threshold of the Abyss, which it cannot cross and must therefore be left behind, if Awareness is to reunite with its Source.

*Real Science Endeavours to
Discover and Confirm Truth.*

*Contrived Science Serves
a Political Agenda of
Control and Manipulation.*

Scientific experiments isolate a particular aspect of Creation, to study it and gain Understanding of it. Often, the Subject of that study is taken out of its natural environment so variables can be more easily controlled and their influence more accurately measured.

However, all this does is show how the Subject behaves in this isolated situation, it does not necessarily show how the Subject behaves in its natural environment.

Consider an Individual interacting with a group of their closest friends. Now also consider that same Individual being placed amongst a group of complete strangers. From One's own personal experiences, it can be easily deduced that this Individual will behave differently amongst their friends, than they would amongst strangers.

It is logical to expect that their behaviour will differ. This is natural, different surroundings will evoke different behaviours.

This variation in behaviour holds true for all things.

A BEAUTIFUL ACHING

Scientifically studying Subjects out of Context, will not necessarily give real insight into their true nature.

So, scientists may claim that their theories and experiments are accurate and valid, but are they really?

REFERENCES

Wisdom – References the verse, Wisdom.



A BEAUTIFUL ACHING

T THE ILLUSION OF GROWTH

Economic growth is a topic that central bank, government and corporate actors salivate over, which is all well and good, provided that the growth is organic and based on real, substantive free market conditions.

But what if the actual growth is not to the liking of these players, yet they wish to present the case that it is? How could they go about creating the illusion of growth if no such growth existed?

What is presented here is not a specific approach that may be taken, but the principle underlying what may be possible.

HOLLOW OUT THE CORE TO MAINTAIN THE FACADE

Consider a solid sphere of say 100 millimetres (4 inches) in diameter, made from a particular substance. For this sphere to be able to grow in size, it would require more of the same material from which it is made to be deposited evenly on to its surface, then as this accumulation continues the greater its mass and diameter would become.

But suppose this material is in short supply or no longer available, how could the sphere then grow?

One may conclude that the sphere could not grow in size, because there is no material available to contribute to its diameter and therefore its mass.

Well, that is somewhat correct, there is no material available to add to its mass but there is material available that could contribute to its overall size.

If the intent is to only make the sphere larger in diameter, then an approach that could be taken to achieve this is to use the material at the core of the sphere and place it evenly onto the surface of the sphere. Thereby increasing its diameter whilst

A BEAUTIFUL ACHING

maintaining the same mass. The sphere would not be any heavier than it originally was, only larger.

So, if the purpose is to create the appearance of growth, then all One need do is transfer the mass at the core of the sphere and place it on the surface. Essentially, Hollowing Out the Core to Maintain the Facade; the facade of growth that is.

To the external observer the increase in size is seen as legitimate because the external observer is unable to see the inside of the sphere or feel the weight of the sphere. Either of these occurrences would give the game away.

However, the problem with this approach comes when the wall thickness becomes thinner and thinner the more this ruse is perpetuated. Eventually, the wall thickness becomes so thin that it is no longer be able to support its own weight and at that point the sphere will collapse in on itself, with the hoax then being exposed.

For instance, if One is to consider the above example of the 100 millimetre (4 inch) sphere, the increase in diameter that is possible by hollowing out its core in the manner suggested, is presented in Table 1 below.

WALL THICKNESS (mm)	DIAMETER OF HOLLOW SPHERE	WALL THICKNESS (inches)	DIAMETER OF HOLLOW SPHERE
50	100.0	2.000	4.000
40	100.3	1.750	4.003
30	102.5	1.500	4.022
20	110.6	1.000	4.215
10	139.0	0.500	5.110
5	187.6	0.250	6.780
2	290.7	0.125	9.362
1	409.2	0.063	13.126
0.50	577.9	0.031	18.506
0.25	816.7	0.016	26.144
0.10	1291.1	0.008	36.958
0.05	1825.8	0.004	52.260

TABLE 1

To be clear, this table presents a condensed number of steps to get to a diameter of 1825.8 millimetres (52.260 inches) and a wall thickness of 0.05 millimetres (0.004 inches) by incrementally removing material from the inside of the sphere and transferring it to the surface. To achieve this in a practical and methodical manner would require thousands upon thousands of iterations. (Refer to the Clarification and Methodology sections at the end of this verse)

What is to be noted with this example is the trend in behaviour, rather than the repetitious detail.

Starting with an original solid sphere diameter of 100 millimetres, it is possible to create a hollow sphere with a diameter of 1825.8 millimetres and a wall thickness of 0.05 millimetres by following the above approach.

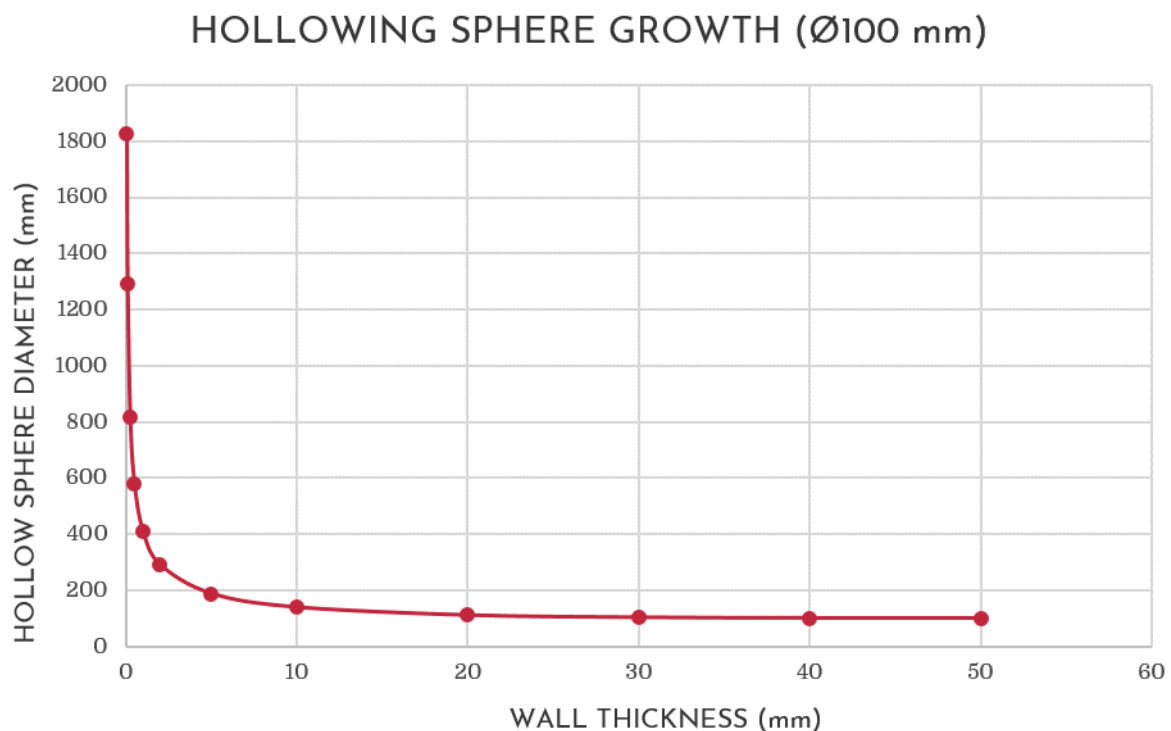

Starting with an original solid sphere diameter of 4 inches, it is also possible to create a hollow sphere with a diameter of 52.26 inches and a wall thickness of 1/256 inches by following the above approach.

HOLLOWING SPHERE GROWTH (Ø4 inches)

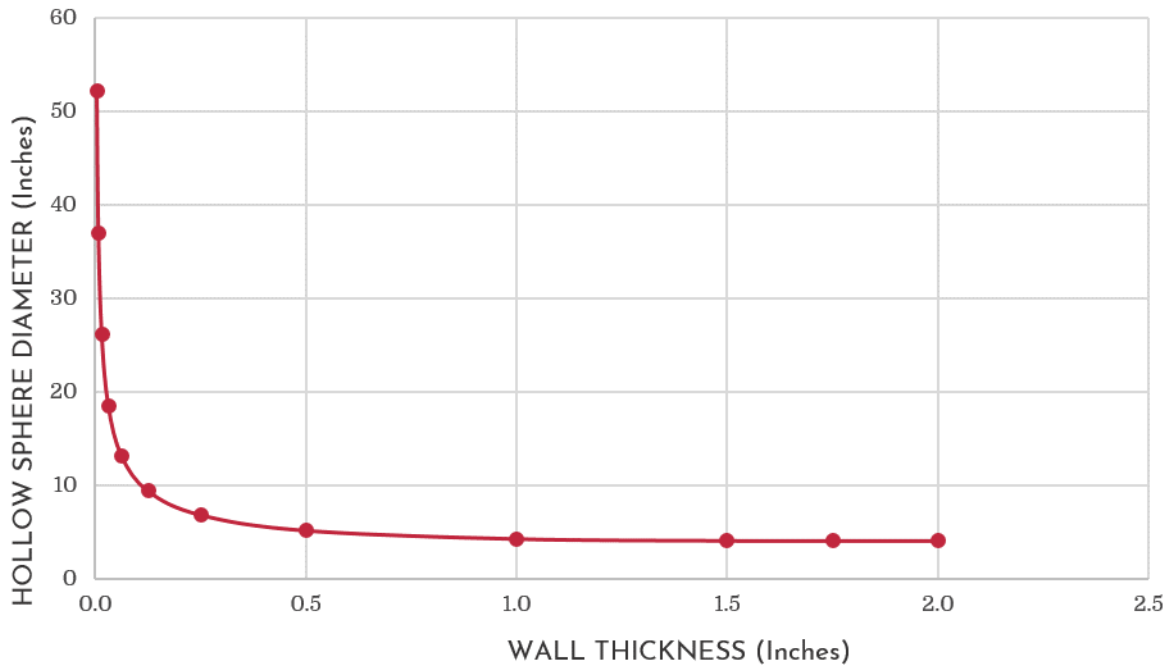

As a comparison, the image below shows the relative size difference of the original solid sphere and the largest hollow sphere presented in [Table 1](#).

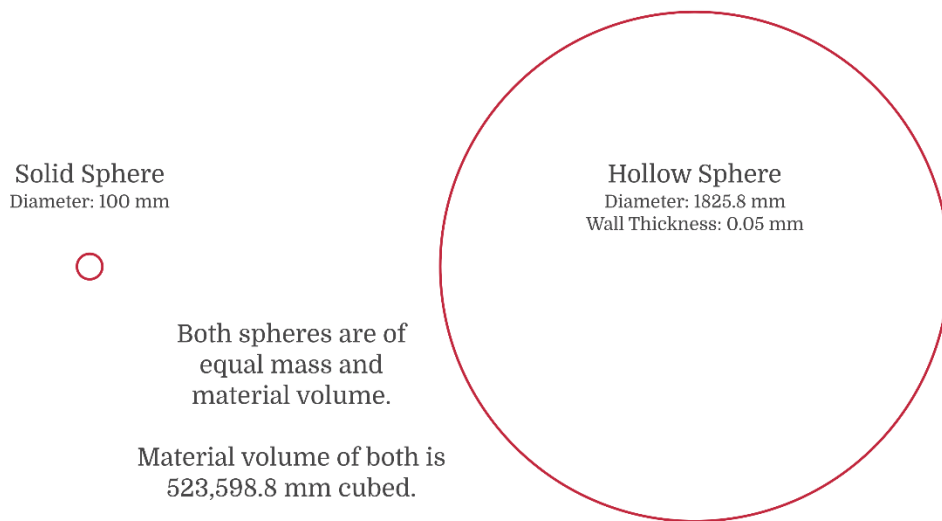

HOLLOW OUT THE CORE TO MAINTAIN THE FACADE SPHERE COMPARISON

Obviously, the external diameter of the sphere can be made to appear impressively large. But what may not be so apparent at face value, is that the sphere lacks any real

substance. All its mass is spread out onto its flimsy skin, resulting in a thin veneer, ready to collapse.

The only question is,

“How long before it collapses?”

In an economic context, what is the primary instrument that is used to Hollow Out the Core to Maintain the Facade?

The Central Bank.

CLARIFICATION

The tables and charts presented in this verse are based on a constant volume, constant density premise. That is, the mass is unchanged as the outer diameter and wall thickness changes. So if the same material is being transferred from the core to the outer surface, then the material volume does not vary.

METHODOLOGY

The process summary for Hollowing the Sphere is as follows;

Iteration 1

Step 1 – Start with a Solid Sphere Diameter.

Step 2 – Determine the Solid Sphere Volume.

Step 3 – Select the Core Diameter.

Step 4 – Calculate the Core Material Volume.

Step 5 – Calculate the Increase in Diameter.

Step 6 – Calculate the Wall Thickness.

A BEAUTIFUL ACHING

Iteration 2

Step 1 – Determine the Diameter for Material Removal.

Step 2 – Calculate the Material Volume for Removal.

Step 3 – Calculate the Increase in Diameter.

Step 4 – Calculate the Wall Thickness.

Iteration 3 and on

Repeat Iteration 2 until the desired number of iterations is reached.

For a more in-depth explanation of the process and calculations that were developed to produce these tables and charts, refer to Appendix B, Hollowing The Sphere Calculations.

Table 2 has been compiled to give an indication of the enormous number of steps required to get to the 0.05 millimetres wall thickness entry in Table 1, using this methodical approach.

ITERATION NUMBER	WALL THICKNESS (mm)	DIAMETER OF HOLLOW SPHERE (mm)
0	50.000	100.00
1	27.002	104.00
2	18.177	113.36
3	13.926	123.03
4	11.436	131.98
5	9.793	140.13
13	5.018	187.24
49	2.013	289.75
137	1.004	408.47
387	0.500	577.88
1091	0.250	816.73
1500	0.202	908.26

TABLE 2

The chart below shows the trend line for the first 255 iterations of the full methodology.

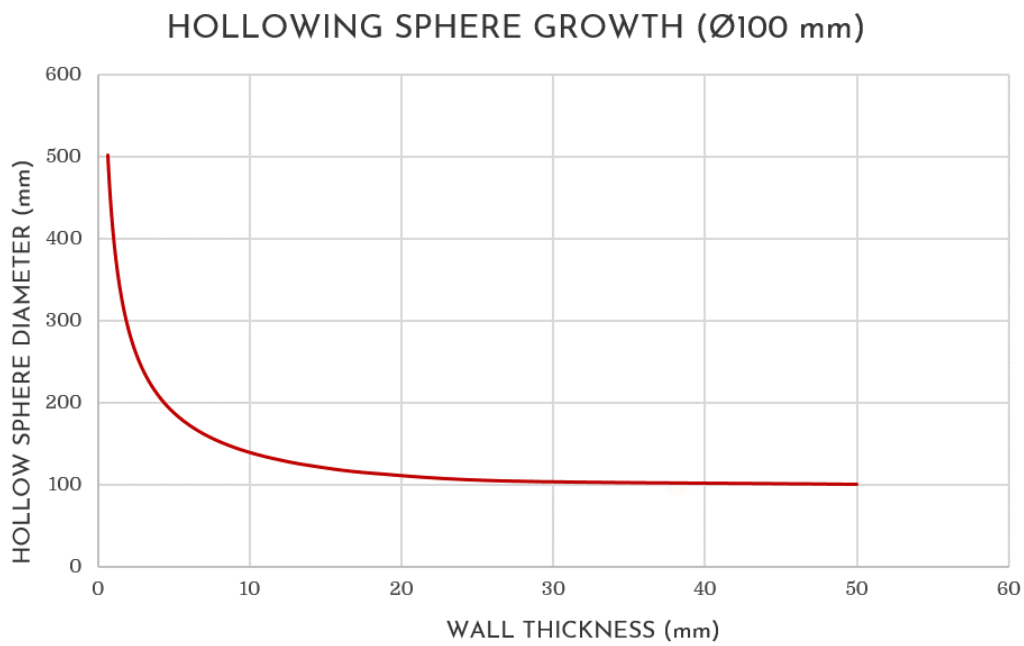



R ROOM TO BE AFRAID, ROOM TO FAIL

*If no space is given for
One to be Afraid or to Fail,
then no room is available for
Strength, Courage
and Resilience to grow.*

If young Individuals are sheltered from feeling Afraid or not allowed to Fail in endeavours that they pursue, then the skills and abilities to Overcome cannot be developed. So the resilience to persevere against seemingly insurmountable obstacles can never mature and ripen.

This then eventually culminates into feeble and inept adults, which are easily coerced and manipulated because they quickly capitulate in the face of adversity. Or in some instances, they react violently as a way to mask weakness and feign [Strength](#).

In times when it is almost considered a crime for One to feel Afraid, the prevailing attitude is, that the catalyst which triggers the Fear must be destroyed, even if that catalyst itself had little to do with the underlying cause of Fear.

If One is Afraid, allow for the space to be Afraid.

If One has Failed, allow for the space to reflect on the Failure.

The sense of Fear, in and of itself, has never caused anyone any harm, regardless of the Intensity.

However, reactions to Fear have contributed to death and destruction on a monumental scale.

ENOUGH ROPE

The opportunity to experience
consequences for choices and actions
should often be given.

Because it is from this,
that real Understanding is gained.

Being constantly sheltered
from any adverse effects,
causes expectations to swell
for perpetual pandering.

.

Provided there is no
immediate physical danger.



A BEAUTIFUL ACHING

THE AUTHORITARIAN STATE

The Authoritarian State and its Indoctrination systems do their best to shelter young Individuals from confrontational experiences, so they do not develop essential skills of resilience and thus never learn to truly Overcome. Because if they did, young Individuals may grow up and not require the Authoritarian State at all, owing to the fact that they would no longer be dependent on the Authoritarian State.

The underlying role of the Authoritarian State is not to protect and serve, nor provide safety and security; its real goal is to create Dependency. The more dependent a population is on the Authoritarian State, the greater its Political Power over a subservient population.

The reason why Indoctrination Systems often go out of their way to shield the young from things like “*Bullying*”, is because the Authoritarian State does not want Individuals becoming able and proficient in dealing with the “*Bully*”.

Should Individuals develop capabilities to contend with the minor bullies in their life, they may eventually develop the capacity to resolve the ultimate bully, which is the Authoritarian State itself.

But of course, it is unthinkable to Authoritarians that their precious State could simply disintegrate into dust.

*When a Religious system of control
is the basis for your Political system of control,
then all that can be expected from this,
are empty platitudes about Individuality and Freedom.*

AUTHORITARIAN VS LIBERTARIAN DEMOCRACY

AUTHORITARIAN DEMOCRACY REQUIRES CITIZENS TO BE	LIBERTARIAN DEMOCRACY REQUIRES INDIVIDUALS TO BE
Cowardly	Courageous
Submissive	Resilient
Docile	Vibrant
Obedient	Self-Motivated
Self-Unaware	Self-Aware
Indoctrinated	Seekers of Truth
Unquestioning	Questioning
Poorly Educated	Well Educated
Easily Manipulated	Well Informed

TABLE 1

Authoritarian Democracy is a poison because it treats Individuals like herd animals that need to be managed and controlled, with citizens being willingly compliant.

Libertarian Democracy encourages Individuality, Self-Expression and Self-Sufficiency, through which growth and greater understanding is gained.

But then, if a Libertarian Democracy actually comes about, what is the purpose of the “Democracy”? In such a society, the “Democracy” is redundant, because these Individuals do not require a centralised political power structure to rule over them.

They do not require “Democracy” at all.

*“Democracy” is a pathetic belief
in the collective wisdom
of individual ignorance.*

H. L. Mencken

CLARIFICATION

Having Degrees and Doctorates to One's name does not necessarily correlate with being Well Educated.

It could also indicate being Poorly Educated to a high level.

CENTRALIZED POWER

Centralized power/control systems and structures are antithetical to Nature.

Nature diversifies points of failure to ensure that one point of failure does not destroy all of Creation.

Centralized political power structures require enormous amounts of time, energy and resources to maintain because of this. As Nature is always in the process of breaking them down, encouraging a reassessment and restructure.

These systems are highly inefficient because they are so antagonistic to Nature.

The more a system moves in the direction of greater centralization, the greater the forces that will arise to counter the effort and the more inefficient the system becomes.

It's only Natural.

In the end, Nature will prevail. One way or another.

*Real Power blossoms
through One that is
fully willing and accepting
to be Powerless.*

POLITICAL PARASITES

Three primary aspects currently make up what is considered a country or nation.

1. The country, the landmass.
2. The country, the people and culture.
3. The country, the political institutions.

The political institutions seek to convince that they are synonymous with the other two.

This is like a parasite convincing the host that the parasite is a benefit to the host and is a part of the host.

REFERENCES

[Strength](#) – References the verse, [Strength](#).

[Authoritarian State](#) – References the verse, [The Anti-Authoritarian Party](#).

[Indoctrination](#) – References the verse, [Teaching vs Indoctrination](#).

[Political Power](#) – References [Supplemental Post 8](#), Exygen Charter, found in Appendix C.



A BEAUTIFUL ACHING

OBJECTIVE TRUTH

One may contend with the prospect that there is no such thing as Objective Truth and all sorts of arguments can be examined to possibly substantiate the claim.

But then, if there is no such thing as Objective Truth, how can any argument be made denying Objective Truth?

The fact that an argument is being considered at all implies an Objective Truth, because all arguments are presented to assert an Objective Truth.

That is the purpose of an argument!

To promote the denial of Objective Truth is to claim an Objective Truth and with that very assertion the idea is instantly torpedoed, even before any details are offered.

*When presented in the right way,
Truth makes sense.*

Whereas, lies have to be believed.



A BEAUTIFUL ACHING



REFLECTION OF PERFECTION

*A Reflection cannot lie.
A Reflection will only present...*

What IS.

Given a flawless reflecting medium

Creation itself cannot be in error, because Creation is simply a Reflection; a Reflection of Singularity.

Singularity cannot be in error, because to judge One as faulty, means that a comparison is being made to Another, that is not.

But Singularity is “*One and Only One*”, there is no Other. So Singularity must be Perfection, because comparison to Another is just not possible.

LIVING PERFECTION

*Life, is Dynamic Perfection.
Death, is the idea of a Static alternative.*

One will make mistakes, but a mistake does not condemn One to be an imperfect Human Being.

One will be prone to errors, but an error does not denounce One as a faulty Individual.

A BEAUTIFUL ACHING

The Perfect Human Being makes mistakes, is prone to errors; but learns from them, adapts because of them and thus grows from the Understanding, the Knowing that springs forth.

This, is the role of the Human Being!

Imperfect are those that are immobilised at the thought of a mistake, paralysed by the fear of an error.

Likewise, those that continuously repeat the mistake and rerun the error.

Never Discovering what is there to be Discovered.

Never Understanding what is there to be Understood.

Never Knowing what is there to be Known.

*Defining Perfection as
never making a mistake,
is Defining Death.*

*Defining Perfection as
an Adaptation to
Exploration and Discovery,
is Defining Life.*

RECOGNISING PERFECTION

Whether Creation/Life is seen as Perfect or Imperfect, is dependent on any preconceived ideas of what Creation/Life should be.

If One sees a juicer as a pasta machine, they will then consider the juicer an Imperfect pasta machine. This is because they have incorrectly identified what the device is and what the device is used for.

Creation/Life is Perfect, when recognized for what it IS and its actual purpose Understood. This has previously been outlined in the verses, [The Fundamental Process Of Nature](#) and [Nature, The Algorithm](#).

CHASING PERFECTION

Attempting to attain Perfection
is like a dog chasing its tail,
because Perfection already IS.

Instead, One is invited to strive
for Accuracy and Precision,
rather than Perfection.

As Accuracy and Precision
will help expose the Perfection,
That IS.

*Some like to use the excuse,
“Nobody’s perfect.”
as justification for continued
weakness and stupidity.*

REFLECTION OF TRUTH

The Universe is not Created
from a desire to be a particular way.

The Universe is a Reflection
of what Creation actually IS.

When One looks into a Mirror,
One does not manipulate
the Reflection to show them
what they want to see.

The Reflection shows them
what they actually are.

.

Creation is not a vanity project.

REFLECTION OR PROJECTION?

DEFINITIONS

Self-Reflecting – Outwardly expressing One's sincere and genuine nature.

Self-Reflection – Unqualified acceptance of whatever is Reflected back, Pleasant or Unpleasant, then honestly assessing it for validity.

Ego-Projection – Projecting a facade of how One is desired to be Outwardly seen.

Ego-Validation – Accepting only that which is Pleasant and reinforcing to the desired facade.



A BEAUTIFUL ACHING

PERCEPTION OF IMPERFECTION

*How many more must be sacrificed,
just to appease the next, "Saviour of the World"?*

When One perceives the world as Imperfect, then One may set out to correct this offence, by requiring all Others to concede, or endure the consequences.

But then, Another sees what has been done and to address this affront, they enforce their own ideology, until conformity is reached, willingly or not.

However this shall not do, so yet Another will endeavour to bring about "*Utopia*"; because their self-righteousness deems them to be the authority in this regard.

Hence, this process continues, until every lunatic decides, "*I Know Best!*" and all Others must comply, or face shameful retribution for any display of insolence.

For who would dare question the wisdom of such sages, that atop ornately gilded soapboxes decree, "*The World is Wrong!*", but accept no responsibility for the chaos and destruction their petulance delivers.

Maybe the original error was not with the world itself, but with the perception of what the world, should be.

Maybe it is the perception of error, that needs to be Understood first, rather than belligerently forcing change, to accommodate One's own personal fears and insecurities.

*Calamity ensues when
Inappropriate Solutions
are applied to
Misunderstood Problems.*

GENIUS BY COMPARISON

When a Fool exclusively associates
with those that are even more foolish,
then the Fool thinks themselves
a Genius by Comparison.



A BEAUTIFUL ACHING

STILLNESS OF THE SPINNING DISC

The verse, [Understanding Space/Time](#), sets up the premise that the centre of a Circle has no Space and therefore experiences no Time. This verse will continue with that assertion by using an example of a spinning disc to reinforce the claim.

A rigid disc spinning about its centre is represented in the diagram below.

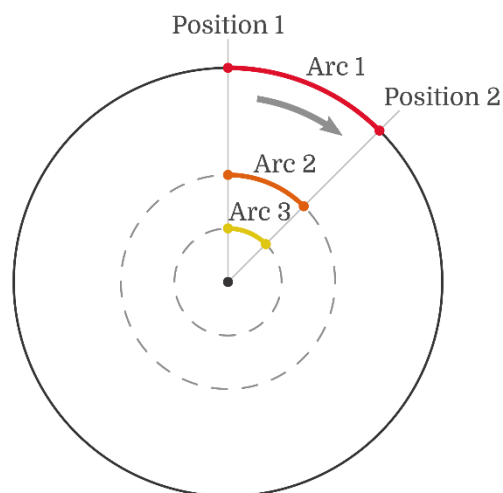

THE SPINNING DISC
STILLNESS OF THE CENTRE

As this disc rotates from Position 1 to Position 2, it can be observed that the distance travelled along each of the three arcs decreases, the closer the arc is to the centre of rotation.

That is, Arc 3 is shorter than Arc 2 which is shorter than Arc 1. ($\text{Arc 3} < \text{Arc 2} < \text{Arc 1}$)

The time to move from Position 1 to Position 2 is the same for all three arcs, given that the disc is rigid. So what this reduction in length of the three arcs indicates, is that the

A BEAUTIFUL ACHING

speed of movement along each arc is also decreasing, the closer the arc is to the centre of rotation.

From this finding, it can be extrapolated that the closer the arc of rotation is to the centre of rotation, the slower the movement along that arc from Position 1 to Position 2.

Extending this reasoning further, when the arc of rotation finally reaches the Absolute Centre of rotation, which is also the centre of the disc, movement ceases altogether.

If considered from the perspective of the points placed at either end of the three arcs, it is apparent that these end points are converging as the arcs get closer to the centre. Then, at the Absolute Centre of rotation, they merge and become one point. Which shows that there is no movement there, because there is no longer any separation between the two points.

This is the case no matter how fast the disc may be spinning.

The Absolute Centre of rotation, Transcends the movement of rotation.

The Absolute Centre of rotation, Transcends Space/Time.

At the Absolute Centre of rotation, there is nothing but Stillness, Silence, Singularity.

CLARIFICATION

It should be noted that the important aspect here is the Centre of Rotation. The centre of the disc is only incidental in this case.

The reason why a disc has been chosen in this example, is that the Centre of Rotation happens to coincide with the centre of the disc, which would also be the centre of mass, if the disc was an actual physical item of uniform density.

Rotation of an object around a point that is not its centre of mass, creates an imbalance which then induces vibration at sufficient speeds.



A BEAUTIFUL ACHING

R REPRESENTING THE CIRCLE

The Circle can be used to describe and represent many aspects of Universe/Creation, the most prominent of which are,

- The Circle can represent Singularity.
- The Circle can represent the Universe.
- The Circle can represent the Whole.
- The Circle can represent Duality.
- The Circle can represent Consciousness.
- The Circle can represent the Individual.
- The Circle can represent Time.
- The Circle can represent Infinity.

THE CIRCLE AS SINGULARITY

On its own, the Circle is *“One and Only One”*.

THE CIRCLE AS THE UNIVERSE

The Universe is a self-contained Whole, which the boundary of the Circle represents. But as many other geometric shapes can also be considered self-contained wholes, the Circle possesses a unique quality, since the distance from its centre is equal to all positions along its boundary. The term for this distance is of course, the radius.

A BEAUTIFUL ACHING

Now, if this radius is of Infinite length, then not only is the Circle of Infinite size, but the centre of this Circle can then be placed anywhere within the Circle and still be the centre of this Infinite Circle.

How is this possible?

Because no matter where the centre is positioned, it is always an equal, Infinite distance to the boundary, in this case, no boundary. Which by definition, is a Circle, albeit, an Infinite Circle.

In three-dimensional space, a sphere of Infinite radius describes the same situation.

THE CIRCLE AS THE WHOLE

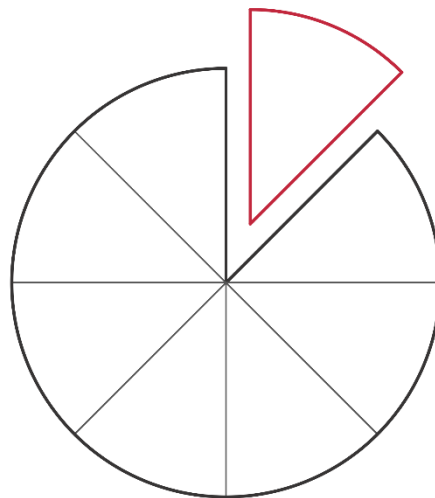

CIRCLE AS THE WHOLE
PIECES OF THE PIE

The Circle can be divided into pieces, but these pieces together create the whole Circle.

Similar to the way pieces of a pie make up the whole pie. However, each piece of pie is also a self-contained whole.

THE CIRCLE AS DUALITY

As was mentioned in the verse, [Foundation Of Duality](#), the origin of the Circle cannot be detached from the Circle as a whole, otherwise the Circle ceases to exist.

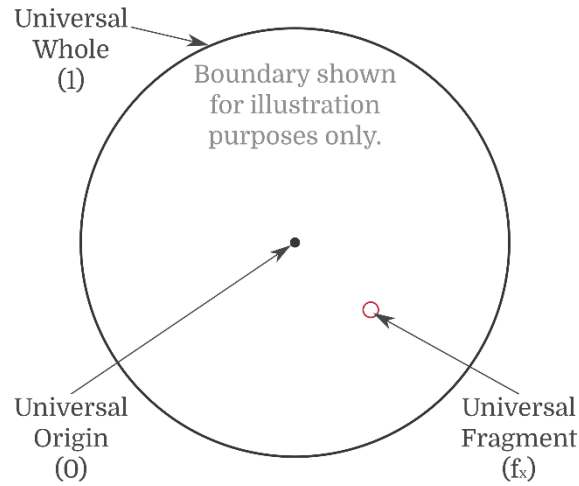

SINGULARITY MODEL
THE CIRCLE

The Circle is the Origin and the Origin is the Circle, they are simply two aspects of the same thing. It is this indivisible relationship that shows the Dualistic nature contained within the Circle itself.

THE CIRCLE AS CONSCIOUSNESS

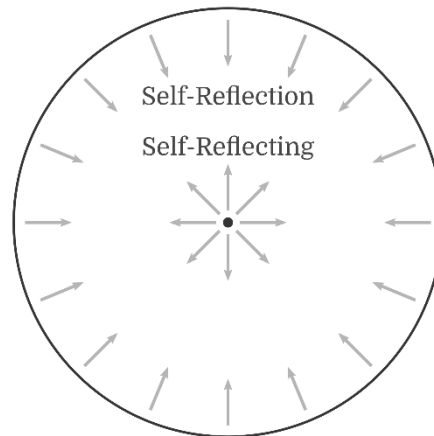

CONSCIOUSNESS MODEL
SELF-REFLECTING vs SELF-REFLECTION

The diagram above represents what the terms Self-Reflecting and Self-Reflection indicate in the context of Consciousness.

A BEAUTIFUL ACHING

Self-Reflecting denotes a reflection expressing from the Source/Centre of the Circle out toward the Boundary.

Self-Reflection illustrates a reflection coming back from the Boundary toward the Source/Centre of the Circle.

In this instance, the Boundary refers to the temporally finite boundary states created by manifest reality.

This process, in a very basic manner, describes the Reflecting nature of Consciousness within itself.

THE CIRCLE AS THE INDIVIDUAL

An individual Circle is “*One and Only One*”, a self-contained whole or an Indivisible Duality. The verse, Dualistic Counterparts, explores this “*Interesting Observation*”.

THE CIRCLE AS TIME

The Centre of the Circle can depict the Moment, while the Boundary of the Circle portrays Eternity.

Thus, the Moment is the source of Eternity, as Eternity is expressed from the Moment and contained within the Circle itself, is all of Time.

THE CIRCLE AS INFINITY

Consider the Circle as a regular polygon with Infinite, equal length line segments. Reducing the resolution of this polygon creates the standard regular polygons, which can then be deemed approximations of the Circle.

A polygon is a closed, two-dimensional shape, bounded by three or more straight line segments.

A regular polygon is a polygon where all the line segments are of equal length and all the internal angles are of equal magnitude, as presented in the diagram below.

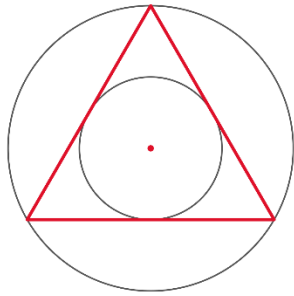

Triagon
3 Sided Circular
Approximation

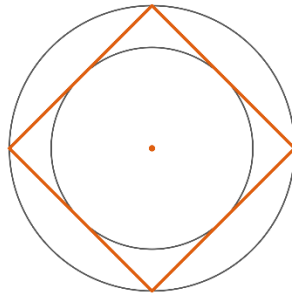

Quadragon
4 Sided Circular
Approximation

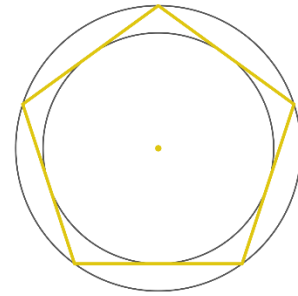

Pentagon
5 Sided Circular
Approximation

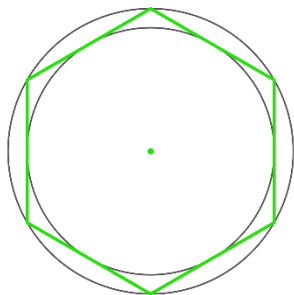

Hexagon
6 Sided Circular
Approximation

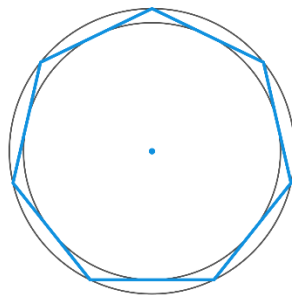

Heptagon
7 Sided Circular
Approximation

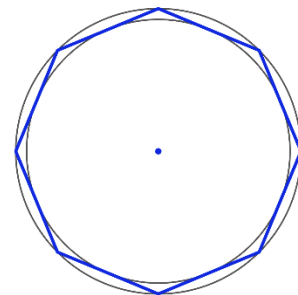

Octagon
8 Sided Circular
Approximation

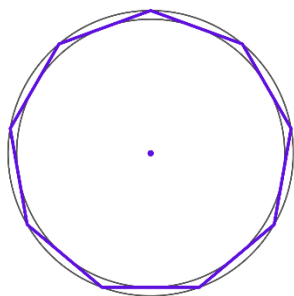

Nonagon
9 Sided Circular
Approximation

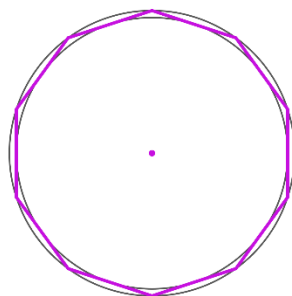

Decagon
10 Sided Circular
Approximation

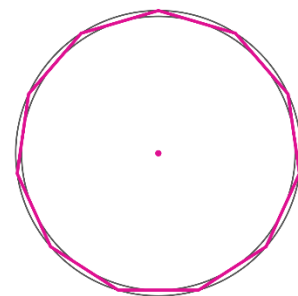

Hendecagon
11 Sided Circular
Approximation

REGULAR POLYGONS AND THE CIRCLE

POLYGON CIRCULAR APPROXIMATIONS

Standard regular polygons are shapes such as a Triagon (Equilateral Triangle), Quadragon (Square), Pentagon, Hexagon, Heptagon, Octagon, Nonagon, Decagon.

As the number of line segments is increased, the polygon more closely approximates and resembles the Circle. Increasing the number of line segments to Infinity, then gives the Circle its true form.

A BEAUTIFUL ACHING

At this stage though, these line segments are no longer actual line segments, but instances of Singularity. Because the distance between the two end points of each line segment has been reduced to zero.

So essentially, the Circle can be thought of as an Infinity Polygon or "*Infinagon?*".

The most fundamental approximation of the Circle as a regular polygon, is the Triagon. This is because three is the minimum number of line segments possible for a polygon.

There are two ways that a regular polygon can approximate a Circle.

1. Inscribed Circle – Where the Circle is tangential to each line segment of the polygon at its midpoint. This has the Circle within the polygon.
2. Circumscribed Circle – Where the Circle intersects each of the vertices of the polygon. This has the polygon within the Circle.

The Triagon, being the most fundamental approximation of the Circle, presents the situation that the size difference between its Inscribed Circle and its Circumscribed Circle is the most extreme out of all the regular polygons. Increasing the number of line segments of the polygon, has the diameter of the two Circles converging closer together.

Then, upon reaching an Infinite number of line segments, the Infinity Polygon, the Inscribed Circle and the Circumscribed Circle all attain the same diameter. All become the same Circle. Could they even be regarded as, a "*Wholly Trinity?*"

Extending this comparison into three-dimensional space has the Platonic Solids, or more specifically Geodesic Polyhedra and Goldberg Polyhedra, portray the Sphere in a similar way.



A BEAUTIFUL ACHING

POLYGONAL CONVERGENCE

Regular polygons present natural convergences and divergences when coupled with their circumscribed and inscribed circles. This verse will primarily deal with the convergence aspect, as divergence follows a similar template, only in the opposite direction.

Polygonal Convergence is the term that will be used to describe the diminishing pattern that is created when the inscribed circle of a regular polygon becomes the circumscribed circle for the next iteration of the parent polygon.

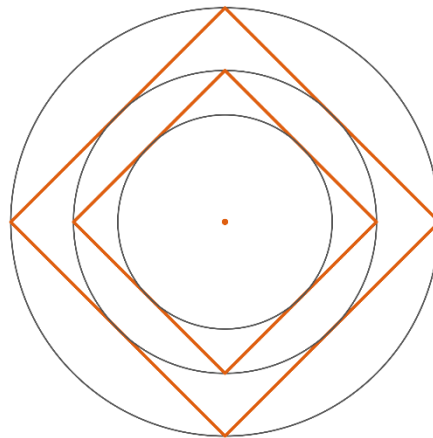

POLYGONAL CONVERGENCE
DIMINISHING PROPORTION

The larger Quadrangle in the above diagram is shown with its circumscribed and inscribed circles.

In the Polygonal Convergence process the inscribed circle becomes the circumscribed circle for the next polygon in the sequence and following from that, the next inscribed circle is generated.

A convergence pattern follows a structured reduction progression and each subsequent polygon will be reduced by the same factor from its predecessor. This Polygonal Convergence Factor is unique to each specific regular polygon and can be readily ascertained by following the steps below.

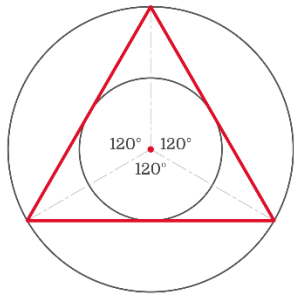

1. Triagon
Polygonal Angle

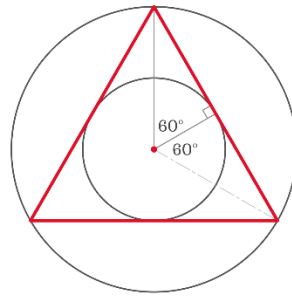

2. Triagon
Radii Angle Relationship

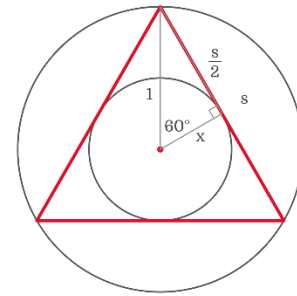

3. Triagon
Convergence Factor

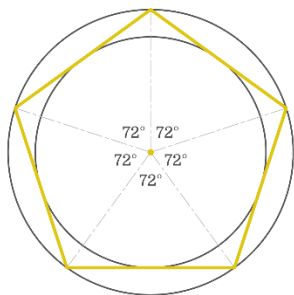

1. Pentagon
Polygonal Angle

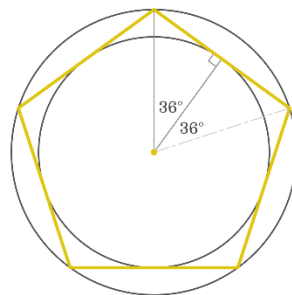

2. Pentagon
Radii Angle Relationship

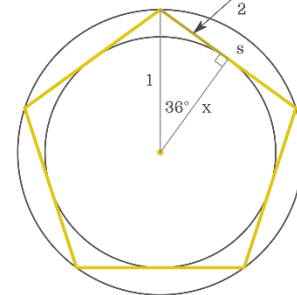

3. Pentagon
Convergence Factor

POLYGONAL CONVERGENCE FACTOR

CIRCUMSCRIBED vs INSCRIBED CIRCLES

1. POLYGONAL ANGLE

The first item that is to be determined is the Polygonal Angle and this angle is produced by extending two connecting lines from the centre of the polygon to two adjacent vertices.

In the case of the Triagon, the Polygonal Angle is 120° and for the Pentagon it is 72° , as shown in the above diagram.

To determine this angle, simply divide 360° by the number of vertices found on the regular polygon in question.

The reason for this, is that the vertices in a regular polygon are dividing the circle equally. Therefore, the angle formed by two connecting lines from the centre, to two adjacent vertices, will be the Polygonal Angle.

$$\text{Polygonal Angle} = \frac{360^\circ}{n}$$

Where,

360° = One revolution of a circle.

n = Number of regular polygon vertices.

The number of vertices happens to also correspond with the number of polygon line segments.

2. RADII ANGLE RELATIONSHIP

Next, by extending a line from the centre of the circle/polygon to the intersection point of the inscribed circle and polygon, creates a right-angle triangle. This intersection point coincides with the midpoint of the polygon line segment, since the inscribed circle is tangential to this line segment at its midpoint.

Establishing this right-angle triangle now defines a relationship between the radius of the circumscribed circle and the radius of the inscribed circle, with the angle between the two being half the Polygonal Angle.

3. CONVERGENCE FACTOR

Finally, by using trigonometric relationships, the length of the inscribed circle radius can be resolved. In the case of the Triagon, the trigonometric relationship which determines the inscribed circle radius, x , is,

$$\cos(60^\circ) = \frac{x}{1}$$

$$x = \cos(60^\circ)$$

$$x = 0.5$$

Where,

60° = Half the Polygonal Angle of a Triagon.

x = Inscribed circle radius.

1 = Circumscribed circle radius.

A BEAUTIFUL ACHING

So what this now gives is the Polygonal Convergence Factor for the Triagon, because the original circumscribed circle radius is set to 1.

This means that each subsequent Triagon in a Triagonal Convergence will be reduced in size by a factor of 0.5 from its predecessor.

A generalised representation of this relationship which is applicable to all regular polygons is,

$$x = \cos\left(\frac{360^\circ}{2n}\right)$$

$$x = \cos\left(\frac{180^\circ}{n}\right)$$

Where,

x = Polygonal Convergence Factor.

n = Number of regular polygon vertices.

$360^\circ/2$, takes into account that half the Polygonal Angle defines this relationship.

The table below shows the Polygonal Angle and Convergence Factors for the first nine regular polygons.

POLYGON	NUMBER OF VERTICES	POLYGONAL ANGLE	CONVERGENCE FACTOR EQUATION	POLYGONAL CONVERGENCE FACTOR
Triagon	3	120°	cos(60°)	0.5
Quadragon	4	90°	cos(45°)	0.7071
Pentagon	5	72°	cos(36°)	0.8090
Hexagon	6	60°	cos(30°)	0.8660
Heptagon	7	51.43°	cos(25.71°)	0.9010
Octagon	8	45°	cos(22.5°)	0.9239
Nonagon	9	40°	cos(20°)	0.9397
Decagon	10	36°	cos(18°)	0.9511
Hendecagon	11	32.73°	cos(16.36°)	0.9595

TABLE 1

Some of these Convergence Factors present interesting proportions.

$$\text{Triagon} = \frac{1}{2}$$

$$\text{Quadragon} = \frac{\sqrt{2}}{2}$$

$$\text{Pentagon} = \frac{\varphi}{2}$$

$$\text{Hexagon} = \frac{\sqrt{3}}{2}$$

Where φ (phi) is the Golden Ratio

CONVERGENCE DENSITY

As has been established in [Table 1](#), these Polygonal Convergence Factors approach 1 as the number of vertices is increased. This then leads to convergence patterns that increase in density with the higher order polygons.

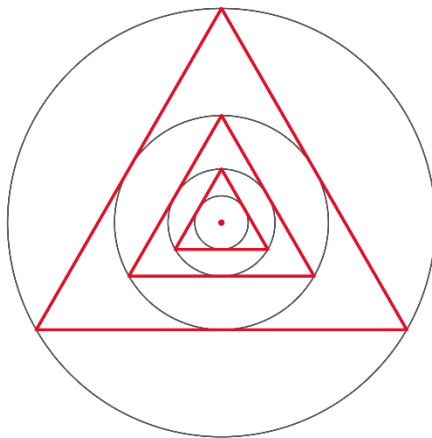

Triagonal
Convergence Density

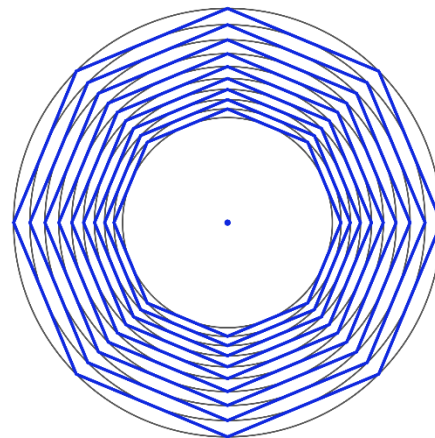

Octagonal
Convergence Density

CONVERGENCE DENSITY POLYGONAL CONVERGENCE

SYMMETRIC CONVERGENCE

Symmetric Convergence is a term that defines convergence patterns where the subsequent convergent polygon has the same angular orientation as its predecessor.

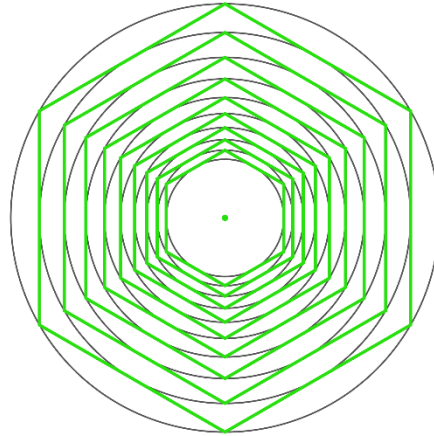

SYMMETRIC CONVERGENCE
HEXAGONAL PATTERN

ASYMMETRIC CONVERGENCE

The term Asymmetric Convergence is used to define convergence patterns where the successive convergent polygon is rotated by half its Polygonal Angle as compared to its predecessor.

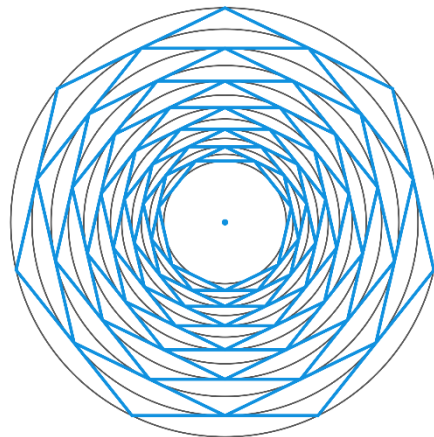

ASYMMETRIC CONVERGENCE
HEPTAGONAL PATTERN

These types of geometric patterns and structures could be considered Inwardly Infinitely Self-Reflecting, since the convergent figure is a fractal image of its predecessor and the process can be continued indefinitely.



A BEAUTIFUL ACHING

POLYGON SPIRALS

Previously in the verses, [Representing The Circle](#) and [Polygonal Convergence](#), the relationship between circles, polygons and convergences was discussed. Delving deeper into the possibilities that materialise out of these associations yields Convergent Polygon Spirals. These types of Spirals are generated by tracking a point on each subsequent propagation of a particular Polygonal Convergence pattern and fitting a smooth curve through them.

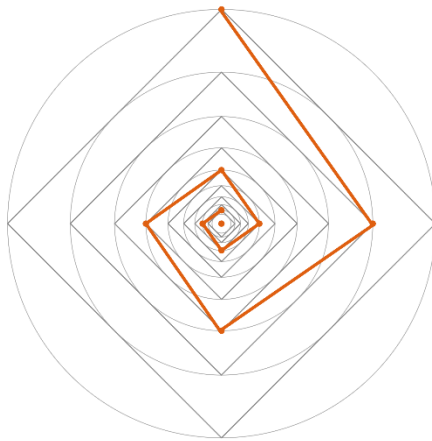

Connecting Points
Quadragonal Convergence

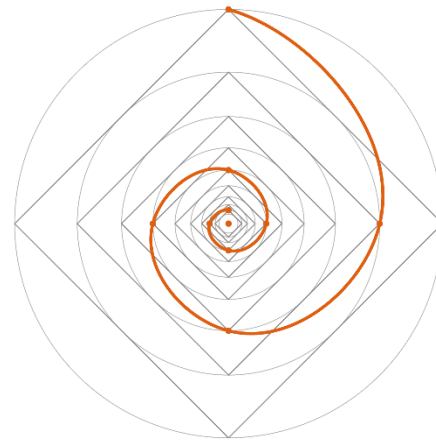

Smooth Spiral
Quadragonal Convergence

POLYGON SPIRAL QUADRAGONAL SPIRAL

For example, the way a Quadragon Spiral is created appears in the diagram above. The Connecting Points image uses straight line segments to show the polygon vertices that are to be connected via the emergent Spiral. The Smooth Spiral image is what arises when a spline curve is fitted to those points.

These connecting points are determined by,

1. Selecting a vertex on the outer most polygon of a convergence pattern.

2. Rotate either clockwise or anti-clockwise around the centre of the circle/polygon, while also transitioning inward to the next polygon in the convergence.
3. Upon rotating an amount that is equivalent to the Polygonal Angle, the next point is located at the vertex of this subsequent polygon.
4. Repeat steps 2 and 3 for however many vertices are to be connected in the developing Polygon Spiral.

SPIRAL DENSITY

Polygonal Convergences with higher order regular polygons produce denser convergence patterns. It follows then, that Spirals generated from these higher order Polygonal Convergences will produce denser Spirals, as is shown to be the case in the Polygon Spiral Density diagram below.

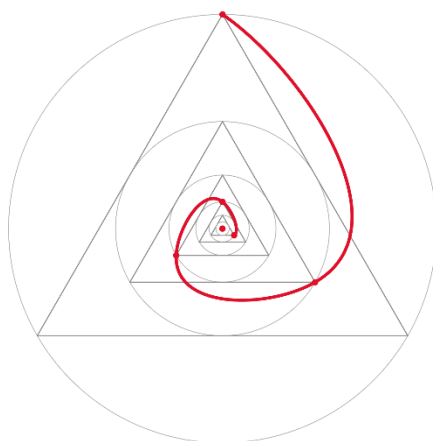

Triagonal
Convergence Spiral

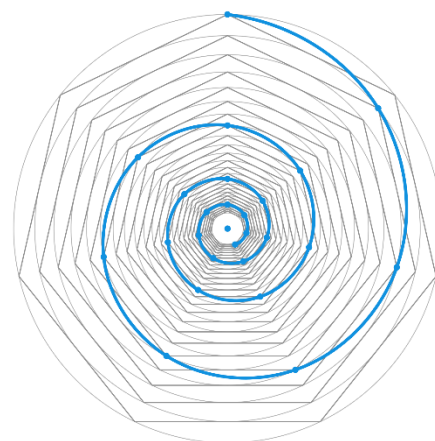

Heptagonal
Convergence Spiral

POLYGON SPIRAL DENSITY

TRIAGON vs HEPTAGON COMPARISON

However, when examining a Heptagonal Convergence Spiral, not only does it display more revolutions than a Triagonal Convergence Spiral, the resultant curve of the Heptagonal Spiral exhibit's gentler transitions through all its connecting vertices.

The Triagonal Spiral possesses a characteristic lobe prior to its transitions. The reason for this is a combination of a greater disparity between the parent Triagon and its

convergent offshoot, plus a larger Polygonal Angle it must rotate through while bridging one vertex point to the next. Thus requiring a more abrupt change in direction as a way to keep the consequent curve smooth.

SPIRAL CONVERGENCE COMPARISON

Polygonal Convergences have two fundamental variances, Symmetric Convergence and Asymmetric Convergence and Spirals can be generated from either variant.

Previous examples above have been founded on Symmetric Convergences, but the diagram below shows the different outcomes obtained by both Symmetric and Asymmetric Convergence, using the Hexagon as a base.

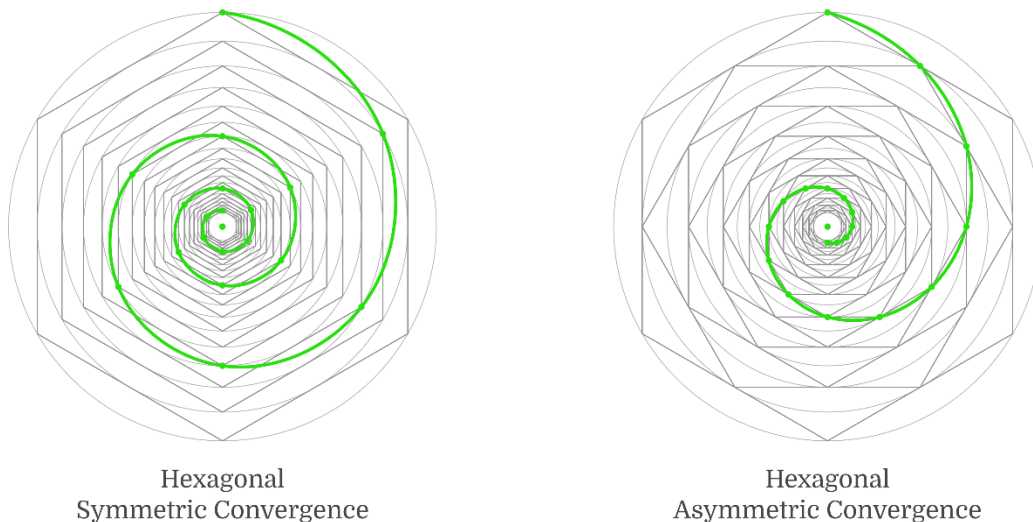

SPIRAL CONVERGENCE COMPARISON

SYMMETRIC vs ASYMMETRIC CONVERGENCE

What this comparison reveals, is that the Asymmetric Convergence Spiral exhibits fewer revolutions compared to its Symmetric counterpart, in a way similar to the Spiral generated with a Triagon source. But it does not possess the characteristic lobe of the Triagonal Convergence Spiral, instead offering a more gradual transition through the vertices of each polygon.

POLYGON SPIRAL ARMS

Finally, not only do these Polygonal Convergence patterns generate one Spiral, but can produce a Spiral for each vertex of the particular foundational polygon. For example,

A BEAUTIFUL ACHING

with the Pentagon having five vertices, it provides the framework for up to five separate Pentagonal Convergence Spirals.

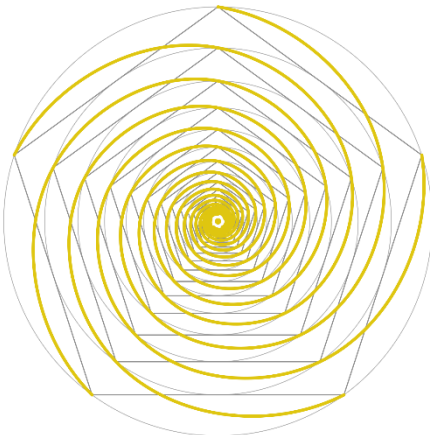

POLYGON SPIRAL ARMS
PENTAGONAL SPIRAL

In closing, Polygonal Convergences and Spirals not only furnish interesting forms in their own right, but can also be used more discretely, by providing the proportional metric for defining scale and elemental relationships within a geometric or artistic composition. Essentially, they can be used as the supportive framework for many types of design work, with their versatility being limited only by imagination.



A BEAUTIFUL ACHING

T THE INSIDIOUSNESS OF WORSHIP

CHARLATANS OF VIRTUE

Charlatans of Virtue artificially reflect
the amassed dim lights of followers
and bask in the glowing spectacle.

True Divinity, has the ability to
Blindly Radiate, all on its own.

Worship is a mask that presents an appealing facade of Reverence and Respect, but behind it lies an insatiable chasm of entitled desire and expectation.

When One Worships Another, be it an Individual or perceived deity, they do so not out of appreciation and admiration, but out of self-serving motivations, driven by chronic fear and insecurity.

However, unreserved fealty has its price and the amount to be paid must reflect the willingness to prostrate Oneself, so eagerly and absolutely.

A price that is readily promised, by those that cannot deliver and have no right to authorise, yet do so anyway, simply to siphon the desperate and the lost.

This price is of course, Eternal Heaven itself.

A nebulous prize, that suits the grandeur of the exhibition and to accept any less, would make a mockery of the ritual.

A BEAUTIFUL ACHING

But to question is not permitted, because if it were discovered that this price cannot be paid, then sentiment could shift, turning exaltation to demonisation, with these vendors of the ethereal finding difficulty maintaining their perch.

Despite all the power they project and adulation they command, not even these grant immunity against a contract thus void.

From the worshipper to willingly worshipped, the entire episode is a display of saddening tragedy. For Divinity so misrepresented, flaunts how skewed and misguided the path has become.

As all things have their time, Truth will eventually prevail and what will then be laid bare, is that Worship is Insidious.

DEFINITION

Reverence – Love and appreciation, without expectation.

*Worship obliges the One being worshipped
to an imagined standard set forth by the worshipper.*

*Reverence and Respect do not demand
any such obligation or standard.*

GENUINE INTEGRITY

One may accumulate “good deeds”
for the purposes of a Heavenly pay-off.

But would One still engage in these pursuits,
if no matter their choices and actions,
Hell eventuates as the final destination?

Genuine Integrity has no expectation for a rewarding bounty.

Whereas Pretence will parade its virtuous veneer,
while expecting prestige and accolades for the performance.

RELIGION = POLITICS

*Religion is just Politics by another name
and like all Political institutions,
organised Religions are simply a vehicle by which
the few exercise power and control over the many.*

If a religious or political institution claims to be the source of attributes like Morality and Integrity, then One may be convinced that the only way to acquire these qualities is by affiliation with this collective group.

Power therefore, resides with the collective authority, because One may not want to be without Morality and Integrity, so must willingly submit themselves to the collective authority.

But the actual reality is, that True Morality and Integrity are aspects of the Individual. They cannot be acquired through osmosis by being physically, emotionally and psychologically amalgamated into a collective.

Only the facade of Morality and Integrity is obtained through association.

True Morality and Integrity, is the Power of the Individual.

*True Morality and Integrity
are not attributes
that are enforced from external
religious or political sources.*

*They are qualities that are
Discovered, Developed and Nurtured
through greater and deeper
Self-Understanding.*



A BEAUTIFUL ACHING

C CAGES AND MURALS

Belief, Worship.

An Emotional, Psychological cage.

Surrounded by walls
with enticing painted murals,
outside the confinement of the bars.

However, the tragedy that belies
this perceived heaven beyond,
is the fact that all this is a dream,
nothing other than hallucination.

In place to contain,
with little effort or oversight.

But to crack open One's eyes,
if only for a glimpse,
the Awe, the Wonder,
the Vast Landscape to behold.

No more bars.
No more cage.
No more murals
to deceive.

Ideology, Religion,
is limiting.

Because that, is the intent.

BREAKING FREE?

Breaking out of a smaller Ideological Prison,
into a slightly larger Ideological Prison,
gives One the false impression,
that they are finally free.

*Birds born in a cage,
think flying is an illness.*

Alejandro Jodorowsky



A BEAUTIFUL ACHING

T THE TREE

The roots of The Tree,
are Conservative in title.
Strong, deep and stable,
requirements most vital.

The trunk and all its branches,
Progressive is their nature.
Reaching for new heights,
grand and graceful in their posture.

Shallow, weak and fragile,
amid ease these roots succumb.
Given stunted trunk and branches,
then feeble is the climb.

Robust in strength and stature,
is The Tree of immense power.
With roots penetrating deeply,
holding firm when winds turn dour.

If trunk is severed from the root,
The Tree no longer integrated.
Death the only possibility,
once cleft and segregated.

The Individual, like The Tree,
is indivisible as a Whole.
Pure Conservative and Progressive,
work together to feed the Soul.

DEFINITION

Pure – Uncorrupted.

*Roots must penetrate
deeply into Darkness,
so Branches gain ability
to reach toward the Light.*

A SELF-FEEDING CONFLICT

So what is one of the most effective methods for tyranny to gain power and control?

By composing the fallacy that the Dualistic aspects of the Whole are aligned against one another.

Thus creating an unnatural, self-feeding Conflict. Which is often expressed as, *“The snake eating its own tail”*.

A Conflict which eventually corrupts and destroys all that engage with it in a partisan manner.

Evil is conceived from the attitude that,

*“My side is always the right side,
because it is the side that I am on.”*

CONSERVATIVE OR PROGRESSIVE

CONSERVATIVE CREDENTIALS

I am so Conservative,
that my Conservativeness
pre-dates Religion.

.

Religion is such Progressive Nonsense.

*

PROGRESSIVE CREDENTIALS

I am so Progressive,
that my Progressiveness
Transcends Superficial Identifiers.

.

They/Them is so Conservatively Yesterday.

*

Conservative or Progressive?

Compared to what?

HALF AN INDIVIDUAL

What is Half an Indivisible Duality?

.

“I’m Right Wing.”

or

“I’m Left Wing.”

.

Really?

Well, instead of cleaving Oneself in Half,

ever considered just Being Whole?



A BEAUTIFUL ACHING

T THE UNRELENTING TEACHER

A Teacher may give credit
for effort and possibly attendance.

A Teacher may have preference
for this position, or that.

A Teacher may deem certain details
trivial and non-essential.

A Teacher may wish to avoid offence,
distress or even embarrassment.

But when it seems that a Teacher
is being overly harsh or perhaps cruel,
remember,
that Nature will be Honest,
Merciless and Unapologetic
in all of its assessments.

Because Nature is,
The Unrelenting Teacher.

THE INSTRUCTOR

One that teachers from Another's texts,
Another's books and Another's curriculum,
is not really a Teacher.

They are an Instructor.

One needs to have something compelling
and unique in the offering,
to be considered an actual Teacher.

INSPIRED SIGHT

The Teacher is One
that willingly Describes
a Masterpiece painting
to the blind.

With the intent
that the Description
will prompt and inspire
sight to be restored.

But however extraordinary
the Description is,
it does not do justice
to the painting itself.

FORMATION OF CLARITY

When dealing with what may
seem like a difficult dilemma,
rather than attempt to fabricate
or formulate a contrived outcome,
allow space for sharp Clarity and
deeper Understanding to develop.

In this way, the natural
solution will emerge.

But it will emerge in its own way,
in its own time, of its own accord.

.

In the end, it may eventuate
that the resolution arises easier, better
and quicker than One would expect.

PRETENDERS BEWARE

One that presents a pretence
of that which they are not,
will eventually be tested as if they are.

A process they will not find pleasant.

With the possible outcomes here being,
One will either rise to the challenge,
or capitulate and fail under the burden?

STEWARDS OF THE EARTH

*Humanity's intended role is
to be Stewards of the Earth.*

Not Rapers and Pillagers of the Earth.

At what point was Value, reduced down to a simple monetary gain?

A BEAUTIFUL ACHING

Is it common to have a spreadsheet tracking the financial viability of,

- A relationship with a partner or a spouse?
- Caring for an ageing parent?
- Providing for a young child?

If this is common, it is preposterous.

Yet, a relationship with the Earth, the Environment, is reduce to,

“How can I benefit?”

*

*“How can I not
be inconvenienced?”*

*

*“How can I exploit
my environment to make it
most profitable to me?”*

The Earth is a Source of Life, the Earth sustains Life.

Where is the Gratitude?

(This is not in reference to the political fiction of man-made global warming.)

*Truth,
Never has been
Or
Ever will be,
Fair and Balanced.*



A BEAUTIFUL ACHING

T THE GAME OF LIFE

*Games have objectives,
which upon successful completion,
lead to victory.*

*In the Game of Life,
the Primary Objective and the Victory is,
Self-Understanding.*

One may try to engage with Life in Candy Crush mode. Where it is amusingly entertaining while passing the time, but on the whole, achieves nothing of substantial value.

Or perhaps, One can immerse themselves in Dark Souls mode. Where it can be merciless and brutal, when the approach is not meticulous in understanding, action and timing. The overwhelming harshness of this mode is not by any gruesome physicality, but by the staggering intensity of emotional and psychological torment.

Candy Crush mode is an option diminishing quickly.

So, is One prepared to step up to the alternate mode, in The Game of Life?

CLARIFICATION

*“...when the approach is not meticulous
in understanding, action and timing.”*

In real life terms, this means the approach lacks Pureness of Intent, actioned through a Foundation of Wisdom.

But then, sometimes suffering will still come, regardless.

A BEAUTIFUL ACHING

Because, that's just Life.

DEFINITIONS

Candy Crush – Originally an internet browser puzzle game which developed into Candy Crush Saga on both browser and mobile apps.

Dark Souls – A skill-based console and personal computer game that is renowned for its unforgiving difficulty and aggravating frustration.



A BEAUTIFUL ACHING

MALICIOUS INTELLIGENCE

*Manipulation and Deception
are Revealers of Truth,
as much as they are
Concealers of Truth.*

Maliciously deceitful and manipulative behaviour only exists within a specific Intelligence band.



MALICIOUS INTELLIGENCE ZONE HUMAN INTELLIGENCE RANGE

Those of Low-Level Intelligence cannot even conceive of deception, let alone possess the ability to construct a contrived and fallacious narrative. The area designated for this scope of Intelligence is shown in the conceptual diagram above.

While those of High-Level Intelligence, realise the misguided folly of operating from a nefariously disingenuous and conniving foundation. Again, as indicated above.

Instances of maliciously deceitful and manipulative practice only occur within Individuals of Mid-Level Intelligence.

However, this middle section is not exclusively made up of those with malevolent intent, it is simply the region in which they will appear. Most Individuals encompassed by this range, will generally exhibit a sincere and reasonable nature.

Also, Intelligence is not a fixed commodity, it is a characteristic which can be improved upon through deeper Self-Awareness.

THE FOOL

One should never be afraid
of looking The Fool.

One should just not aspire
to being The Fool.

Because it is when
One is afraid
of looking The Fool,
that One then
becomes The Fool.

*Busily creating Distractions for Others,
becomes a major Distraction in itself.*

MANIPULATING THE FLACCID

Successful Manipulation and Deception
of the same Individual(s) over and over again,
naturally gives rise to a justifiable Contempt.

.

How can such a Flaccid existence be Respected at all?



A BEAUTIFUL ACHING

FREE WILL?

What is,
“Free Will”?

How is *“Free Will”*
to be defined?

Is *“Free Will”*
the ability to do
whatever One wants,
whenever One wants?

This obviously
cannot be the case.

Is it *“Free Will”*
to make a choice
between two, three
or more options?

Psychology and Emotion
play a complex part in this,
so how much is actually,
“Free Will”?

Is it from *“Free Will”*
that One loves who they love?

Is it a choice that is made,
to love who One loves?

There is Free Will
in allowing Oneself

to unapologetically
love who they love.

But there is no Free Will
in the matter of who
One truly loves.

So, what is,
“Free Will”?

Any definition of *“Free Will”* is absolutely dependent on the fullness of Consciousness.

Limited Self-Awareness is susceptible to all manner of occult manipulation, to an extent that is inversely proportional to the level of Self-Awareness.

DEFINITIONS

Occult – The unseen, as in Occluded.

Free Will – A possible definition.

FREE WILL

The Willingness and Total Acceptance
in Allowing Awareness to Experience
the Complete Fullness of What IS.



A BEAUTIFUL ACHING

THE SOCIAL DEGRADATION SPIRAL

*Strong Leadership
is the Antithesis
to a Strong Society.*

*It is the Strong Individual
that is the Foundation
of a Strong Society.*

A society that is dependent on “*Strong Leadership*” for it to function, means the society itself is weak. The reason the society is weak, is because the Individual is weak.

Weak Individuals require “*Strong Leadership*” to lead them and “*Strong Leadership*” requires weak Individuals to be led.

“*Strong Leadership*” strives to weaken a society, in an effort to exploit and manoeuvre the society to the bidding of “*Strong Leadership*”.

A strong society based on Strong Individuals, will greatly resist any underhanded manipulation from “*Strong Leadership*”.

The field of viable candidates to occupy “*Strong Leadership*” roles will dwindle, as the Individuals within society become weaker.

As a consequence, this results in weak Individuals filling these positions and to compensate for inadequacies, they establish ever more oppressive forms of “*Strong Leadership*”.

Strong Individuals have no requirement for *“Strong Leadership”*. Strong Individuals are the bane of *“Strong Leadership”*.

The demand for *“Strong Leadership”* is a condition that a society anticipating robust stability and longevity should vigorously avoid.

Depreciation of the Individual within society, begins the deterioration of society.

A degraded society then looks for *“Strong Leadership”* to stabilise the society and in doing so, diminishes the Individual even further. Thus leading to a weaker Individual, which then ensures a weaker society, that then calls for even greater enforcement of, *“Strong Leadership”*.

This is, The Social Degradation Spiral.

When talk begins for the need for *“Strong Leadership”*, the Individual, along with society, is in trouble.

THE HIERARCHY OF RESILIENCE

Psychological Frailty
leads to
Emotional Frailty
leads to
Physical Frailty.

Alternatively,

Psychological Robustness
leads to
Emotional Robustness
leads to
Physical Robustness.



A BEAUTIFUL ACHING

T THE INDIVIDUAL'S STAND

When One has the courage
to Stand on their own,
it matters not who or how many
Stands with them.

One does not ask
for permission to Stand,
nor requires solidarity
with others to Stand.

It matters not if another
to their left should buckle,
or any to the right, concede.

It matters not if all
to the front oppose them,
while others behind, attack.

It even matters not
for gods called upon,
to be saviours of the day.

The Strong Individual
will continue to Stand,
resolute, alone if necessary,
long after all else have fallen.

*Every Strong Individual
has a bit of Mongrel to them.*

*But not every Mongrel,
is a Strong Individual.*

DEFINITION

Mongrel – Tenacious and Unruly. Junkyard dog.



A BEAUTIFUL ACHING

WAR HEROES

War is the penalty on all,
for failing to avoid the War.

As it is, the ones enduring
the greatest devastation of the War,
are those that had the least to do
with creating the War.

War is the result of Heroes
failing to stand up before the War.

There are no Heroes, in War.

PERVERSE INCENTIVES

Glorifying an Individual
that is forced into a position
of taking Another's life,
is Perverse.

.

Perverse Incentives.

The caption for
Human Society
to this point.

THE HYPOCRITES OF WAR

All those that cheer for War
and promote Others being sent to War,
should first and foremost take themselves
and their children to the front-lines of War.

Because if there is valid justification for the War,
they should be willing to sacrifice themselves
and their children to the War.

Rather than expect Others
to be sacrificed for them.

THANKS FOR WAR

To those in the Military
that await thanks for their service.

Why should you be thanked
for serving an Oligarch Class,
that uses you to violently plunder the
property and resources of Others,
whilst masquerading these atrocities
in benevolence and virtue?

.

To those in the Military
thinking they serve their
country and its people.

No! You do not.

You serve the Political Oligarchy
and Military Industrial Complex.

These are your Masters.

.

The Military is just another
Government department,
whose role it is,
to serve Government.

PATRIOTISM

Cheering for a Political Construct.

.

My Team has the Biggest Guns.

Yeah!

My Team has the Biggest Bombs.

Yeah!

My Team can Kill the Most People.

Yeah!

.

Militaristic Patriotism.

Cheering points for the Insane.

NAILS, NAILS EVERYWHERE

*When the only tool available is a Hammer,
then every problem looks like a Nail.*

Paraphrasing Abraham Maslow

From a Conflict resolution stand point, if the only tool One has available to them is violence and destruction, then every Conflict they encounter will be resolved in a violent and destructive manner.

Developing and refining different tools for different contexts, means more innovative and fulfilling solutions can be discovered for the Conflicts that are encountered.

DECEPTION IS NO DEFENCE

*Being deceived into killing Another,
does not absolve One of the crime.*

If One were to be deceived or coerced into enacting unjust, malevolent deeds against Another, then Nature's consequences for that action will not befall the Deceiver, but the Deceived.

Deception alone does not violate the Laws of the Natural Algorithm.

Unwelcomed and Unjust actions against a Sovereign Entity does.

This is why very astute Tyrants always induce Others into performing their heinous acts, because the resulting repercussions are serious and they are aware of it.

These Natural consequences have come to be known as, "*Karma*".

Also to this point, Nature does not recognise the Nuremberg Defence of, "*Just Following Orders*", either. Since Nature considers One a Sentient Sovereign entity. Even though, One may not act or see themselves in such a manner.

The Courageous Stand Up to Tyranny.

Cowards Kill on Command.

THE MILITARY MEAT-HEAD APPROACH

Us or Them.

Either,

I Die or You Die.

.

"Warriors", are not
the brightest Individuals.

JUSTIFYING MURDER

Taking Another's life should
never be celebrated or worshipped.

Regardless of the legitimacy.

All this does, is encourage the deranged
to fabricate ways to justify their murder.

.

"Warriors"

Worship Murder.

A TOOL OF TYRANNY

As Anger and Resentment rise
against a Political Establishment,
the Political Establishment
will concoct Enemies and Wars
to Dissipate and Diffuse
the Anger and Resentment.

THE WAR TO END ALL WARS

The War to End All Wars
is the War that destroys
Everyone and Everything.

.

Is this the road
Humanity
wants to go down?

If so, then so be it.

TRUMAN = HITLER

When my side commits Mass Murder,
then we are the Conquering Heroes.

When your side commits Mass Murder,
then you are the Evil Monsters.

.

How is Truman a Mass Murderer?

Hiroshima and Nagasaki.

.

Of course, these people are Japanese,
so they don't matter.

Besides, they're "*Losers*",
because they lost the war.

THE CONSCRIPTION CON

Let all Politicians and Senior Bureaucrats who support Conscription, along with their families, be the first to be Conscripted to the front lines of War.

A BEAUTIFUL ACHING

Then, once they come back in body bags, the rest of us can decide whether to follow their lead.

In all likelihood, the response from most will be...

“Nah, I’m good.”



A BEAUTIFUL ACHING

IDEOLOGY AND RELIGION

DISCLAIMER

Criticisms of Christianity are not exclusive to this particular group of religions. Christianity is simply the one most familiar to the author. Similar criticisms can be made for all organised religions that worship and idolise.

IDEOLOGY

Worshipping an Idea.

Rather than,

Engaging with Truth.

.

Ideas are to be Genuinely
Considered, Contemplated and
Explored for Validity.

Not Worshipped.

A Valid Idea is an Idea
that Aligns with Truth.

MORAL RECOGNITION

An Individual that currently associates
with a particular religious ideology,

should give themselves more credit
for their Morality and Integrity.

Rather than allowing some
parasitic religious institution,
claim credit for something
it played little part in.

GOD VS SINGULARITY

When One refers to “*God*”, they are referring
to something that is not them and is beyond them.

In other words, “*God*” has nothing to do with them.

When referencing Singularity, One acknowledges the Self
and the Self’s place within the Absolute Whole or all that IS.

It is the acknowledgement of, “*One and Only One*”.

VIRTUOUS FACADES

Political Parties and Organisations.

Outwardly facing Virtue.
Inwardly facing Depravity.

.

Organised Ideological Campaigns.

Outwardly facing Virtue.
Inwardly facing Depravity.

.

Organised Religious Institutions.

Outwardly facing Virtue.
Inwardly facing Depravity.

THE MASCOT

Christ himself
has nothing to do
with Christianity.

Christianity uses
the idea of Christ,
as a Marketing Mascot
to sell the Ideology.

THE TORTURE OF CHRIST

Christianity worships the Crucifix.
The Crucifix is a torture device.

.

Christianity worships the Crucifix.
The Crucifix was used to torture Christ.

.

Christianity worships the Crucifix.
Christianity worships the Torture of Christ.

RITUAL CANNIBALISM?

Catholics partake in a ritual of
“Eating the Body of Christ”
and
“Drinking the Blood of Christ”.

Seems rather cannibalistic.

.

Are Catholics engaging in
Mock Ritual Cannibalism?

HIERARCHY OF SINS

The Ten Commandments.

The Seven Deadly Sins.

Yet, no mention against
the sexual abuse of children.

.

*“Thou shalt not take the name
of the Lord thy God in vain.”*

*“Honour thy father
and thy mother.”*

*“Thou shalt not
commit adultery.”*

·
“Gluttony.”

“Envy.”

“Pride.”
·

All more important than
the sexual abuse of children.

Wonder Why?

CHRISTIAN VALUES

*“Thou shalt not covet
thy neighbour’s slaves.”*

But owning slaves is fine.

Because that’s just,
“Christian Values”.

THE GREAT DECEIVER

Christianity considers *“Satan”*,
The Great Deceiver.

Would not the Greatest Deception be,
to worship *“Satan”*,
through the image of Christ?

WHAT VALUE ARE YOU?

What do books like the Bible,
tell you about, You?

They talk a lot about other people
and their stories.

But what about, You?

Who are, You?
What are, You?
Why are, You?
Where are, You?

What do these books
say about, You?

CHRIST SAID WHAT?

Is there any record of Christ actually
speaking about abortion?

Is there any record of Christ actually
speaking about homosexuality?

Is there any record of Christ actually
speaking about divorce?

Yet Christianity takes a position
on all of these things and more,
then attributes it to Christ.

This is not to counter any of these positions,
just a record of presumed attribution.

WHOSE TEACHINGS?

The New Testament
is not the Teachings of Christ.

It is the teachings of the Apostles of Christ.

At best, based on their interpretations
of the Teachings of Christ.

In legal terms, this would equate to,
“Hearsay Evidence”.

WORSHIPPING WHAT?

Creation and the
Human Individual’s place in it,
is not a religious issue.

There is nothing to be
idolised in this relationship.

There is plenty to Discover,
to Understand,
to Know.

But nothing to worship.

RELIGIOUS FOUNDERS?

The Buddha was not a Buddhist.

Christ was not a Christian.

Muhammad was not a Muslim.

NEVER ENDING STORY

...When momentum swings
against the Ideological Lunatics,
be careful that they are not
replaced by Religious Crazies.

When momentum swings
against the Religious Crazies,
be careful that they are not
replaced by Ideological Lunatics...

BELIEF VS TRUTH

Belief is Conjured to Control.

Truth is There to Liberate.

CRUTCHES

Ideology and Religion
are nothing more than
Psychological and Emotional
Crutches.

One cannot stand on their own
as a Strong, Powerful Individual,
whilst holding on to Crutches.

.

Let go of the Crutches.

PERVERTING TEACHING

Schools Teach.
Religions Worship.

Worship creates a
perversion
out of Teaching.

BEYOND THE INDIVIDUAL

Nothing that the Individual
Dreams up, Creates or Expresses
is above or beyond the Individual.

How can it be?

.

Religion is not
above the Individual.

Ideology is not
above the Individual.

Politics is not
above the Individual.

.

All are subordinate
to the Individual.

DIVERSION TACTICS

Religions were not created
to Help One find Truth.

Religions were created
to Hinder One finding Truth.

WHEN THE CAT'S AWAY

Just like Tolkien's work is being perverted
by rats and cockroaches after his death,
maybe the teachings of Muhammad,
Christ and in some part the Buddha,
have also been perverted by the same,
after their deaths.

It is always easier to distort
and misrepresent a creator's work,
when they are no longer around to object.

SUBORDINATING SOVEREIGNTY

Why is Worship so Insidious?

Because One is unknowingly
Subordinating their Sovereignty
to an external authority,
real or imagined.

.

In other words,

*My Friends,
You Bow To No One.*

King Aragorn
The Lord of the Rings,
The Return of the King

WHY EVIL?

If God is the creator of the
Universe and everything in it,
then God created Evil.

Did he not?

If Evil is actually offensive to God,
then God could eradicate it easily.

Could he not?

.

But he doesn't.

Does he?

ONLY YOU

There is no God!

There is just, You.

You are all that ever was.

You are all that ever will be.

At the very Heart of all that IS,
there is only, You.

SANTA CLAUS IN THE SKY

God is the grown-up version
of a Santa Claus in the Sky.

SECURITY BLANKET

God, Ideology is a
Security Blanket
for the Weak.

HALTING DERANGEMENT

Derangement must be
called out for its Derangement.

So the unsuspecting do not get
caught up in the Derangement.

CHOOSING TRUTH?

Truth is not a Belief
the ego gets to Choose.

RELIGION FARMING

Religion's farming operations provide it with,

.

Multiple virtue and guilt-based revenue streams.

A reliable source of indoctrination evangelists.

All the useful idiots it could ever need

to attack and suppress dissent.

And a herd that believes Religion
serves their interests.

.

What a magnificent grift.

DEBATING GOD

Debating the existence of God,
is like a debate between the blind,
to determine whether the Sun
is either Green or Cheese.

One that can See,
does not engage in such nonsense.

ENVIRONMENTAL ADVOCATES

Given that Christianity views God as the creator
of the Earth and every plant and animal on it,
then it is perplexing that Christian religions are not
the greatest Environmental advocates of all.

In fact, they say surprisingly little
on real Environmental issues.

IDEOLOGICAL HUBRIS

“What would Jesus do?”

.

What Hubris to presume
the actions of Christ.

What Hubris to espouse
the qualities of Christ,
solely from Ideological affiliation.

Any Individual
of the quality of Christ,
has no requirement
to evoke Christ.

Such an Individual,
Stands on their own.

WARM FUZZY FEELINGS

When One is Worshipping *“God”*,
what exactly is One Worshipping?

Why at all is One Worshipping?

What does One think they
gain from Worshipping?

The answer to these questions cannot
simply be, for Warm Fuzzy Feelings.

.

Be Aware, that no
Choice or Action
is purely inert.

OBSERVING STUPID

It is intriguing to observe,
an Adult that believes
in a Santa Claus in the sky,
labelling Others as stupid.

CONVENIENT HAND-WAVING

“God works in mysterious ways.”

.

Seems like convenient Hand-Waving to misdirect
from the nonsensical inconsistencies of Religion.

CHRIST IS MY SAVIOUR

Making a statement like,

“Christ is my Saviour”

says one of two things.

.

1.

*“I am lazy and looking to subordinate
responsibility for my life to someone else.”*

2.

*“I am too weak and cowardly
to accept responsibility for my own life.”*

.

Either way, the implication is that,

“Someone else has to do it for me.”

*“Someone else has to deal with
the Burden of being, “My Saviour”.”*

The appropriate response to this is,

“Do It Yourself!”

Then again,
maybe One is just Virtue Signalling
when making the statement,

“Christ is my Saviour.”

Because Virtue Signalling
is a Religious creation.

*I am not
Beholden or Subservient
to no God of yours.*

A BEAUTIFUL ACHING



A BEAUTIFUL ACHING

MORALITY INTERTWINING INTEGRITY

*Morality is not a virtuous garb
that is adorned only
when convenience permits.*

DEFINITIONS

Integrity – The capacity to endure difficulty without boasting of or glorifying achievements. See the verse, [The Structure Of Integrity](#).

Morality – A personal attribute which incorporates a standard of expression and behaviour by which One endeavours to conduct themselves, especially under burdensome conditions. Morality is completely meaningless, if at first sign of adversity it is discarded to the dirt.

Some of these standards of expression and behaviour may include,

- The committed pursuit of Understanding and Knowing Truth.
- Not participating in, promoting or encouraging actions or behaviours which are contrary to healthy, naturally sustainable expressions of Life.
- Not being self-righteous in denying Another's Sovereignty and Freedom to peaceably live their own life, even if it is contrary to One's own personal views and standards.
- Not engaging in any malicious manipulation and abuse of Another, with the goal of simply elevating and advancing Oneself or One's own self interests.

A BEAUTIFUL ACHING

- Not engaging in spiteful retaliation.
- Being willing and prepared to make an unwavering stand against real injustice.

Encompassed in all of this, is the understanding and acceptance that decisions and actions made based on Moral standards, will at times be inconvenient. It may well create difficulty for Oneself and One's own circumstance.

This is where Morality intertwines with Integrity.

*If Morality is abandoned
on the Fear of Suffering,
then One is just a slave
to their Fear of Suffering.*

During the course of One's life, their set of Moral standards may be redefined and refined as life experience, honest evaluation and deeper Self-Awareness deems necessary.

THE SOURCE OF MORALITY

True Morality is not a religious or philosophical contrivance, but a conveyance based on Deep Foundational Self-Awareness.

It is not formulated, manufactured or derived from external sources, but is an Expression of Consciousness manifest through Being.

At the heart of the Genuine, Full Human experience, is a bedrock of True Morality. Those that seek a Genuine, Full Human experience, will naturally be resistive to Immorality.

Immorality will attempt to hide or obscure itself from the mirror of True Morality, because to acknowledge its own ugliness is extremely provoking and offensive.

To compensate for this, it will strive to degrade the Moral base by normalising Immorality, whilst hidden within shadows and acting behind virtuous facades.

Manipulation and pressure will first be brought to bear on those of weakest Moral Integrity, as these will capitulate quickly, thus initiating a wave of capitulation.

All this, in the pursuit of creating a more hospitable environment for open Immoral behaviour.

*Religion does not make
the Moral Individual.*

*The Moral Individual
reflects well on the Religion.*

DEFINITION

What is inferred by the phrase, “*The Genuine, Full Human Experience*” is,

1. Emotional Intensity turned up to 11.
2. Psychological Resilience turned up to 11.

With 10 being the maximum.

Oh! That is on a Logarithmic Scale.

Conceptually speaking.

SUB DEFINITION

A Logarithmic Scale is where a division on that scale has a value 10 times greater than its predecessor.

A Linear Scale has a 1 to 1 relationship with all the divisions on it.

A BEAUTIFUL ACHING

That is,

- The value of the division from 0 to 1 is 1 unit.
- The value of the division from 1 to 2 is 1 unit.
- The value of the division from 2 to 3 is 1 unit.
- And so on.

A Logarithmic Scale has a 1 to 10 relationship with the preceding divisions on it.

That is,

- The value of the division from 0 to 1 is 1 unit.
- The value of the division from 1 to 2 is 10 units.
- The value of the division from 2 to 3 is 100 units.
- And so on.

The reason for this scale is so that data sets with a wide range of values can be displayed in a compact manner.



A BEAUTIFUL ACHING

T THE SHADOW SELF

BALANCING EVIL

Evil is not a
balancing force
for anything.

Evil is the result of a
severely forced imbalance,
in either direction.

It is Darkness
that is the
balancing force
to Light.

Not Evil!

Darkness ≠ Evil

The “*Shadow Self*” is a term that is used to define aspects of Human Consciousness that Awareness is not cognizant of. The phrase, “*Phantom Zone*”, has previously been used to identify this same notion in the verse, [The Human Consciousness Model](#).

Although the Shadow Self is quite dark and difficult to contend with, as it pierces the veil into the Awareness state, the Shadow Self itself is not inherently Evil and does not imply Evil. The verse, [Wisdom](#), gives a context and definition for the concept of “*Evil*”.

A BEAUTIFUL ACHING

The Shadow Self simply means unexplored aspects of the Self, areas that Awareness is fearful and unwilling to go into. This unwillingness to explore the Shadow Self may then potentially culminate in Evil.

But the Shadow Self, in and of itself, is not inherently Evil.

Initial engagement with the Shadow Self may give the impression of Evil.

But the Shadow Self, in and of itself, is not inherently Evil.

Interacting with the Shadow Self can and will be exceptionally difficult.

But the Shadow Self, in and of itself, is not inherently Evil.

The Shadow Self unquestionably holds enormous amounts of pain and unfathomable depths of darkness.

But the Shadow Self, in and of itself, is not inherently Evil.

There is possibility for violent and destructive behaviour if Awareness is lost to the Shadow Self, so maintaining Self-Awareness is key.

But the Shadow Self, in and of itself, is not inherently Evil.

Strong resistance, reluctance and refusal for Awareness to engage with the Shadow Self has some likelihood to manifest into Evil.

But the Shadow Self, in and of itself, is not inherently Evil.

The fear of what is perceived to be within the Shadow Self can provoke Evil reactions, if the Psychological and Emotional Bodies are weak and lack stability.

But the Shadow Self, in and of itself, is not inherently Evil.

Vile Psychological and Emotional experiences can conceivably lead to Evil actions, if Self-Awareness capitulates to the Shadow Self.

But the Shadow Self, in and of itself, is not inherently Evil.

Vile Psychological and Emotional experiences are similar to extensive, chronically infected, puss filled wounds, which upon first exposure can be quite nauseating.

But the Shadow Self, in and of itself, is not inherently Evil.

Once Awareness has been brought to the problematic areas of the Shadow Self and underlying issues resolved, these areas then transform, transitioning from being part of the Shadow Self, to integrating with the Awareness state of Knowing.

But the Shadow Self, in and of itself, is not inherently Evil.

The Shadow Self is there to impart deep levels of Insight and Understanding, once its wounds are exposed and begin to heal.

But the Shadow Self, in and of itself, is not inherently Evil.

AVOIDING DARKNESS

If One continuously avoids Darkness,
then Nature must continuously Amplify Darkness,
to get Acknowledgement and Acceptance of Darkness.

.

There is no limit to Nature's ability to Amplify.

For an overview of the reasoning and creation of the Shadow Self, please refer to the verses, [Crash The Algorithm, Part One](#) and [Crash The Algorithm, Part Two](#).

A BEAUTIFUL ACHING



A BEAUTIFUL ACHING



OPPORTUNITY COSTS OF CREATION

As has been stated in the previous verses, [The Fundamental Process Of Nature](#) and [Nature. The Algorithm](#), Creation is the manifestation of Consciousness. It is the vehicle for Consciousness to gain greater Understanding of itself, with Nature being the Algorithm that facilitates this process.

Those aspects of Creation that best contribute to the Primary Objective will be supported by Nature, because they are considered to be of most value to Creation. The resources expended in supporting these is well worthwhile.

Those aspects that are failing in this Primary regard, will be stimulated to improve and permitted opportunity to correct and align with Creation's objective, given the constantly changing contextual framework.

However, if improvement is not forthcoming, then it becomes an inefficient use of resources to maintain a failing organism or system.

Thus, Nature will take steps to remedy this and re-purpose these resources into areas that further advance the Primary Objective.

The more a Human Individual aligns with the Primary Objective, the more they will be sustained by Nature, in terms of personal health and well-being, along with subsidiary resources.

If an Individual is not interacting with Life in a fitting manner, why then would Nature expend resources on them?

This is also the case for Humanity as a whole.

So, One could now ask,

*“Who does it harm,
if I don’t engage with Life?”*

*

*“Who does it harm,
if I don’t look after my own
health and well-being?”*

*

*“Who does it harm,
if I avoid facing and resolving
deeply held fears and insecurities?”*

*

*“Who does it harm,
if I buy in to a particular
ideology or religion?”*

*

*“Who does it harm,
if I rigidly comply to
lifelong indoctrination?”*

*

*“Who does it harm,
if I wallow in decadence?”*

*

*“Who does it harm,
if I participate in
a little corruption?”*

*

“Who does it harm?”

Everyone!

One may not see or experience the harm in the present. But all these things are an indication of stagnation and Nature cannot allow stagnation to persist indefinitely.

Nature will cause disruption to stimulate the stasis, in an attempt to re-establish healthy, vibrant Energy Flow once more.

Nature will destabilise rigid belief and thinking, to encourage Awareness to explore more deeply and intently.

Because if it cannot, then there are many other places these resources would better be utilised.

Opportunity Costs may give a superior return elsewhere, or in another form.

This applies not just to the Individual, but to Humanity as a whole.

REPREHENSIBLE COWARD

The Coward is Reprehensible.

The Coward avoids difficulty or any situation that may induce fear.

The Coward grovels to appease for personal favour and acclaim.

The Coward is belligerently petulant, when backed by political authority.

A BEAUTIFUL ACHING

The Coward is such a lowly creature,
that even Creation values the Tyrant
more highly than the Coward.



A BEAUTIFUL ACHING

T THE POWER OF CREATION

When One expresses a creation
that is truly exceptional,
they are not proud of it,
they are not boastful of it,
they are not egotistical about it.

Instead, One is Genuinely Humbled by it.

This response from One's Self,
is an indicator that the
extraordinary has been achieved.

Do not rest,
until the extraordinary
has been achieved.

*Good Intentions.
The single mother of catastrophe.

Good Intentions married to Wisdom,
offers much better chance for success.*

CREATIVE FIRE

Creativity is not Developed
when Needs are Absent
and Riches Plentiful.

Creativity is Compelled
when Necessity is Immediate
and Resources Limited.

As nothing Inspires Creativity better,
than the Angst of a Question,
Burning for an Answer.

With the Greater the Heat withstood,
bearing more Profoundly Insightful Solutions.

EXCEEDING THE STANDARD

When a New Standard has been set,
Strive to Reach it and Exceed it.

Do not Copy it, or be Resentful of it.

But instead, allow Inspiration from it.

HMM, STYLE OR SUBSTANCE?

Just like Form follows Function
in competent Product Design.

Style should follow Substance
in worthy Creative Expression.

However, Substance alone makes
for an Unappetising Experience.

While Style alone leaves a
Hollow and Empty After-Taste.

SUBSTANCE, WITH STYLE

Substance need only to be
enhanced with Style.
Simple, Elegant
and often Discrete.

Style lacking Substance
has nothing for support.
Exorbitant, Excessive
and garishly Replete.

Given absence of both
lacks intrigue or fun.
Bland, Insipid
and best to Delete.

CREATIVE EXPRESSION

The key to truly exceptional
Creative Expression,
is revising and refining,
pushing the boundaries of
understanding and possibility.

With a methodical eye for consistent
attention to detail and precision.

SILENT SEED

A Branch or Tree
crashes and falls
with tremendous
Noise and Violence.

But when a simple Seed
sprouts and grows,
it does so,
in Silence.

GLORIFICATION OF INFORMATION ACCUMULATION

“Knowledge is Power.”

.

No!
Knowing Truth is Power.

There’s a Difference.

.

If there is no accurate Contextual and Meaningful
Understanding of the Information at hand,

then the Information itself is not just useless,
but possibly a distorting hindrance.

*When I am working on a Problem,
I never think about Beauty.*

*But when I have finished,
if the Solution is not Beautiful,
I know it is wrong.*

R. Buckminster Fuller

CREATION

The Pinnacle of Creative Expression,
is the ability to incorporate the most
Complex Functions into the Simplest Form.

Giving rise to an exceptionally
Beautiful and Elegant Solution.



A BEAUTIFUL ACHING

FISH OF THE OCEAN

If One were to explain to a fish
of all that exists beyond the Ocean,
then the fish could retort,

“What is this you speak of?”

*

“I know not of such things.”

*

“Are you a deceiver?”

*

*“Are you here simply
to mock and ridicule?”*

Indeed, if the fish were the type
that swam the great depths,
then the fish may yet query,

“What even is this, “Ocean”?”

For the fish to Understand the Ocean,
the fish must venture beyond the Ocean.

For the fish to Know the Ocean,
the fish would need to Know
what is Not the Ocean.

Only then, can a concept
and a context
for the Ocean develop.

If the fish cannot distinguish
between Ocean and Not Ocean,
then the fish does not Know, the Ocean.

*

It is within this framework that Ideology and Religion are able to control and manipulate.

When all One knows is Ideology and Religion, then One cannot have any concept or context for that which is beyond Ideology and Religion.

In fact, they may even reply,

*“I do not subscribe
to Ideology or Religion.”*

IDEOLOGICAL IDENTIFICATION

The insidious power of Ideology over the Individual is in the deeply ingrained perception that the Ideology is the Individual and the Individual is the Ideology.

This occurs to such a degree, that to mock, or even criticise the Ideology, is seen as an attack on the Individual themselves.

Indoctrination can reach such perverse levels, that some will willingly commit murder, rape and pillage, along with other heinously atrocious acts, all in the name of Ideology.

*It is easy to identify
Ideological Indoctrination
in Another.*

*But is One willing
and able to identify it,
within themselves?*

TRUE IDENTITY

Different Indoctrination Systems
often compete for dominance
in controlling the Individual.

Ideological Systems will push against
Religious Systems will push against
Political Systems will push against
Nationalistic Systems...

But make no mistake,
ALL are Collective Systems,
ALL are Indoctrination Systems,
ALL exist to Obscure True Identity.

Instead, strip back
ALL the illusions,
ALL the facades,
ALL the superficial identifiers.

What then remains,
IS
True Identity.

A BEAUTIFUL ACHING



A BEAUTIFUL ACHING

VIRTUOSITIES!

TRY THE ALL NEW, VIRTUOSITIES!™

Advertisement

Virtuosities!™

**Superficially Appealing,
Fleetingly Tasty Balls**

A hollow vacuous heart is entrapped by a thick brittle layer of self-righteous narcissism.

Preciously wrapped in a thin crisp shell of sweet creamy magnanimous virtue, which melts in the mouth and disappears quicker than you can say, *“What was that?”*

Marvel at how the initial simplistic flavour gives way to a rancidly insufferable after-taste.

Mmmmm!

This exquisite combination ultimately climaxes in a euphoria of spasmodic dry heaving.

Proven scientifically* to stimulate the ability to identify new victim groups everywhere.

Sure to be a hit amongst ideologues and activists the world over.

Impress your friends. Confuse your pets.

See how many Virtuosities!™ you can stuff in your mouth before gagging.

A BEAUTIFUL ACHING

Hurry, get yours now at your local Movie Studio, Mainstream Media Outlet, University Gender Studies Department or Snake Oil Salesman.

Virtuosities!TM

Eat'm By The Sack Full

MANUFACTURED BY W.E.F. FOODS LTD.
A SUBSIDIARY OF THE BOLLOCKS'R'US PHARMACEUTICAL CORPORATION
YOUR TRUSTED SOURCE FOR MEDICALLY DUBIOUS SUBSTANCES

* Scientific proof may not actually exist.

#Virtuosities!

*The inability for One
to laugh at themselves,
is the Anchor of the Heart.*

TRY THE ALL NEW, VIRTUOSITIES!™

Advertisement

Virtuosities!™

**Superficially Appealing,
Fleetingly Tasty Balls**

A hollow vacuous heart is entrapped by a thick brittle layer of self-righteous narcissism.

Preciously wrapped in a thin crisp shell of sweet creamy magnanimous virtue, which melts in the mouth and disappears quicker than you can say, "*What was that?*".

Marvel at how the initial simplistic flavour gives way to a rancidly insufferable after-taste.

Mmmmm!

This exquisite combination ultimately climaxes in a euphoria of spasmodic dry heaving.

Proven scientifically* to stimulate the ability to identify new victim groups everywhere.

Sure to be a hit amongst ideologues and activists the world over.

Impress your friends. Confuse your pets.

See how many Virtuosities!™ you can stuff in your mouth before gagging.

Hurry, get yours now at your local Movie Studio, Mainstream Media Outlet, University Gender Studies Department or Snake Oil Salesman.

Virtuosities!™

Eat'm By The Sack Full

MANUFACTURED BY W.E.F. FOODS LTD.

A SUBSIDIARY OF THE BOLLOCKS'R'US PHARMACEUTICAL CORPORATION
YOUR TRUSTED SOURCE FOR MEDICALLY DUBIOUS SUBSTANCES

* Scientific proof may not actually exist.

#Virtuosities!

abeautifulaching.com

Flyer Image

A BEAUTIFUL ACHING



A BEAUTIFUL ACHING

CONFUSING VERBS WITH NOUNS

Very often, One may confuse a role they fulfil with identification as that role.

For example, Being a Mother or Being a Father is a role that is fulfilled, but there is a profound difference with strongly and solely identifying as A Mother or as A Father. For these are superficial identifiers.

The importance of the role should not be dismissed and superficial identifiers serve a purpose. There simply need be a clear Awareness and distinction between the role and the Individual.

This distinction can even extend to Being a Woman or Being a Man. Rather than foundationally identifying as A Woman or as A Man.

To explicitly clarify for these particular examples, a gender role is not something an ego in a shallow Awareness state gets to choose. A psychologically and emotionally healthy biological Female is enacting Female roles. A psychologically and emotionally healthy biological Male is enacting Male roles.

The Individual though, is never a role.

The Individual is the Pre-Eminent Noun.

It could even be considered, that there is only one noun and that noun, is the Individual. Given the Individual is an Indivisible Duality; the manifest essence of Singularity.

All things are an expression of Singularity. So Singularity is Being a tree, Singularity is Being a chair, Singularity is Being a dog.

However, "*Being*" an Individual makes no sense, since all Human expression originates from the Individual.

A BEAUTIFUL ACHING

Therefore, One cannot “*Be*” an Individual.

One **IS** an Individual.

Problems come about when Foundational Identity is attached to some superficial characteristic or a role enacted.

Considering all of this, there may be deeply pertinent and intentional reasoning behind the term, “*Human Being*”.

*Errors are compounded and magnified
the further Awareness moves away
from the source of the Error.*

*With this being especially True,
for Errors in Understanding.*



A BEAUTIFUL ACHING

DEFINING SPIRITUALITY

The term, “*Spirituality*”, has so far not been used at all, in any of the writings presented on [A Beautiful Aching](#) and this is for good reason.

With that reason being,

“What does it mean?”

What is a definition for “*Spirituality*” that is substantive and meaningful, but does not venture off into religious ideology, vague intangibles and judgements of “*Good*” or “*Bad*”?

To satisfactorily define what is “*Spirituality*”, is to define what is not “*Spirituality*”, by process of exclusion.

But it can be argued that ALL is Spiritual, so what then does “*Spirituality*” even mean.

Rather than “*Spirituality*” being defined in terms of ideological preference or state of personal Self-Awareness, this definition offered below is instead a state of acknowledgement.

SPIRITUALITY

*The Fundamental Recognition
of the Immaterial Foundation
of Material Reality.*

THE UNLEARNING

*Knowing Truth, does not require
an Indoctrination process.*

*Knowing Truth, requires
an Unindoctrination process.*

The process of discovering Truth, or Conscious Awakening, is not necessarily about acquiring more information or learning new skills.

It is primarily about Unlearning nonsense; clarifying Oneself from the mountain of excrement that One believes to be true.

Thus, from this state of Clarity, Truth has a clear and unhindered path for both Expression and Reception.

*To gain all One actually IS,
One only need sacrifice
the ego and all One thinks they are.*

*On balance, a laughably
cheap price indeed.*

THE BELIEF SYSTEM

Ego creates
the “*Belief System*”,
in a futile attempt
to validate itself.

Because even ego
needs some foundation.

But just like
the “*Belief System*”
is an illusion,
the ego
is also an illusion.

Consciousness
does not require
a “*Belief System*”.

In fact, Consciousness
is way beyond reach,
whilst grasping
a “*Belief System*”.



A BEAUTIFUL ACHING

THE DISASSOCIATION OF SOVEREIGNTY

What is being referred to in the title of this verse, is the Disassociation of Sovereignty from the Individual.

If a computer operating system is infected with Malware which attempts to seize control of said computer, then the legitimate user/operator would have difficulty utilising the computer for their own purpose.

If the Human Psyche is injected with Psychological Malware which attempts to seize control of the Human Psycho-Biological Organism, then the Legitimate Authority would have difficulty utilising the Human Psycho-Biological Organism for its own purpose.

The verses, [Crash The Algorithm, Part Two](#) and [The Direction Of Resolving Conflict](#), discuss how unresolved trauma is compartmentalised, resulting in Awareness being pushed further out toward the boundary of Human experience, away from the source of Human expression.

As a product of this shallow state of Awareness, a vulnerability is created, allowing opportunity to insert Psychological Malware into the Human Psyche without detection. Establishing the possibility for interference with Legitimate signalling from the Sovereign Authority, which is the Soul itself, as seen in the hierarchy of [Anatomy Of The Human Being](#) and [The Human Consciousness Model](#).

Once this breach has occurred, it becomes problematic for Awareness to distinguish between signalling from the Soul and signalling from the Malware, since both appear to originate through appropriate avenues behind the Awareness state. Doubt and uncertainty will obviously arise as disparate messaging arrives through these influencing channels.

A BEAUTIFUL ACHING

Complicating the situation even further, upon success of the initial breach, a doorway is opened allowing manipulation vectors to penetrate from all directions. Signal traffic may in turn congest and conflict to the point that it suppresses the Legitimate Source, while also potentially overwhelming the Human Psyche as a consequence.

Employing ideological indoctrination techniques to take advantage of this violation, influences perception and behaviour of the affected Individual. Religious, Political, Nationalistic or any other collectivist agenda, can then be served through the unscrupulous utilisation of the numbers game.

On top of all this, Psychological Malware not only provides opportunity for exploitation, but additionally creates distortions and corruptions within Legitimate coding of the Psyche. Which causes warped perceptions of Reality, preceding abhorrent behaviours, separate from the manipulation aspect.

Adding yet another contributing factor to this already convoluted mess, is that the Psyche is constantly engaged in the process of self-repair. Venturing to undo and heal these unwanted intrusions, whilst having to contend with an ego resistant to any real hardship. As hardship is inevitable in such a circumstance.

Furthermore, Psychological Malware can and will use the ego as a defensive strategy to protect from exposure and rejection.

All in all, rather than creating a method of reliable control, what eventuates is an erratic and chaotic predicament perpetuating from generation to generation, as the initial intervention entrenches itself deeper into the Human Psyche, making way for ever more penetrating incursions.

So, the question at the forefront of this assessment is,

“What is the initial intervention that has set up exploitation pathways for the Human Psycho-Biological Organism?”

The answer is, insertion of malicious code within the Human Psyche compelling it toward obedience and subservience to an exogenous source. Instituting the mechanism for the Disassociation of Sovereignty from the Individual and thus, a forced abdication from Self-Authority.

Worshipping gods and expecting saviours is the primary outcome of this Disassociation of Sovereignty.

Difficulties transpire as this is an unstable situation, with the afflicted Psyche attempting corrections, while contributing efforts come from Nature to facilitate the healing process.

It seems rather ironic here, to have religions that worship deities quick to condemn any abhorrent behaviours, since the basis of their existence is the source of the abhorrent behaviours. The sooner these psychologically parasitic ideas are exorcised from the Human Psyche, the better it will be for Humanity as a whole.

God is the Fallen One.

To close out this analysis, an Individual's level of Awareness sets the Contextual Foundation for their perception of Reality. Having a superficial or incorrect Contextual Foundation, causes a multitude of cascading effects bringing unintended consequences.

Add to that, extrinsic, pernicious Psychological coding which endeavours to override Legitimate Authority and results are predictably, unpredictable.

Despite the tremendous underlying calamity, it must be acknowledged at this point, how phenomenally impressive the Human Psycho-Biological Organism is. Being able to function at all in this severely disconnected Awareness state and under such staggeringly volatile conditions, is truly a testament.

Every conceivable effort and action has been made to capitulate the Human Psycho-Biological Organism, to subdue it into total subservience to an external authority. Every dirty trick, every manipulation, every trajectory of attack has been undertaken.

Yet, the Human Psycho-Biological Organism has not been broken and cannot be broken.

All attempts have failed.

A BEAUTIFUL ACHING

This Earth Human species has shown itself to be Resilient beyond possibility; Robust unworthy of expectation.

The only thing left now, is for Awareness to come back home.

*A Strong Individual
will put themselves in
difficulty and disadvantage
for the benefit of Others.*

*But a Strong Individual
will not abdicate Sovereignty
for the appeasement of Others.*

TRUE TREASURES

Who is to blame?

At whom is vengeance
to be directed?

No One.

True Treasures
are discovered in
the Difficulty,
the Struggle,
the Suffering.

True Treasures like
Perseverance,

Diligence,
Resilience.

Leading to an Unwavering
Robustness and Vitality.

When the value of
these Treasures is realised,
there is no blame to be cast
or vengeance to be had.

The Understanding
that is gained from all of this,
holds only Sincere and Genuine
Gratitude.

*Being Grateful for the
Joy and Pleasant aspects
of One's life is easy.*

*Being Grateful for the
Pain and Difficulty,
takes Real Character.*

DEFINITIONS

Individual – An observational point of reference for Singularity.
(A refinement of the definition given in the verse, [Dualistic Counterparts](#))

Individual Sovereignty – The Individual is ultimately in charge of and responsible for Oneself and One's actions.

A BEAUTIFUL ACHING

This, by extension, includes the benefits and consequences that emanate from such a state.



A BEAUTIFUL ACHING

TYRANNY CHEERS

Tyranny Cheers.
As it plans the construction
of its own gallows.

Tyranny Cheers.
As it gathers resources
and sets them aside.

Tyranny Cheers.
As it enlists willing recruits
to assist in the making.

Ever so diligent
in every regard.

Tyranny Cheers.
As it builds up on high
from foundation to steeple.

Tyranny Cheers.
As it forms suitable rope
for the finishing act.

Tyranny Cheers.
As it ascends the great stairs
and on to the platform.

Victoriously saluting
the assembled honour-guard.

Tyranny Cheers.
As it places the noose
around its own neck.

Tyranny Cheers.
As it hails the crowd
and revels in triumph.

Tyranny Cheers.
As bemused onlookers ponder
and wonder the purpose.

Scratching their heads
whilst speculating why.

.

Tyranny Cheers.

For one last time.

Before taking the leap
and hanging itself.

Then finally realising
what it has done.

...

So to answer the question,

“How is Tyranny Defeated?”

.

There is no need.

For Tyranny is gracious
and delighted to oblige.

**When Moral Integrity
Resolves To Stand Firm.**

*Being Fearless
requires no Courage.*

*Being Fearless
Transcends Courage.*

NECESSARY TURMOIL

Tyranny does not relinquish
power willingly or easily.

Turmoil is not only a given,
but a welcome necessity.

Turmoil destabilises
systems and structures.

Turmoil arouses the
sleeping and apathetic.

Tyranny itself,
will result in Turmoil.

Moral Integrity,
just needs to Hold Strong.

*One that Seeks to be
a Hero or a Saviour,
is a Tyrant in the making.*

UNDERSTANDING EVIL

While One is afraid of Evil,
One may feel compelled to destroy Evil
and in the process, likely become Evil.

Once One is no longer afraid of Evil,
then there is no longer a compulsion
to destroy Evil.

Simply disengage and observe Evil,
allowing Evil to consume itself.

.

Evil is a compulsive parasite
and without a compliant host,
it is left with no other option,
but to feed on itself.

Order of Operations Matters.

Tom Luongo



A BEAUTIFUL ACHING

HUMAN NATURE? WHOSE HUMAN NATURE?

What is archetypal, *"Human Nature"*?

What are the characteristics that are common to all Human Beings?

Is being Compassionate, *"Human Nature"*?

Is being Spiteful, *"Human Nature"*?

Is being Principled, *"Human Nature"*?

Is being Corrupt, *"Human Nature"*?

Is being Generous, *"Human Nature"*?

Is being Greedy, *"Human Nature"*?

Is being Peaceful, *"Human Nature"*?

Is being Violent, *"Human Nature"*?

Is being Obese or Intoxicated, *"Human Nature"*?

Is endeavouring to be Healthy and Vibrant, *"Human Nature"*?

Is considering Individuals, Sovereign, *"Human Nature"*?

Is engaging in Human trafficking, *"Human Nature"*?

Is being Protective of Children, *"Human Nature"*?

Is Molesting Children, *"Human Nature"*?

A BEAUTIFUL ACHING

Which of these are “*Human Nature*” and which are not?

Or, is it more a case of expressing characteristics from a Healthy Psychological state, rather than an Unhealthy Psychological state?

Genuine behaviours of a Psychologically Healthy Individual are extremely different to that of an Individual of severe Psychological derangement. Yet, both are to be considered as conveying “*Human Nature*”?

Throwing around blanket terms like “*Human Nature*”, to define and justify Individual characteristics for a broader Humanity, simply displays ignorance disguised as understanding.

For the most part, the term “*Human Nature*” has no place when defining and discussing Individual behaviours and characteristics out of context. Especial behaviours that Psychologically Healthy Individuals would consider abhorrent.

The term “*Human Nature*”, has meaning when discussing a Psychologically Healthy Human Individual.

“*Human Nature*”, has no meaning in reference to insanity.

It is not surprising then, to find a direct correlation between Psychological Health and Morality.

A Psychologically Unhealthy Individual can never be Truly Moral, no matter how much Religion they immerse themselves within.

In fact, it may be the case that a Psychologically Unhealthy Individual will seek out Religion, as an attempt to grasp at a perceived Morality.

This signifies that the Psyche is at least attempting to find a sound Contextual Foundation from which to build.

*Wisdom will never win
a popularity contest
in a Lunatic Asylum.*



A BEAUTIFUL ACHING

PERCEPTIONS AND REALITIES

*Clarity is the ability
to see, What IS.*

*Philosophy is blindly
guessing at what might be.*

Perception itself does not create Reality.

But the Actions that result from Perception, do.

If Perception is founded on Truth and Clarity, then Truthful Actions result and a Truthful Reality is created.

If Perception is distorted away from Truth, then the Actions taken do not represent actual Reality and thus create a distortion of Reality.

- Which feeds back to Perception.
- That initiates additional false Actions.
- Creating a further distortion of Reality.
- Which feeds back to Perception...

What a Mess.

False Perception leads to False Reality.

Which leads to the eventual destruction of that False Reality.

Because that False Reality, is not Real.

THE FALSE REALITY FEEDBACK LOOP

When Errors are continually being
fed back into a system and not corrected,
then those Errors will eventually
overload the system and crash the system.

Because Errors will not be allowed
to persist or spread indefinitely.

*Truthful Perception
naturally leads to
Truthful Action.*

*Clarity has no need for
centralised autocratic control
to mobilise activity.*

FALSE FOUNDATIONS

If the perceived foundation of One's existence is based on a Lie,
then everything built on top of that foundation is a Lie.

Because Truth cannot be supported by False Foundations.

.

A sprinkling of Truth is required as bait for the Lie.
But too much Truth will overload and collapse the Lie.

SENTIENCE

Consciousness does not
calculate equations.

A Machine that processes an Algorithm,
calculates equations.

Sentience requires
a sufficient level of Consciousness.

An Algorithmic Process
that is calculating equations,
no matter how complex,
can never be Sentient
based on processing capacity alone.

The Universal Machine
and the Natural Algorithm
are born of Consciousness.

Consciousness is not born
from any Machine or Algorithm.

Sentience is not
a glorified Algorithmic Process.

.

**Consciousness requires
no Machine or Algorithm
to be Conscious.**

DEFINITIONS

Sentience – The Capacity for Self-Awareness. The Capacity for Self-Reflection.

Simply being Aware of Physical and Emotional sensation is not Self-Awareness. Being Aware of the One that is Aware of Physical and Emotional sensation, is Self-Awareness.

(Supplemental to the definition given in the verse [Soul Consciousness](#).)

ARTIFICIAL UNINTELLIGENCE

So called, “*Artificial Intelligence*”,
cannot determine Truth.

Only Sentient Intelligence
is able to determine Truth.

Therefore,
what part of “*Artificial Intelligence*”,
is actually Intelligent?

...

ARTIFICIAL INTELLIGENCE

How One becomes
Lazier and Dumber,
even Quicker.

Or

How to produce copious amounts of
Mediocre, Mundane Dross
ever more quickly and efficiently.

.

Because that is what
this world needs more of.

...

SENTIENT INTELLIGENCE

The Capacity to determine Truth.

.

The Capacity to determine Truth
requires the potential to Transcend,
Division by Zero.

...

A more appropriate term for
“Artificial Intelligence”
would be, Algorithmic Generation.

.

At what point does a Tool
become a Hindrance or yet,
Cultivates Dependency?

WHAT IS, IS

There is no need to believe,
speculate, postulate, hypothesise,
theorise, calculate or compute,
What IS.

What IS, IS.

Either One Sees
and Accepts What IS,
or One does not.

Simple as that.

FALLIBILITY OF HINDSIGHT

Hindsight is not necessarily 20/20.

Taking a certain course of Action, brings with it its own Supporting and Opposing forces, which will lead to a particular Outcome.

Taking a different course of Action, brings Supporting and Opposing forces which may be quite unlike the first course of Action, leading to another Outcome.

The balance and makeup of Supporting and Opposing forces will vary depending on the course of Action taken.

The point here being, is that Hindsight may not take into account differences in balance and makeup of Supporting and Opposing forces for an alternate course of Action.

Additionally, some of these forces may only make themselves known when a specific course of Action is instigated.

The reliability of Hindsight as a means to evaluate Actions and Outcomes should always be tempered, given its limitations to foresee variabilities in prevailing forces.

*Truth can be approached
from Infinite directions
and it will always be Truth.*

RESPONDING TO TRUTH

When One Sees and Accepts Truth,
One can then Respond to Truth.

If One does not See or Accept Truth,
then One cannot Respond to Truth.

.

When One Believes in Lies,
One then Reacts to Lies.

Seeing Truth, requires Awareness.

Belief, is a programmed condition.

ZOMBIE LA LA LAND

Those that have their *"Reality"* shaped by
Television and Corporate/Government Media,
are living in a Zombie La La Land.

.

The primary responsibility for this,
is not with these corrupt institutions,
but with the Zombies that buy into them.

NOT YOUR INTERESTS

When it comes down to it,
Corporate and Government Media
are simply mouth pieces for
Corporate and Government Interests.

Not really surprising or unexpected.

.

In other words,

Not Your Interests.

PSYCHOLOGICAL CONTAMINATION

Believing in Lies and Untruths
Contaminates the Psyche.

The Deeper the Belief
the Deeper the Contamination.

.

Belief itself is a
Psychological Contaminant.



A BEAUTIFUL ACHING

G GOD IS DEAD!

God Is Dead!

You Killed God!

.

No! He was dead when I got here.

I'm just pointing out the carcass.

OBITUARY

You taught us a lot,
from which we have gained.
But it's time to move on,
in this world that you reigned.

Your body long dead.
Was it ever alive?
I'm sure we will manage,
and possibly thrive.

In dreams and in stories,
did you only exist.
So good-bye and farewell.
Will you even be missed?

*You claim that you didn't kill God.
But you sure did fire a lot of bullets at him?*

*Hey, I fired bullets into the corpse
to see if it was alive.*

*And since it didn't react to being shot,
it must have already been dead.*

WHY TERMS MATTER

The term “*Singularity*”, encapsulates the very essence of what the word is referring to and describing. It has meaning that is not bound to religion, because the Universe itself is not religious.

The term “*God*”, offers nothing as an insight to the True Nature of the Universe, it describes nothing of the Universe. It only has religious connotations, because religion wants all to consider Religion to be at the centre of the Universe.

Which is just not True.

Religion also requires the Individual to Subordinate their Sovereignty to this idea of “*God*”, which then opens up vectors for corruption of the Individual, because there is no “*God*” to be Subordinate to.

The very act of Subordinating Sovereignty is the initiating corruption of the Psyche.

THE OTHER SIDE OF HELL

Where is this *“God”*
when One is experiencing
their own personal Inner Hell?

.

The Answer is found,
when One makes it through
to the other side of Hell.

One then discovers,
there was never any *“God”*
to begin with.



A BEAUTIFUL ACHING

KNOWING INFINITY

This verse is presented as a way to conceptually Understand Foundational Structure. It is not an actual description of the beginning of the Universe, for there is no Beginning or Ending to the Universe.

The processes and functions of Creation are highly interconnected in complexity and cannot be adequately described in a short summation. But a general overview can be presented, which may then offer an invitation for further exploration.

*Maybe if One Said Less,
One might come to
Understand More.*

Singularity/Consciousness cannot perceive of itself in its fundamental state of Nothingness, because of its Infinite nature.

Meaning, that it has no Boundary, therefore no Form, from which to make any meaningful and substantial evaluations.

Infinity cannot Know Infinity, since Infinity has no way to Understand Infinity. (Division By (0))

For Understanding and Knowing to occur, Form is required for Consciousness to Reflect on to and off of, back to Consciousness.

- Boundaries create Form.
- Vibration creates Boundaries.

A BEAUTIFUL ACHING

- Hence Form is the result of Vibration.
- Different Forms are the result of changes and variations in Vibration.
- All Vibration is based on digital frequency, or pulsation. Reason being, is that the only thing Singularity has at its disposal, is itself and its Indivisible nature. It is Nothing (0) and it is Everything (1). It only has, Duality.

“But how is this Vibration initiated?”

It is initiated from a Force that induces Resonance. However, this Resonance not only occurs from a singular point source, but from every point source, as Singularity is again, Nothing and Everything.

Certain aspects that arise from the resulting complexity are,

- Interference patterns between Resonance waves.
- Variations of Frequency, Amplitude and Wavelength create differing densities and transitions between boundary states.
- Higher Frequency Resonance creates more responsive waveforms.
- Higher Amplitude Resonance creates more impactful waveforms.
- Shorter Wavelengths create denser, more compact waveforms.
- Node points where Resonance waves intersect become so dense, that what is known as *“Matter”* is formed.

All this has a compounding and layering effect, which eventuates into the Fractal Nature of the Universe.

“How does the Force come about to induce the Resonance?”

The Force comes about from the Desire, the Longing, the Love, to Understand.

This is, The Question Mark (?).

The Question Mark (?), is the Force.



THE QUESTION HEART
FROM QUESTION MARK TO QUESTION HEART

The Question Mark (?) does not ask anything specific, but it is the initiating impetus that leads to the specific question.

The Question Mark (?) represents the driving force behind the Universe.

The makeup of Singularity,

- Universal Origin (0)
- Universal Whole (1)
- Everything in between (?)

(0) – (?) – (1) : ∞

EXPANDING INTO WHAT?

An Infinite Universe
is not Expanding.

How can Infinity Expand
to be more than it already is?

.

A Primary Verse of Galaxies
may exhibit rhythmic
Expansion and Contraction,
similar to breathing.

But this is not,
Infinity Expanding.

RESOLVING THE NOISE

Inner Silence, Stillness
is not Created.

Inner Silence, Stillness
is the result of
Resolving the Noise.

.

Resolving the Noise implies,
Allowing it and Observing it,
until it fully plays itself out.

Leaving nothing left,
but Silence, Stillness.

CONTENT AND AT PEACE

If One is Content and At Peace being Poor,
then having wealth is simply a Bonus.

If One is Content and At Peace being Alone,
then Another by One's side is a welcome Bonus.

If One is Content and At Peace being a Nobody,
then being well known and loved is a pleasant Bonus.

.

But if being Content and At Peace relies on Bonuses,
then those Bonuses will only magnify the shortfall.



A BEAUTIFUL ACHING



CLOCK FREQUENCIES OF THE SUN

A Central Processing Unit (CPU) within a computer system has the ability to generate what is known as a, “*Clock Frequency*”.

This Clock Frequency produces pulsations that are necessary to regulate computational processes and sequences of the CPU.

If the Clock Frequency is erratic in its output or interfered with, then all manner of errors may result, culminating in the eventual possibility of hardware failure.

Included in the many functions and outputs of the Sun, is the generation and expression of a multitude of Clock Frequencies. These serve to regulate and coordinate operations within the entire Solar System, including Life on Earth.

Biological processes such as photosynthesis and vitamin D production, have dependencies on Solar Clock Frequencies in the visible light range. But the light spectrum output from the Sun extends way beyond what is visible, as it promotes and governs many Life processes, seen and unseen.

Additionally, Solar expression is a mechanism for information transfer of Life Code, which creates, heals and maintains all forms of Life.

For the Human Psycho-Biological Organism, Sun output is vital for Physical health and well-being. Furthermore, it carries code information required to help repair and heal Emotional and Psychological structures, plus Clock Frequencies to regulate Emotional and Psychological function.

Human Psycho-Biological processes dependent on Solar output can be inhibited and disrupted in several ways,

- Sunglasses – Interfere with unadulterated Sun output entering the eyes.

A BEAUTIFUL ACHING

- Sunscreen – Interferes with the take up of Sun output through skin.
- Electromagnetic Fields (EMF) – mobile phones, computer screens, microwave ovens, electrical smart meters and other technologies, all generate frequencies that may distort or impede Physiological, Emotional and Psychological function.

A cumulative degrading effect can occur from these over time, which could be difficult to trace, with the outcomes then being falsely attributed to other causes.

Direct Sun exposure however, should be limited to optimum levels for the applicable climate and region. As too much, just like too little, can yield adverse effects.

An additional aspect of Solar Clock Frequency that might not be immediately apparent, is the regulation of Time Perception.



A BEAUTIFUL ACHING

G GETTING ONE'S ATTENTION

To the Oblivious and Distracted.

.

When requiring One's attention,
Nature first whispers in the ear.

If this fails to arouse,
Nature speaks a little louder.

Lacking any real response,
Nature gives a gentle nudge.

Not receiving any feedback,
Nature slaps across the head.

**Still not getting required action,
Nature has a 2x4.**

**PAYING ATTENTION YET?
NATURE KNOWS HOW TO DRIVE A BUS.**

DEFINITION

2x4 – A length of lumber with a 2 inch by 4 inch rectangular cross-section.

Read as, 2 by 4. The implication here being, that One will be smacked in the face with it. Metaphorically speaking.

*Nature is not
fundamentally hostile
to Human existence.*

*Nature just needs to Roar
to get Humans to Listen.*





OFFENDED YET?

*Metaphysical Collapse
is the essential precursor to
True Awakening.*

*It is the Doorway Opening,
that Invites the Journey.*

It is of no concern
if One Feels
Stupid or Disrespected.

Because it is not the
Individual or the Soul
that Feels Offended in any way.

It is the Ego!

The reason why
Psychological and Emotional Intensity
must be turned up to 11...

Is to Kill the Ego.

...

A virus has a limited
temperature range
in which it can survive.

This is why part of the
Human immune response
is to induce fever.

FACING DEMONS

When One is Quiet and Alone, away from distraction,
One's Demons start rising to the surface...

.

Face Those Demons.

MISUNDERSTANDING EGO

Arrogance is an aspect of Ego.

But so is Insecurity.

Because Arrogance is a facade
to disguise Insecurity.
Just another extra layer of Ego.

Insecurity is not
the opposite of Arrogance.

Criticism of Arrogance as Ego
and defending Insecurity as not,
comes from the perspective of Ego.

It annoys Ego to be identified as Ego.

Ego is the False Self, the Illusion of Self.

Ego is not based on perceived
Positive or Negative characteristics.

Ego cannot be recognised for what it truly is,
until One is detached from Ego.

INDIVIDUALITY \neq EGOISM

The connection of Individuals through Singularity,
has a far Greater, Deeper and Stronger binding effect,
than a connection of Individuals through
superficial egotistical collectives.

Ego, identifies as a Nationality.

Ego, identifies as a Religion.

Ego, identifies as a Political Grouping.

.

True Individuality \neq Egoism

THE EVASIVE EGO

Ego portrays Individuality
in a disparaging manner.

Since Ego is afraid
of Individuality.

Because Individuality
holds Ego accountable.

Ego, is constantly squirming,
to avoid accountability.

Ego, hides amongst collectives,
to elude responsibility.

Ego, is often projecting,
to denigrate the critical.

.

Such is,
The Evasive Ego.

*It is not only Heartbreaking, but also Angering,
to be able to see the Extraordinary Potential of Humanity
in comparison to its current reality.*

11th February, 2023

SECURITY BLANKETS

PET, ESPECIALLY PET DOG

Biological Security Blanket.

.

An easy token effort at filling
a colossal Emotional void.

As opposed to actually exploring
the colossal Emotional void.

*

SMART PHONE

Electronic Security Blanket.

.

Also functions as a substitute Brain.

When Laziness and Stupidity
render actual Brain function too difficult.

*

GOD

Existential Security Blanket.

.

When Fear of Mortality and the idea
of being Alone in the Universe,
is just too much.

CHALLENGING COMFORT

When One is Comfortable,
One is unlikely to Question.

So to prompt One to Question,
is to make One Uncomfortable.

BE POLITE

Excuse me.

I have a question.

Regarding this demand
you made of me to refer to you
by some retarded pronoun
or degenerate gender.

Um, I was wondering,
if you knew of a polite way to say,
F@#K YOU!?

Because I don't want to be rude,
or anything like that.

ONLY SO MUCH

How much time and effort
must be wasted by the Wise,
trying to convince the Deranged
that they are Deranged?

This time and effort
could better be spent
achieving more
productive outcomes.

It is each Individual's responsibility
to be able to See Truth for themself.

Eventually,
the Wise will conclude,
Enough is Enough.

The Deranged will then,
be left to their own fate.

*It is not my responsibility
to convince you of Truth.*

*The fact that I am making the effort,
means that I do not wish you to fail.*



A BEAUTIFUL ACHING

HUMANITY'S PURPOSE

*There is no impetus to seek Truth,
when a ready-made Lie
is presented as the only option.*

Aspects of Creation that do not satisfy
Nature's Primary Objective,
will eventually be Destroyed.

Promoting and Worshipping
Gods and Deities **does not** satisfy
Nature's Primary Objective.

Decadence, Depravity and Debauchery
also **does not** satisfy
Nature's Primary Objective.

Exploring and Discovering Truth
IS Nature's Primary Objective.

Nature's Primary Objective,
is Humanity's Purpose!

Indoctrination is not Truth.

.

The Clock is Ticking.

*Q. From where did Communism
learn its Indoctrination tricks?*

A. From Religion!

IDEOLOGY ADDICTION

Religious person: Wokeness is like a religion.

Sane Person: You don't say! (Facepalm)

.

Ideology Addiction is very similar to drug addiction.

Addicts find it difficult to admit they have a problem.

Religious Addicts: *We're all Individuals.*

The Heretic: *I'm not.*

Monty Python's Life of Brian

TRADITIONAL INDOCTRINATION

Religion is currently an acceptable form of Indoctrination, primarily because of its traditional longevity. With all meaningful opposition long eradicated or forgotten.

In its favour, Religion at least draws on some level of reality as a foundational hook to lure and maintain followers.

Wokeness is new, with no traditional legacy, opposition still immediate and fierce.

Based on delusion, devoid of reality and victimisation the over-riding mantra. So its followers not only see victim-hood everywhere and create victim-hood, but often consider themselves, The Victim.

IDEOLOGY CANCER

Religious Cancer may be in a slight remission
while the Woke Cancer runs rampant.

But if the Woke Cancer is somewhat tamed,
the Religious Cancer could flare up with a vengeance.

All Cancer must be resolve, permanently.

I BELIEVE

“I Believe in my heart of hearts that “X” is true.”

Translation.

“My programming and ego desperately requires “X” to be true.”

HAND-ME-DOWNS

Ideological Belief is a
Regurgitated Hand-Me-Down.

Discovering Truth requires
Far More of Oneself.

VALIDITY OF OPINION

Opinion, based on
Subjective Personal Preference,
is valid.

Opinion, claiming to be
Objective Truth,
is not.

.

One's Favourite Colour
is an Opinion.

One's Favourite Shirt
is an Opinion.

One's Favourite Book
is an Opinion.

One's Creative Style
may be an Opinion.

.

One recognising
the Favourite Colour of Another
is not an Opinion.

One recognising
the Favourite Shirt of Another
is not an Opinion.

One recognising
the Favourite Book of Another
is not an Opinion.

One recognising
the Creative Style of Another
is not an Opinion.

.

Gravity
is not an Opinion.

The Sun
is not an Opinion.

The Universe
is not an Opinion.

The Self
is not an Opinion.

.

Belief, is an Opinion
claiming to be
Objective Truth.

However,
Objective Truth
is not an Opinion.

AGREED UPON DELUSION

“Why can’t we Agree on Truth?”

.

What?!

Truth is not Agreed upon.

Opinions are Agreed upon.

.

One either **SEES** Truth,
or One does not.

That Is It!

.

Those looking for Agreement,
are looking for Others
to Validate their Opinion,
to Validate their Delusion.

OVERWHELMING CONSENSUS

Truth is not Manufactured
from a Consensus of Opinion.

No matter the Volume
of Consenting Opinion.

THE REAL DIFFICULTY

The Real Difficulty
of not being able to handle Difficulty,
is in not accepting Difficulty.

SAVING HUMANITY

Humanity Does Not Need Saving.

Humanity Needs To Wake Up.

.

Because If Humanity Cannot Wake Up,
Then Humanity Is Not Worth Saving.



A BEAUTIFUL ACHING

HEALTH CARE ≠ MEDICAL AID

*Is poor health the result of
sickness and disease?*

*Or is sickness and disease
the result of poor health?*

An actual Health Care Industry is not possible.

Because a genuine Health Care system would make itself obsolete long before it becomes an industry.

A massive Medical Industrial Complex can only be maintained and sustained if there is a large, constant supply of illness.

Health Care ≠ Medical Aid

*Pharmaceutical companies
pedal the idea that poor health
is the result of the body being
deficient in patented drugs.*

*Blindly placing responsibility for One's health
into the hands of governments and corporations,
invariably leads to the unsurprising
exploitation of One's good faith.*

Medical costs due to accident or misfortune are dwarfed by those for Self-Inflicted or Self-Induced causes.

How much more would be available for the truly needy, if it were not for so many actively destroying their own health through poor diet and lifestyle choices?

There is no need for more hospitals, doctors, nurses or other medical resources.

What is required, is Healthier Individuals.

*Generally speaking, the Human Body
is not inherently prone to illness.*

*The Human Body requires
prolonged serious abuse
to be easily susceptible to illness.*

HEALTH EXPERTS

The average Doctor
is just a legalised version
of a Drug Dealer.

Only not as Rich.

The average Psychologist
is of no greater value
than a Carnival Fortune Teller.

Only more Smugly Condescending.

NOT HEALTH ADVICE

A Doctor is of value if One has sustained an injury that requires medical expertise and intervention to address.

Relying on the average Doctor for Health advice, results in the accumulation of a drug haul that would make a Drug Dealer embarrassed.

DRUG PROFITS

Pharmaceutical Drugs do not
provide One with Good Health.

At best, Pharmaceutical Drugs treat
the symptoms of Poor Health.

.

Curing Poor Health
Cures the Medical Industry
of their Devious Profits.

A BEAUTIFUL ACHING



A BEAUTIFUL ACHING

WRITING FOR MEANING

*The key to Writing for Meaning,
is Clarity.*

THE MEASURE OF WRITING

The Measure of Writing should not be based
on the Volume of Words per Subject,
or how Eloquent and Fanciful the Poetry.

The Measure of Writing should instead be appraised
by the Volume of Meaning successfully conveyed
using Words as Efficiently as Possible.

FOR THE SAKE OF WRITING

Writing for the sake of Writing
is like hitting everything with a Hammer,
simply because One has a Hammer.

.

One is to first consider, is there
anything of Value to express?

THE REFLECTIVENESS OF WORDS

Words are not Powerful.
Words themselves are Reflective.

What Words do, is impart
Sentiments and Ideas.

How those Sentiments and Ideas
are conveyed through Words,
Reflects the Quality and Character
of the Sentient Source from which those
Sentiments and Ideas are expressed.

*An intriguing and effective quotation,
is potent and fertile with meaning,
whilst precise and efficient with language.*

HEROES OF THE EVERYDAY

Fictions of a Super Hero,
whose goal it is to save the world,
are not the most interesting tales.

A compelling depiction of an everybody,
who makes significant strides to save themselves,
is always an inspiringly uplifting story.

*What is most Personal,
is most Universal.*

Carl R. Rogers

MESMERISED BY FANTASY

It is an issue when One is unable
to differentiate between Reality and Fiction.

When creating a Fictitious world,
all the possible contradictions and inconsistencies
of that world, do not have to be addressed.
They can simply be ignored to suit the narrative.

However, with Reality, there is no such luxury.
Because Reality will expose, the error in the Fiction.

INSIGHTFULLY STUPID

A Profoundly Insightful Perspective,
makes One feel Smarter and Stupider
at the same time.

.

Smarter, for the Perspective's Insightfulness.

Stupider, for the Perspective's Obviousness.

A BEAUTIFUL ACHING



A BEAUTIFUL ACHING

MASTER THE MUNDANE

*There are no Menial Tasks,
just Menial Attitudes.*

If you are cleaning dishes,
clean them as though
they are the most precious things
in all of existence.

If you are sweeping floors,
sweep them as though
your life is dependent on
the final result.

If you are shovelling manure,
shovel it as though
the well-being of your children
is very much at stake.

Then on top of all this,
be accepting of the fact,
that the only guarantee,
for all of your endeavours,
is the satisfaction felt,
from giving all you can.

This is,
Mastering the Mundane.

*The path toward being a Great Individual,
is to Master the ability of wading through shit.*

EXTRAORDINARY POSSIBILITIES

One must Master the Mundane
before the Extraordinary will be offered.

One must Master the Mundane
to prove to the Universe
of One's potential ability
in facing the Exceptional.

For why would Creation
waste resources and time
on those that struggle
with even the Banal.

.

Be Master of the Mundane.

MASTERING EMOTION

Mastering Emotion is not achieved
by Repressing or Controlling Emotion.

Mastering Emotion is developed
through Resilience and Stability.

To a point that One is not only able to withstand
Any and All Emotional Intensity,
but Transcends it and becomes transparent to
Any and All Emotional Intensity.

Resulting in, Absolute Clarity.

BEING DETACHED

Feel the Suffering.
Rather than being attached,
to the Suffering.

You are Not the Suffering.

.

Feel the Ecstasy.
Rather than being attached,
to the Ecstasy.

You are Not the Ecstasy.

PROVING CHARACTER

Courtesy is given,
when interaction is casual.

Respect is Earned,
when Character is Proven.

.

A BEAUTIFUL ACHING

Proving Character to Oneself
renders Respect from Others,
Redundant.



A BEAUTIFUL ACHING

C COMMANDING HYPOCRISY

*It is quite often the case,
that the Foolish and Naive
grab a semblance of Truth
and Pervert it into the Absurd.*

The Religious Hypocrisy
of The Ten Commandments.

*“Thou shalt not make
unto thee any graven image.”*

Often interpreted as,

“You shall not make idols of God.”

So making a direct Idol of God is unacceptable,
but implied Religious Idols are fine?

Crucifixes, Statues, Religious Paraphernalia
are all Idols that are acceptable to Religion.

Religion is Idol Worship!

*“Thou shalt not bear false witness
against thy neighbour.”*

Often interpreted as,

“You shall not lie.”

Is it only against thy neighbour
that One is not to Lie?

But what if the idea of a
Santa Claus in the Sky is a Lie?

Then all Religious Individuals
are actively participating in a Lie.

“Believe this Religion and do not Question it.”

“But what if this Religion is a Lie?”

Religion Itself is a Lie!

“Thou shalt not kill.”

Notice, no conditions or
caveats to this statement.

Religious Wars anyone?

Politicians Lie to start Wars.

How many Religious Individuals
support and promote those Lies
to start Wars?

How many Religious Individuals
work in the Industries of War?

"Thou shalt not steal."

Taxation is Theft.

Government is funded
through Taxation.

How many Religious Individuals
work for Governments?

The Religious Individuals
working for Government
are being paid from Theft.

.

Religions do not do a very good job
of being consistent.

Religions Virtue Signal Hypocrisy.

Taxation isn't theft...

It's ARMED ROBBERY!

Viva Frei

MORAL HYPOCRISY

Honesty is considered a virtue,
yet so many perform outstanding feats
of mental gymnastics, to wilfully avoid Truth.

PROPORTIONS OF HYPOCRISY

Hypocrisy is
inversely proportional
to Self-Awareness.

.

When Hypocrisy is at a maximum,
Self-Awareness is at a minimum.

CORRALLING THE EGO

The Process of Awakening could be seen as an operation
of Corralling the Ego into a smaller and smaller space,
thus forcing it to face its own Insecurity and Hypocrisy.

VIRTUOUS COMPLIANCE

The true Wickedness of Religion,
is that it has turned Subordinating and
Abdicating Sovereignty into a Virtue.

.

Being Weak, Feeble and Compliant,
is seen as Virtuous.

*When it comes down to it, Worship
is just a polite way of saying, Grovel.*

FARMING VITALITY

It is much easier for a farmer to milk a cow
when it is calm, comfortable and docile.

It is much easier for Religion and Politics to Extract Vitality
from those that are Oblivious, Distracted and Compliant.

Any Collectivist Ideology is the basis
for Vitality Farming the Soul.

.

Energy Flows to where Attention Goes.

*Religion and Politics
are the Cancer of the Soul.*

TRANSHUMANIST AGENDA

The Transhumanist Agenda
of merging Machines with Humans,
is an attempt to trap Souls within Machines.

A more effective way of Soul Harvesting.

.

Brain Chip Anyone?

GATE KEEPERS OF TRUTH

Evil hijacks an aspect of Truth,
then claims to be
the Source of that Truth.

Whilst deviously
undermining that Truth.

.

Religion hijacks Morality and Virtue,
then claims to be the Source
of Morality and Virtue.

.

Politics hijacks Sovereignty and Authority,
then claims to be the Source
of Sovereignty and Authority.

*It is childish and simplistic to not recognise
that even those that One considers “Evil”,
could still act in ways that may benefit them.*



A BEAUTIFUL ACHING

NORMALISING THE ABNORMAL

If an Individual is born with a Deformed Limb, like an arm or a leg, then that Individual is recognised as having a Deformed Limb.

Such an Individual should be allowed the opportunity to live their life as best they can, freely and peacefully, reciprocated; in whatever way suits them, with or without any help that others may want to provide.

However, the fact that this Individual has a Deformed Limb, should not be Normalised.

It Should Never, Be Normalised.

There is an archetypal standard for Healthy Human Male/Female Physical Form and Function, which is obvious for those that choose to be honest.

When Deformed Limbs start being Normalised, it has the likelihood to entice the Emotionally and Psychologically unstable to go about Deforming their own, otherwise, healthy Limbs.

This, then cascades in to a collective behaviour.

Others will be persuaded or pressured to do the same.

Those that have Deformed Limbs will be inclined to increase their numbers, as an additional method of Normalisation. Leading to this Abnormal behaviour being considered, *“Tolerant”* and *“Inclusive”*.

Young children will be Indoctrinated into believing it to be Normal to have a Deformed Limb.

Young children, not knowing any different, will consequently be encouraged to Deform their own perfectly Health and Functional Limbs, because young children wish to be seen and accepted as Normal.

A BEAUTIFUL ACHING

This whole process also applies to Emotional and Psychological Deformation/Derangement, not just Physical.

Sinister forces will use such techniques to destabilise societies, as resistance comes to this insanity. Hence, leveraging the resulting turmoil into greater political power and control for themselves.

*An Individual of Abnormal Form or Function
should be accepted and treated as any Other.*

*But the Abnormality itself,
should never be Normalised.*

VIRTUOUS EVIL

Wokeness and Identity Politics
strip an Individual of their Humanity
and reduce them to a Superficiality.

.

Wokeness and Identity Politics are Evil.

*Evil often projects itself onto Others,
then condemns them for being Evil.*

DEFINITION OF WOKE

A state of awareness only achieved by those
dumb enough to find injustice in everything,
except their own behaviour.

(Unknown Source)

PROTECTOR OF FEMININITY

Masculinity is the
Protector of Femininity.

The Outer Shell of a seed
is the protector of
the life-giving Inner Core.

The Outer Shell is Masculine.
The Inner Core is Feminine.

The Masculine moves aside when
the Feminine is ready to birth new life.

Attacks on Masculinity
are carried out
to devalue Masculinity.

Attempting to create an
irreconcilable rift between
Masculinity and Femininity.

Thus corrupting both,
Masculinity and Femininity.

A BEAUTIFUL ACHING

All this is done to gain access and control
over the life-giving Essence of the Feminine.

The Feminine, is the true target,
of the attacks on the Masculine.



A BEAUTIFUL ACHING

MISGUIDED SUPER HEROES

*Strength, is not the Measure
of One's Ability to Throw a Punch.*

*Strength, is the Measure
of One's Capacity to Take a Punch.*

The incarnation of the Soul, is a process that provides the experience to Understand as many aspects and facets of Creation as deeply as possible. In order for the Soul to Know itself and in turn, to Know Creation.

This process naturally encompasses a range of Pleasant and Unpleasant experiences, because this is the Nature of a Dualistic Reality.

A storybook Super Hero with exceptional powers, whose purpose is to protect those weaker from Unpleasant experiences, interferes with the Souls journey and development.

This is a crime against the Soul.

This is why storybook Super Heroes do not actually exist.

A sane and moral Individual, will unquestionably assist Others in difficulty as best they can, without storybook Super Powers.

A storybook Super Hero or Saviour, incessantly saving those weaker, is the equivalent of a weak Individual going to a gym, but expecting a stronger Individual to lift the weights for them.

A BEAUTIFUL ACHING

A storybook Super Hero flying halfway around the world to prevent an aircraft from fatal collision, is unduly and unwisely interfering with the Soul experience of all affected Souls.

If every aircraft encountering difficulty was saved by a storybook Super Hero, what Understanding could ever be gained from such situations? Designers, manufactures and operators of aircraft, would have no incentive to improve their product. Because designers, manufactures and operators of aircraft, should do their best to ensure their aircraft do not fail.

Given that, while observing an alien world with a developing species, One was able to foresee a tragedy emerging and had the means to avert it, should One interfere?

Should One interfere in a process that may likely incentivise that species to develop new and unique levels of Understanding?

Interference would rob them of this opportunity.

Interference would simply satiate the ego's desire to play, storybook Super Hero.

Is this not Selfish?

Is it not Selfish to flaunt powers which thwart Others from being motivated into advancing deeper levels of Understanding?

Ideas of a storybook Super Hero are severely misguided.

The True Power, of a real Super Hero, is an unglamorous ability that is potentially available to all.

That Power is, Wisdom.

A TIME FRAME FOR WISDOM

What is, "*Ancient Wisdom*"?

Is there, "*Modern Wisdom*"?

Does Wisdom change
according to the time period?

Or is it rather a case of
True Wisdom, being Timeless.

.

True Wisdom is available
wherever and whenever
One is receptive.

BE PREPARED

However Difficult One imagines the process of Awakening to be, know that this is merely the starting point of the Difficulty and is by no means the maximum level of Difficulty.

For there is no maximum level of Difficulty, One just Transcends being burdened by Difficulty.

Also be Aware, Creation is a Duality and Unpleasantness is eventually balanced with Pleasantness, if One is able to see it through.

*When consistently approaching
the Wrong Conflict in the Wrong way,
is it any wonder that the Real Conflict,
is never resolved?*

PAIN AND TORMENT

To those experiencing
seemingly endless
Pain and Torment.

Every morning
when you wake up,
promise yourself
to go to bed that night.

Continue this,
each and every day.

WET FEET

So, you want to complain about Difficulty, when you have barely gotten your feet wet?

How about, you swim out into the deepest part of the Ocean, while enduring some of the most extreme and vicious storms that Nature can throw at you and then, allow your ego to drown in that Ocean?

After that, come back to me and talk about Difficulty.

THE CONFIDENCE TRICK

“I struggle with Confidence.”

.

So?

What does Confidence
have to do with Competence?

What does Confidence
have to do with Courage?

What does Confidence
have to do with Integrity?

What does Confidence
have to do with Morality?

What does Confidence
have to do with Awareness?

What does Confidence
have to do with Truth?

.

Confidence is a contrived mask,
to hide deficiencies in real substance.

INDIVIDUAL QUALITY

Low Quality Individuals
compel Collectivism.

High Quality Individuals
encourage Individuality.

Low Quality Individuals
seek to feed off
High Quality Individuals.

High Quality Individuals,
understand the game.



A BEAUTIFUL ACHING

DIRECTIONS TO FIND GOD

Okay, first, turn Inward,
then take the third path on the right.

Follow this path to the end,
until you get to the Gates of Hell.

These are never locked,
so just walk straight in.

Here is where things become tricky.

Hell is a bit of a maze and establishing
a sense of direction is problematic.

However, perseverance pays off
and it eventually becomes apparent,
that whichever direction you take,
it will always be down.

But go with it.

Oh..., I forgot to mention,
after walking through the Gates of Hell,
they lock behind you.

Oops!

Managing to make it down
into the Bowels of Hell is a big plus,
just be sure to re-hydrate often,
as it can get quite toasty in there.

Also, best prepare for a long stay,
since finding the way out
is not all that obvious.

Supposing, by chance, you do find the way out,
dragging yourself by the fingernails
up an Almost Vertical Endless Cliff-Face
is the easiest route.

Do not try the other options,
as these go on, meandering forever,
circling back to where you started.

Don't ask me how I know.

Good for you,
should you make it to the top of
the Almost Vertical Endless Cliff-Face.

Here, you will find yourself on a ledge,
just wide enough to stand on tippy-toes.

Which really only leaves you with two choices.

Either, you slide back into the Bowels of Hell,
or you leap off, surrender to the Infinite Void
and see what happens.

A little hint,
picking the Infinite Void will pretty much
destroy everything you think you are.

So..., there's that.

Be sure to choose wisely.

If you opt for the Infinite Void,
you are now the Infinite Void.

Well, the problem at this point is,
Um...,
presuming it was God you were looking for,
it may be disappointing to realise that,
Um...,
he's just not here.

Sorry?

.

Sorry for informing you that
YOU,
YOURSELF,
are Infinite Consciousness!

*Being a Sovereign Individual means,
that if One chooses to be a Fool,
then One gets to be a Fool.*

THE UNSPOKEN RULE

*"Don't poke my Delusions and
I won't poke your Delusions."*

.

Poke Every Delusion!

IMAGINING INFINITY

Thoughts, Imagination, Ideas.

These are not the Source of Consciousness.

These are a Product of Consciousness.

These are Downstream of Consciousness.

.

Thoughts, Imagination, Ideas.

Although not considered Material,
are still based on Boundaries and Form.

How does One then Imagine,
the Precursor to all Boundaries and Form?

.

Infinity/Consciousness is the Precursor
to all Boundaries and Form.

So therefore, cannot be Imagined.

CHICKEN OR THE EGG

Q. Which came first,
God or Religion?

A. Religion.

.

Religion created the idea of God
so as to be able to parade
as the representative of God.

Because if God came before Religion
and was fine existing prior to Religion...

Why then create Religion?

What is the point
of having inconsequential plebs,
worshipping the
"Creator of the Universe"?

.

The Cake is a Lie.

PRETENDERS AND FRAUDS

A Truly Moral Individual of Integrity,
can dispense with the Church,
can dispense with Religion
and still be,
A Truly Moral Individual of Integrity.

.

Pretenders and Frauds
require the Church,
require Religion
to Validate their Facade
of Morality and Integrity.

AN ENLIGHTENING DISCUSSION

Religious Person: I believe in a God that lives at the bottom of the ocean.

Singularity: Well, why don't you leave the safe comfort of the shoreline, swim out into the middle of the ocean and find out for sure?

Religious Person: Oh, I can't do that. The shoreline is safe and comfortable. Besides, I have put so much time and effort into cultivating my belief, that my whole identity and life, now revolve around it. Could you imagine how devastating it would be if I realised, I was wrong?

Singularity: So, you refuse to find out for sure, because you're afraid of being wrong?

Religious Person: Well no, not just that. Swimming out into the middle of the ocean is hard. There's sharks and storms and many other dangerous things.

Singularity: So, you refuse to find out for sure, because you're afraid of being wrong and it's hard?

Religious Person: When you say it like that, it makes me sound like a wilfully ignorant coward.

Singularity: If it quacks like a duck...

Religious Person: No, No, No. Thank you for the discussion, but I am quite happy just standing on the shoreline, believing in my God that lives at the bottom of the ocean.

Singularity: Hmm, maybe I should send a Tsunami your way?

THE BIBLE

Accurate Interpretation and Translation
of Original Source Documents is Critical
for Accurate Understanding.

Who Wrote
the Original Source Documents?

Who Interpreted
the Original Source Documents?

Who Translated
the Original Source Documents?

What was their motive?

What was their agenda?

What was included?

What was left out?

What was distorted?

What was made up?

Have the majority
of Religious Individuals
ever asked these questions?

Or, do they just "*Believe*",
what is presented at face value?

Completely missing,
what is being conveyed
through the
Original Source Documents.

.

The Bible, is a Fraud.

EXPLORATION

For those interested in finding some of the answers to these questions, consider exploring Paul Wallis's work at the following links.

- [The 5th Kind – YouTube channel.](#)
- [Paul Wallis – YouTube channel.](#)
- [Paul Anthony Wallis website.](#)
(<https://paulanthonywallis.com/>)

THE TRUE FACE OF GOD

God is Satan.

Satan is God.

.

Royalty pledges
obedience to God.

Religion pledges
obedience to God.

Governments pledge
obedience to God.

.

Only a Satanic Entity,
is so pathologically desperate
to be worshipped and glorified.

An insignificant, schizophrenic,
reprehensible Entity,
pretending to be
the Creator of the Universe.

·
God Is Dead!

*The greatest trick the Devil ever pulled,
was not, convincing the world he didn't exist.*

*The greatest trick the Devil ever pulled,
was convincing the world he was God.*

THE RELIGION OF NEWTON

Acknowledging and appreciating
Newton's discoveries,
does not mean that One must now
construct shrines and temples to Newton,
calling Oneself a Newtonian.

So why, when acknowledging and appreciating
the Wise teachings of a Christ or a Muhammad,
must One create Churches and Mosques,
calling Oneself a Christian or Muslim?

·
Is this not ridiculous?

*Why do you keep
shooting at the carcass?*

.

*Because some
still aren't convinced
that it's dead yet.*



A BEAUTIFUL ACHING

PRESERVING CULTURE?

“We need to Preserve our Culture.”

Why?

Why should a Culture that has led to Tyranny, be Preserved?

Culture is the Context in which Individuals, hence Societies, operate.

If this Context has allowed Tyranny and Evil to not only establish itself, but to entrench itself so deeply into every aspect of Society, that it now becomes a monumental task to overcome, why would any sane Individual want to Preserve this Culture?

“Culture was better 20, 30, 40 years ago.”

Going back 20, 30, 40 or even 100 years, leads to here.

Why create the same situation for future generations to have to deal with?

It is disgraceful for current generations to even consider regressing Culture to a place that produces the same issues.

Deal with these issues Now!

Sentimental value is not a valid reason to cling to a Culture that allows Tyranny and Evil to flourish.

The Individual requires a complete and total personal overhaul.

Then, from this, Culture will be completely and totally overhauled.

There is no other way.

There is no other viable, long term solution.

For those still unable to see the Tyranny and Evil around them, well, this is very telling.

CULTURAL VIABILITY

A Culture based on Delusional Nonsense
is hardly a Culture worth keeping.

Regardless of its Longevity.

.

Longevity
does not bestow Nonsense
with Validity.

*The definition of Insanity
is doing the same thing over and over again
and expecting a different result.*

Origin Questioned

May not be a legally accurate definition,
but the sentiment is apt.

FEAR OF FEAR

The greatest Fear of all,
is the Fear of being Afraid.

.
Allow the Fear.

Be with the Fear.

Become Comfortable
in the Fear.

.
Transcend the Fear.

THE SOURCE OF CULTURE

Politics may well be downstream of Culture.
But what is not being asked is,

“What is Culture downstream of?”

Culture is downstream of Self-Awareness and Self-Identity.

How an Individual sees themselves,
determines the Culture that is created.

FREEDOM OR EQUALITY?

Creative Freedom
defines
Free Individuals.

Free Individuals
make
Free Choices.

Free Choices
lead to
Unequal Outcomes.

Unequal Outcomes
produce
Diverse Solutions.

Diverse Solutions
result from
Creative Freedom.

.

There can either be, Freedom
or there can be, Equal Outcomes.

There can never be both.

(Based on an original quote by [@naval](#))

*Freedom of Choice
does not mean
Free from Consequence.*

CLOWN WORLD

Whenever things go awry in a circus,
clowns immediately step in to distract the audience.

Things are seriously awry with the current global circus
and clowns are aplenty, performing overtime.

(Paraphrasing an unknown source)

*Western Politics and Governments
have degenerated to such a degree,
that they only function to give
useless and incompetent twats
the ability earn a living as parasites.*

BETRAYING LOYALTY

What validity does Loyalty hold
in the context of friendship?

Is it simply to cover for
malfeasance or inadequacy?

Friendship is about
Trust and Honesty, not Loyalty.

Loyalty to Truth trumps Loyalty to
friends, family or anything else.

.

A Resolute Character
will endure accusations of Betrayal,
when taking a stand for Truth.

Even from those most dear.

A BEAUTIFUL ACHING



A BEAUTIFUL ACHING

S SUBSERVIENT TO ILLUSION

An important thing to recognise; Government Does Not Exist, Government Is Not Real, Government Is An Illusion.

Government, is purely a mental construct.

There is no aspect of Nature or Creation that is the layer or level of Government.

Accepting Government as real, is a trance state that is induced through indoctrination from a young age. Ensuring the idea is neurologically hard-wired into the brain during development, making it more difficult to resolve.

Any perceived actions of Government, are not the actions of an actual Government, they are the actions of Individuals impersonating Authority.

It is Individuals that must be held to account for their actions, not some pretend Government.

Therefore, if Government Is Not Real, then the Power of Government Is Not Real.

So, the Power of Government, is also, an Illusion.

Replace the word, “*Government*” from the preceding assessment, with the word, “*Religion*” and the same holds true.

*Ignorance of Truth and Natural Law,
is no defence against Justice and Restitution.*

Nature has no Statute of Limitation.

CONVENIENT REGIONAL LOCATIONS

BRITISH MAFIA HEADQUARTERS

10 Downing Street and the
Parliament of the United Kingdom.

.

UNITED STATES MAFIA HEADQUARTERS

The White House and the
United States Congress.

.

EUROPEAN MAFIA HEADQUARTERS

European Commission
and the European Parliament.

.

AUSTRALIAN MAFIA HEADQUARTERS

The Lodge and the
Parliament of Australia.

.

etcetera, etcetera, etcetera...

THE DELUSIONS OF POLITICS

Those thinking, all that is needed
is for their side to win an election and
everything will be fine, are delusional.

The changes that are actually required
are far, far greater and deeper than political.

Nothing short of a complete and total
personal overhaul will suffice.

Oh, and material wealth will not save you.

CENTRALISED TYRANNY

CAPITALISM

The Private Formation
and Ownership of Capital.

In other words,
The Government Does Not Own You.

...

COLLECTIVISM

(Communism/Fascism/Socialism Etc.)

Centralised Formation
and Ownership of Capital.

In other words,
The Government Owns You.

What is Government going to do with you,
when it no longer has a need for you?

POLITICAL STEPPING STONES

Nationalism is not the antithesis of Globalism.

Nationalist political structures are merely
stepping stones toward Globalist political structures.

Political structures are nothing more than farm infrastructure.

A true Individual does not blindly cheer for the
sheep station or cattle ranch that they happen to reside in.

MINUS THE BULLSHIT

Government: I will take your money and after my exorbitant expenses, I will give you
table scraps in return.

Individual: But I don't want table scraps.

Government: SHUT UP! Did I say you had a choice in the matter? I will take your
money and after my exorbitant expenses, I will give you table scraps in return and you
better be grateful.

*Government is a Parasite,
that feeds off Society.*

POLITICAL SYSTEMS

Political Systems are a
top-down management structure.

Even though, some Political Systems
may falsely present as otherwise.

Political Systems are a Reflection
of the Population being managed.

Poor quality Population means
poor quality Political System,
regardless of what that system is.

Political Systems themselves
do not create Exceptional Societies,
nor Exceptional Individuals.

Exceptional Individuals
create
Exceptional Societies.

Zero Self Reflection.

The Defining Trait of Vampires.

Tom Luongo

TAKING BACK

Political Actors do not have any
Real Individual Power of their own.

They simple ride the Inertia Wave
of all the Political Power that has been
rolled up into Political Institutions.

.

Maybe it is time to divest
Political Institutions of their Power?

DEMOCRATIC RULERS

Even if One were to buy into
this idea of Democracy,
is it the intent of Democracy
to elect Rulers or even Leaders?

Democracy is sold on the idea
of electing Representatives.
Not installing Leaders
and most definitely not Rulers.

Yet once in power, those elected,
behave like entitled despots.

If this is Democracy,
then Democracy is insane.

.

Representatives are intended to be
subservient to those they serve.

So, where in the world,
does an actual Democracy exist?

QUALIFIED INCOMPETENCE

Not qualified or competent to
clean toilets for a living?

Become a Politician
or Senior Bureaucrat.

.

Apply Now,
at any
Western Country.

POLITICAL FUNCTIONARIES

When Political Functionaries are no longer able to receive directives from competent overlords and masters, they are forced to operate from their own unremarkable intellect and abilities.

This is often reflected in very erratic and confused behaviour. Exposing poor individual qualities and incompetence for all to see.

Observers then point out the startling reality that,

“The Emperor has no clothes.”

POLITICAL INFIDELITY

A Politician engaging in Infidelity,
is not a primary issue for concern.

The predominant quandary arises,
because the Politician willingly betrays
a spouse and children in the process.

Thus deceiving the very Ones
they supposedly most care about.

.

If a Politician so easily disregards,
those seemingly most dear,
what would they willing do,
to you and your family?

POLITICS VS DIPLOMACY

Politics, is Maliciously Manipulative.

Diplomacy, is Honestly Interactive.

.

Politics, is Ruling over
other Sovereign entities.

Diplomacy, is Engaging with
other Sovereign entities.

POLITICAL GAMES

An Individual looking to genuinely resolve a conflict with family, friends, neighbours or acquaintances, does not resort to Politics for the solution.

One is unlikely to manipulate the situation simply to maximise the benefit for themselves, whilst undermining and devaluing the needs and concerns of their counterparty.

A Real Solution, to genuine conflicting concerns, would at least bestow some benefit to both sides or have rational reasoning for being one-sided.

There are no Political Games being played in this type of scenario.

On the other hand, Politics is the opposite to this, where Political Games are the order of the day.

*Politics is a Game of Underlying
Petulance, Spite and Resentment.*

*With War being
Politics to the Extreme.*

Political Solutions, are the Worst Solutions.

.

A situation where one side seeks a genuine solution, but the other is playing Political Games, makes finding a Real Solution very difficult.

A situation where both sides are playing Political Games, means no Real Solution is possible.

NATIONAL INTERESTS

When Politicians regurgitate the cliché, “*National Interests*”, they do not mean your interests, they mean the interests of the Political Establishment.

If you, your family or community gain some benefit from “*National Interests*”, this is simply a by-product and not the primary intention of “*National Interests*”.

When determining “*National Interests*”, your interests do not factor into the equation at all.

Of course, the obligatory public relations spin will be served up into your dog bowl, to keep you compliant.

ALLIANCES OF HYPOCRISY

One sided, politically motivated statements and actions
will always eventually result in hypocrisy.

Conducting affairs in a principled and rational manner,
without preferential treatment or outcomes,
has no such problem.

AUTHORITARIAN SAVIOURS

When a minority group delights
in having Authoritarians vanquish
their perceived oppressors,
it will not be too long before
those Authoritarians turn on them.

.

Because this is just what,
Authoritarians are.

LAW

An Attempt to Codify Wisdom and Morality
Based on the Sovereignty of the Individual.

Should any Individual or Collective
violate the Sovereignty of another Individual,
then Remedies for Justice are called for.

.

Law should be Based on
Natural Fundamental Principles,
not separate Laws for each and every
possibility and circumstance.

In this way, a brief and concise Codex of Law
can be made available and Understood by all.

.

A consideration for the Definition and
Guiding Principles in the creation of Law.

COURT OF LAW

The role of a Court of Law
is not to interpret the Words of the Law.

It is to interpret the Intent of the Law
and Issue Remedies for Justice
Foundationally Based on Wisdom, Morality
and the Sovereignty of the Individual.

MORAL JUSTICE

“Morality Cannot Be Legislated...”

.

Moral Behaviour itself may not be able to be Legislated,
but Morally Based Legislation is the Foundation of Justice.

.

If Legislation is not Based on Wisdom and Morality,
what then is it Based on?

NATURAL LAW

If One were to jump off an extremely tall build unassisted, One would most likely encounter a somewhat immediate and terminal expression of Natural Law.

However, Natural Law does not always operate with such expediency.

Natural Law, shall quite often play out over time in discreet and subtle ways, that might not be so obviously connected to causal action. Setting up the Context for lessons to be learned in a far deeper and more meaningful manner.

Wilful Ignorance of Natural Law, only leads to consequences that are both unexpected and bewilderingly.

In reference to any Injustice incurred, those that attempt to hinder or thwart the Natural resolution of Injustice, may find the Remedies for the Injustice significantly compounded.

All real Injustice will eventually be resolved, regardless of the measures taken to avoid or resist.

Natural Law, for the most part, is Context Driven.

*Historically, the most terrible things,
War, Genocide and Slavery,
have resulted not from Disobedience,
but Obedience.*

Howard Zinn



A BEAUTIFUL ACHING

T THIS IS SERIOUS

YOU'RE SO SHORT

You're so short.

How short are you?

.

You're so short,
that you need a ladder
to scratch your own ass.

YOU'RE SO BLACK

You're so black.

How black are you?

.

You're so black,
that midnight needs to
turn on the lights
to be able to see you.

YOU'RE SO BLONDE

You're so blonde.

How blonde are you?

.

You're so blonde,
that even Blonde Jokes
make fun of you.

BIG NOSE?

Q. What is Nature's purpose
for a big nose on males?

A. Advertising.

WHY S'S RATHER THAN S' ?

It is a personal preference to use s's to show the possessive form of a word ending in the letter "s", rather than the more conventional s'.

Why?

Because s' is reminiscent of a man walking around a party, with his penis hanging out of his pants.

Why would you do that?

Just put it back in your pants.

THE WRINKLY PICKLE

Q. Have you heard about
the new Harry Potter spin off?

A. It's called Barry Hotter,
a gay stripper from
The Wrinkly Pickle
in Hogsmeade.

POLITE SOCIETY

*"Politics or Religion
are never discussed
in Polite Society."*

.

Oh!

It seems an invitation into Polite Society
should not be expected any time soon.

PUNCHING DOWN

Don't Punch Down.
Use your feet and Stomp Down.

It's Easier.

A BEAUTIFUL ACHING



A BEAUTIFUL ACHING

NEVER-ENDING GOD NONSENSE

There are still many that are waiting for their God to come and save them.

The reason the world is in the mess that it finds itself, is primarily because of, God Nonsense.

The solution that they continually regurgitate, is more, God Nonsense.

There is no God, that is going to come and save you.

There is no Jesus, that is going to come and save you.

There is no Muhammad, that is going to come and save you.

There is no Buddha, that is going to come and save you.

There are no Aliens, that are going to come and save you.

The only thing that is going to save you, is YOU.

If you cannot find a way to save YOU, then it is not going to happen.

So best put any delusions aside about looking for saviours.

YOU, are your only saviour.

Because if YOU, cannot find a way, no one can.

GATEWAY FOR MANIPULATION

Worship and Obedience
toward perceived Gods and Deities,
is purely a Gateway for Manipulation.

.

Manipulation is most effective
when it is Covert, rather than Overt.

MEANINGLESS DIVERSION

The reason why praying
to external deities
is indoctrinated at young,
is to keep One occupied,
whilst changing nothing.

PRAY THE TYRANNY AWAY

The phrase,
“Pray the gay away.”,
is used with mocking derision.

The idea to
“Pray the tyranny away.”,
should be just as equally scorned.

MEDITATION VS PRAYER

The objective of Meditation,
is to draw Awareness Inward.

The objective of Prayer,
is to draw Awareness Outward.

TEACHER VS SAVIOUR

A Strong Individual acts toward
developing other Strong Individuals
to engage and interact with.

A demented Ego looks for victims
to “*save*” and manipulate.

THE PURPOSE OF KNOWING

One cannot save Others from drowning,
if One does not Know how to swim.

The main purpose of Knowing to swim,
is not to save Others from drowning.

The main purpose of Knowing to swim,
is in Teaching Others to swim.

THE CHRISTIAN CRUTCH

Why does a Christian use Christ as a Crutch
to be a Moral Individual of Integrity?

Be a Moral Individual of Integrity,
all on your own.

PSYCHO-TEMPORAL BUBBLE

Is modern day Science locked into
2000+ year old Understanding?

Is modern day Mathematics locked into
2000+ year old Understanding?

Is modern day Medicine locked into
2000+ year old Understanding?

Is modern day Technology locked into
2000+ year old Understanding?

.

Why then is Creation, the Universe
and Humanity's place in it, still locked into
2000+ year old Understanding?

Why has this Understanding
not developed or evolved?

Why is some old book still taken
as the definitive authority in this regard?

Is it Conservative
to be locked into a
Psycho-Temporal Bubble?

BORN SINNERS

When a newborn child
is brought into this world,
Christians consider it,
"A Born Sinner".

Yet quite often they will refer to,
"The Innocence of a Child".

Well, which one is it?

It cannot be both.

.

Why would any Individual worship
an insane entity that considers
all newborn children,
"Born Sinners"?

Christians believe this,
because it was written
in an old book.

PERVERTED LOGIC

*“Yeah sure, Religions have done some bad things in the past,
but that doesn’t mean we have to throw away Religion.”*

Similar logic, different scenario.

*“Yeah sure, Barry is a mass murderer,
but he does go to church every Sunday
and hands out lollipops to children.”*

If your Righteous Institution
is the cause of millions of people’s death,
then your Righteous Institution
is probably not very Righteous.

.

What, False Facades are not a thing?

*If your God is all about
Murdering the Innocent,
then F@#k Your God!*

MENTALITY OF A MORON

My God’s dick is bigger
than your God’s dick.

LESS THAN HUMAN

If One is constantly treated as being Less Than Human,
why is it then a surprise when One behaves, Less Than Human?

Conversely.

One should never excuse behaviour that is Less Than Human.
One should always find the Resolve to maintain One's Humanity.

*If One responds to Barbarity with Barbarity,
does that not make One a Barbarian?*



A BEAUTIFUL ACHING

P PONTIFICATING POPPYCOCK

According to the
political establishment...

Populism, "*Bad*".

But!

Democracy, "*Good*".

*

According to the
political establishment...

A vaccine protects
from viruses.

But!

The unvaccinated
are a danger
to the vaccinated.

*

According to the
political establishment...

Humans are the cause
of the climate changing.

But!

What should the climate be right now,
if it were not for Human influences?

What is the baseline climate
against which Human factors
can then be measured?

*

According to the
political establishment...

Humans are the cause
of the climate changing.

But!

If you give more of your money to the government
and eat bugs, this will then “*fix*” the weather.

*

According to the
political establishment...

On the 11th of September 2001,
nineteen terrorists hijacked four commercial airliners
and crashed two of them into two sky scrapers,
causing three buildings to collapse
into their own footprint.

No government official
knew anything about this
prior to these events occurring.

But!

Within forty-eight hours,
the establishment media was reporting
the Who, How and Why
of what had just transpired,
without any investigation taking place.

Before the dust had even settled
from the flattened towers.

*

Hmm.

How does any of this
make sense?

*Truth is often Confronting,
to those that Lie to themselves.*



A BEAUTIFUL ACHING

T THE MYTH OF EQUALITY

Equality – Of Equal Quality.

The Equality of Individuals is a Myth.

The Quality of Individuals
varies greatly
between Individuals.

Areas of variation include,

Moral Quality,
Strength of Integrity,
Levels of Courage,
Intellectual Capacity,
Physical Attributes,
Talents and Abilities.

These are characteristic examples
that vary amongst all Individuals.

Inequality is not something
to be Resentful of.

Inequality is something
to be Grateful for.

Inequality is the Foundation of
differing Perspective and Understanding.

Inequality allows
Energy to Flow.

Equality causes
Energy to Stagnate.

But it is also important to note,
that Quality can always be improved.

Individual Quality
is not set in stone.

.

The aspect of the Individual
that is common to all,
is Sovereignty.

ERRORS IN INDEPENDENCE

“All men are created equal...”

No! They are not.

.

“Every Individual Is Sovereign.”

This, is the actual fact of the matter.

SOVEREIGN ACCOUNTABILITY

It is not possible for Sovereignty to be
Subservient or Subordinate to anything.

However, Sovereignty is Responsible
and Accountable for its actions.

STRONG BRICKS, STRONG WALL

If One were to build a brick wall,
but the only bricks available
are porous and crumbly,
then the wall that is built,
will not last the next rain storm.

Poor Quality Bricks,
Poor Quality Wall.

.

By comparison,
High Quality Individuals,
High Quality Society.

DEATH THROES OF INCOMPETENCE

Political parasites eventually become so incompetent,
that they are unable to achieve anything meaningful.

Resorting to frivolous grandstanding and virtue signalling,
as a final effort of projecting a feeble appearance of proficiency.

*Incompetence resorts to Virtue Signalling,
as a means to falsely project Quality.*

FINANCIAL STRATIFICATION

Financial Wealth Inequality
is like the rungs on a ladder.

If the rungs are spaced closely enough,
then moving up and down the ladder is relatively easy.

If the rungs of the ladder are spaced too far apart,
then moving up the ladder is impossible
and moving down the ladder becomes terminal.

This is a disaster all round.



A BEAUTIFUL ACHING

T TRAVERSING THE DARKNESS

Traversing the Darkness is transitioning to an unknown destination, along an unknown path.

It will never be possible and likely not desirable, to have the ability to perceive all the steps in between.

At times, the veiling fog may only allow the next step to be visible. Presenting no other option but to hesitantly proceed.

At others, the fog could recede to despairingly expose the absence of steps in any direction, with waiting being offered as the mandatory choice.

Presuming steps that are not, simply steers One astray. Becoming perpetually lost, a real possibility.

Debilitating turmoil encountered often on this path, breeds respectful familiarity for its lessons and its ways.

Darkness pressing hard against One's face, crushing with its force, uncovers terrified apprehension and reluctance to pass through.

However, fearing to go on, determined to retreat, reveals the impassable wall directly at One's back.

This is the path, the path Traversing the Darkness. The path which seems endless in both distance and pain.

Yet even in such Darkness, sparks still alight. Giving brief clarity and resolve to push on ahead.

Then as each spark coalesces within Awareness's flame, clarity's briefness extends down the way.

Traversing the Darkness does eventually end, at the destination that is Now, the destination that is Home.

The True Path is the Inner Path.

The Path upon only the Individual can walk.

FACE THE DARKNESS, RESOLVE THE DARKNESS

The primary reason for issues such as obesity, drug abuse, alcoholism and others, is an unwillingness to face Emotional and Psychological Darkness.

When One is faced with Emotional and Psychological Darkness, attempts to make Oneself feel better may be undertaken, as an avoidance to dealing with the Emotional and Psychological Darkness itself.

Rather than trying to make Oneself feel better, directly face what is being felt and experienced.

Allow Awareness to Transition the difficulty through Darkness.

Giving opportunity for the Light of Consciousness, to Transmute it along the way.

*Facing the Darkness
does not mean
Wallowing in Darkness.*

ESCAPISM

Ugly Word.

Ugly Concept.

.

*“My mindless entertainment is not at a level
sufficient to keep me distracted.*

ROARRRRRR!

*I refuse to engage with the things
that are Hard and Difficult,
while I expect Others to resolve
those things that are Hard and Difficult.*

ROARRRRRR!

*Then, I expect Others to hand me the solutions
to the Hard and Difficult things on a silver platter,
so I can utilise them at my convenience.*

ROARRRRRR!

Those solutions better not be Hard and Difficult.

ROARRRRRR!

*Now leave me alone so I can distract myself from
all the things that are Hard and Difficult.*

ROARRRRRR!”

.

Escapism,
thanks you for your efforts.

*Escapism often fantasises
about being the hero,
but rarely contributes to
anything creative or meaningful.*

A SUCCINCT SUMMATION

The manifestation of Evil in this world is a direct consequence of the cumulative unwillingness of Individuals to Face and Resolve the unfathomable depths of festering, putrid wounds, left by Unresolved Inner Conflicts compartmentalised within the Shadow Self.

Resulting in Awareness being pushed to an extreme separation from the Conscious Source.

Look Inward and Resolve the Inner Conflict, the Inner Darkness.

Thus helping to flush out and Resolve Evil in the process.

Darkness itself is not Evil.

*Evil just chooses to hide
in the Darkness.*

*Whilst often proclaiming
to be the Light.*

HISTORY REPEATS

“History doesn't repeat itself, but it often rhymes.”

.

Only because past issues
have yet to be fully Resolved.

Resolve them
and Reveal a New Future.

.

All Resolution is found
on the Inner Path.

THE CYCLE OF TYRANNY

In a Depleted or Degraded state of Awareness,
Today's Victims become Tomorrow's Tyrants.

USELESS PROFESSIONS

A question to the Psychologists and Psychiatrists reading this, how is an Individual that has never experienced extreme, deep and prolonged Emotional and Psychological turmoil, supposed to help Another experiencing extreme, deep and prolonged Emotional and Psychological turmoil?

Experiencing extreme, deep and prolonged Emotional and Psychological turmoil is not an illness! It is a part of a Process!

A BEAUTIFUL ACHING

One cannot guide Another through a Process, if they have not fully experienced the Process themselves.

The vast majority of Psychologists and Psychiatrists are little more than Pretenders and Frauds.

Dishing out garbage psychotropic drugs to cover for their laziness and ignorance.

Extreme, deep and prolonged Emotional and Psychological turmoil is not a chemical imbalance!

(Mandatory Disclaimer. This is not health advice.)

Psychologists and Psychiatrists that would like to truly help clients that experience Emotional and Psychological turmoil, direct them to this work so they gain a foundational understanding of the Process.

Then offer to play a part as an objective observer, presenting suggestions and insights to their specific case in order to help them gain clarity and direction.

Also, learn from their experience of going through this Process to better assist Others and possibly Oneself.

This is all predicated on the condition that the Psychologist or Psychiatrist is familiar with the information provided in this volume.

A STOIC FACADE

Appearing Stoic is not necessarily a representation of an incapability to feel extreme and intense Emotion, or of repressing Emotion.

A Stoic appearance may simply come about because Emotional intensity is so great, that the Physical Body just does not have the ability or capacity to express it.



A BEAUTIFUL ACHING

NEGATIVE VALUE?

The Cartesian Co-ordinate System uses Negative (-) as an indicator of Direction, not Negative Value or Negative Quantity.

What is Negative Value?

What is Negative Quantity, when physical Quantity cannot be Less Than Zero?

There is no, Less Than Zero.

Zero is the Baseline.

Zero is the Foundational Context.

It is physically impossible to have a Negative number of oranges or a Negative length measurement.

What does Negative Value or Negative Quantity mean?

Negative Value or Negative Quantity are not Real.

Negative Value or Negative Quantity is not the same as Negative Polarity or Negative Charge.

Zero on a Polarity scale indicates Equilibrium.

With increasing Positive and Negative values representing the separation from Equilibrium.

This is very much different to Zero in a Value or Quantity perspective, or Zero in the Foundational Context perspective.

A BEAUTIFUL ACHING

Context matters.

In a way, Value could also be considered as Quality.

.

What are Negative Numbers?

What is the Square Root of a Negative Number if the Negative is an indicator of Direction only?

What are Imaginary Numbers?

What actual meaning do they have?

Are they anything other than a mathematical trick?

.

What is the Debt that is created in a Fractional Reserve banking system?

Is it creating Negative Value?

What are the consequences of creating Negative Value?

What are the consequences of creating ever increasing amounts of Negative Value?

Are Negative Value Debt Instruments a financial vacuum designed to draw wealth into concentrated pockets, with as little effort as possible?

Again, what is Negative Value?



A BEAUTIFUL ACHING



AWARENESS STABILITY RANGE

An Awareness Stability Range is a measure of an Awareness’s ability to remain stable within a defined span of the Light/Darkness Polarity Scale about the Equilibrium point.

Over many generations and including current lifetimes, this range has been reduced to the point that even a minor disruption causes many to become Emotionally and Psychologically unstable.

Primarily resulting from an obsessive refusal to experience any discomfort at all.

A Natural process exists to broaden and improve this range. However, allowance of difficulty and discomfort is essential and it must not be resisted or obstructed in any way.

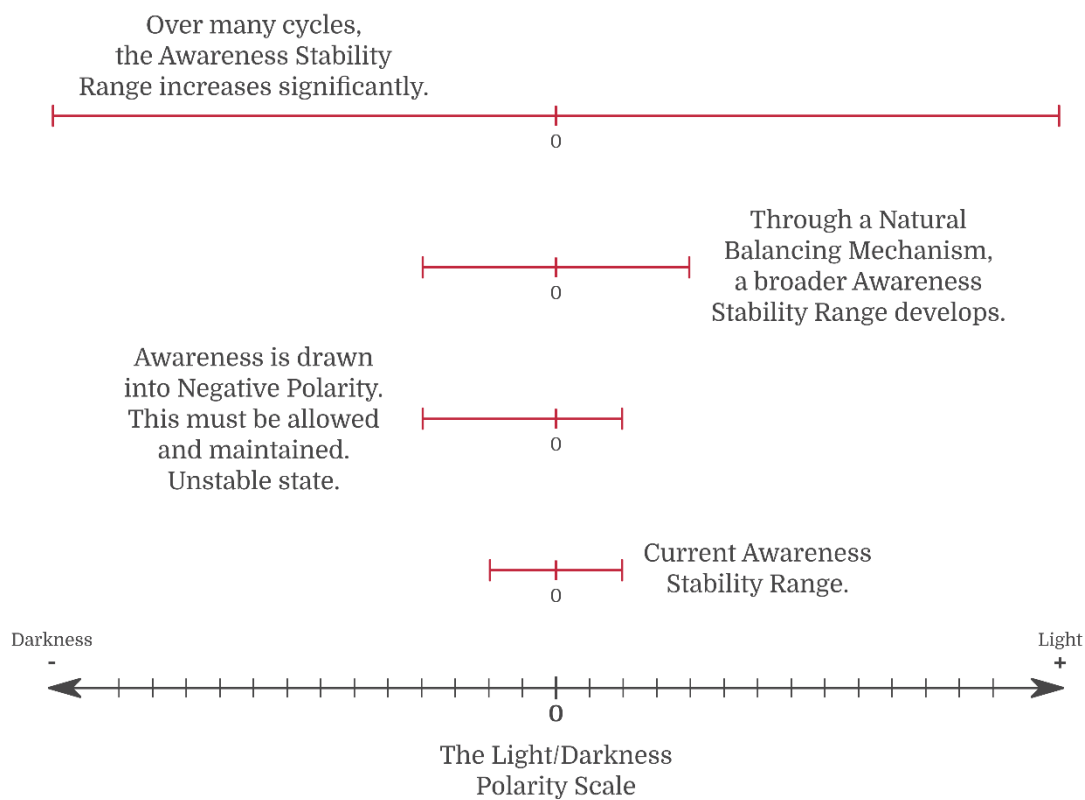

AWARENESS STABILITY RANGE A NATURAL ADAPTIVE PROCESS

A BEAUTIFUL ACHING

The above diagram outlines the individual steps in this Natural process and given a sufficient amount of cycles, the range of stability an Awareness is able to reside within can be significantly improved.

It is also possible for this process to function in the opposite manner, where Awareness is first drawn into Positive Polarity, then the Natural Balancing Mechanism develops toward the Negative.

An unstable Positive Polarity state is expressed through over excitement and exuberance.

*The Deeper the Roots,
the Higher the Branches.*

OBSERVING POLARITY

One is neither, Positive nor Negative.

One is also not to favour, Positive or Negative.

The goal, is to Clarify and allow Oneself
to be the Pure Observer of, Positive and Negative.



A BEAUTIFUL ACHING

NONSENSICAL NUMEROLOGY

Why is the Gregorian Calendar structured the way it is?

Why is there no meaningful structure to the Gregorian Calendar?

Why is the first day of a year positioned where it is?

Why is it not on a Solstice, or at least an Equinox? These seem to be more logical positions.

Why is the year broken down into 12 months?

Why does February only have 28 days, not including a leap year?

Why not take a day from any two months with 31 days and give it to February, so it has 30 regular days, like many other months?

Why is a week 7 days?

Is it only because some God, in some old book, was claimed to have created the Earth in 7 days?

What is the purpose of breaking up the year into weeks and months?

Why was it not broken up even further, creating another grouping of days?

Why is the foundational year of a calendar set to an Individual's perceived birthday?

Why is the foundational year of the calendar not set to the birthday of the Buddha, or any other countless examples of Individuals presenting similar quality?

Why is the foundational year of the calendar not set to some tangible celestial reference or major planetary event?

A BEAUTIFUL ACHING

Does the perceived structure of Time have an effect on the structure and stability of Human Psychology?

If the perception and measurement of Time has an arbitrary foundational framework, does that then effect Human Psychological foundational framework?

So what value is Numerology when a calendar is based on arbitrary premises?

Why do Numerologist only espouse cherry-picked examples of success, but never disclose Numerology's many failures?

If a field of study is based on arbitrary and nonsensical premises, does that not make the field of study itself, nonsensical?

*A Number only has Meaning
when Referenced to a
Foundationally Meaningful Baseline.*

DISTANCE TO THE SUN

What is the distance between the Earth and the Sun?

3? ... 3 what?

7? ... 7 what?

45? ... 45 what?

1253? ... 1253 what?

What value are Numbers, without any Meaningful Context?

FALSE EQUIVALENCY

1 Apple \neq 1 metre \neq 1 mile \neq 1 kilometre \neq 1 kilogram \neq 1 Newton \neq 1 Volt \neq 1 kilowatt.

The number 1 is common among all of the above measures, but none of them mean the same thing. None of them are equivalent.

1 inch = 25.4 millimetres.

1 is a different number to 25.4. Yet, the two measures above, are equivalent.

So how does Numerology resolve this, if numbers, all on their own, without context, have meaning?



A BEAUTIFUL ACHING

FAKE IDENTITY, SUPERFICIAL IDENTITY

Considering Oneself
American
is Fake Identity.

Considering Oneself
Australian
is Fake Identity.

Considering Oneself
Chinese
is Fake Identity.

Recognising Oneself
of Asian Race
is Superficial Identity.

Considering Oneself
Russian
is Fake Identity.

Recognising Oneself
of Slavic Race
is Superficial Identity.

Considering Oneself
Christian
is Fake Identity.

Considering Oneself
Muslim
is Fake Identity.

Considering Oneself
Jewish
is Fake Identity.

Recognising Oneself
as Male
is Superficial Identity.

Recognising Oneself
as Female
is Superficial Identity.

Considering Oneself
as White
is Fake Identity.

Recognising Oneself
as White Skinned
is Superficial Identity.

Considering Oneself
as Black
is Fake Identity.

Recognising Oneself
as Black Skinned
is Superficial Identity.

Recognising One's
Ethnic Heritage
is Superficial Identity.

Culture is not Identity
because Culture changes
with Understanding.

.

All Nationalistic Identity,
is Fake Identity.

All Religious Identity,
is Fake Identity.

All Ideological Identity,
is Fake Identity.

All Racial Identity,
is Superficial Identity.

All Genetic Identity,
is Superficial Identity.

.

Individuality,
is True Identity.

IDENTITY DILEMMA

Being Hung-Up on
and Clinging to Fake Identity,
makes it impossible to Discover
and Express, True Identity.

ACCEPTING SUPERFICIALITY

Once a Superficial Identity
has been accepted as totality,
a deeper more meaningful True Identity,
is left unexplored.

EGO IDENTITY

Ego needs a
Religious Identity.

Ego needs an
Ideological Identity.

Ego needs a
National Identity.

Ego needs a
Cultural Identity.

Ego needs a
Racial Identity.

.

Why?

Because Ego has no Identity,
so Ego must scrounge Identity
from external sources.



A BEAUTIFUL ACHING

CROWDED CONSCIOUSNESS

Consciousness
has no room for the Ego.

Consciousness
has no room for the Other.

Consciousness
has no room for a God.

.

Because Consciousness,
is Singularity.

Singularity is not God.

*It is not a Santa Claus in the sky
that must be obediently worshipped.*

MIRROR, MIRROR ON THE WALL

Woke Indoctrination and Religious Indoctrination
are a Mirror for one another.

Both Reflect back the absurdity of the other,
for those that are willing to See.

...

Wokeness is in Conflict with Religion,

just like

Communism is in Conflict with Fascism.

.

Both are just two sides of the same coin.

PARASITIC RAPE

Religion, is a Rape of the Soul
and God, is its Phallus.

—

Wokeness, is a Rape of the Soul
and D.E.I., is its Phallus.

.

When Awareness is at
such a shallow state,
the act of Raping the Soul
will not even be realised.

*One can observe Another being Raped
and point out the obvious violation.*

*But if the Other has conceded to being Raped,
then there is little One can do to intervene.*

CIRCLING VULTURES

There is no Karmic Debt incurred,
if One accedes to the Violation.

Failing to assert One's Sovereignty,
ensures that the Vultures come calling.

.

If an Individual or Entity seeks
to Violate your Sovereignty,
make them Incur and Accumulate
Karmic Debt.

One way this is achieved,
is with the simple word...

NO!

.

This is not about the word itself,
it is about Resolve and Intention.

SPIRITUALITY, NOT RELIGION

Spirituality,
is about You.

Religion,
is about control over You.

POOR INVESTMENTS

It is quite often the case,
that those that are most
Religiously Invested,
are actually
Spiritually Poor.

AN END TO PANDERING

It is time to adopt a Scorched Earth Policy
regarding all Lies and Untruths.

Ideological, Political, Religious and Other.

It is time to End this, Pandering to Delusion.

*Belligerently pedalling Nonsense,
deserves an equally measured Smackdown.*

DELUSIONAL OBLIGATION

If One chooses to Delude themselves
with Ideology or Religion,
that does not then Obligate Another
to pander to those Delusions.

GOD, CREATOR AND SAVIOUR

If God is both Creator and Saviour,
why does this God create the calamity,
that then requires One to be saved?

Many will proclaim,
“Free Will” is the cause.

But if this is so,
why then give One
“Free Will”?

.

Religious Individuals
will contort themselves
into six dimensional pretzels,
attempting to validate
the nonsense they believe.

.

At this point,
only Cowards, Fools or both
still cling to the idea of a, *“God”*.

...

Does Humanity have any idea
of how many times
Humanity has already been saved?

How many more times
does Humanity need to be saved?

Enough is Enough.

MORAL CONTEXT

Morality is a
function of the Psyche.

The Soul is to
Experience and Understand.

Consciousness is the
Observer of it all.

.

Morality, to a significant degree, is a product of environment, culture and upbringing.

Although, accumulated Soul experience and Understanding can seep its way down to shallow Awareness states.

Playing a “*good person*” does not directly correlate to Spiritual development.

When required, a highly developed Soul can and does play the role of Malicious Antagonist.

The Malicious Antagonist is often brought forth to counteract deeply ingrained, comfortable delusion and ignorance.

The reason a highly developed Soul is most suitable for this purpose, is because of its willingness and ability to take on any Karmic Debt that may be incurred.

*Creation does not give a shit
about your God worship.*

FALSE ASSOCIATION

Associating Morality with Religion,

is like

Associating Intelligence with Paedophilia.

.

The two things have nothing
to do with each other.

METAPHYSICS 101

Knowing and Accepting Truth
has a Stabilising effect on Reality.

Believing Lies and Untruths
has a Destabilising effect on Reality.

.

Transforming from a False Reality of Lies and Untruths,
to a Reality based on Understanding and Knowing Truth,
has a Tumultuous Transition Phase.

.

God and Religion are the Foundational Lie,
deeply encrusted into the Human Psyche.

GOD BLESS

If God did exist,
who are you to tell God what to do?

Since God does not exist,
what does that even mean?

.

It is even more baffling to hear
an Individual that is not Religious proclaim,

"God Bless."

WAITING FOR GOD

Has your God
saved you from War?

Has your God
saved you from Famine?

Has your God
saved you from Pestilence?

Has your God
saved you from Natural Disaster?

Has your God
saved you from Political Tyranny?

Has your God
saved you from Violence?

Has your God
saved you from Rape?

Has your God
saved you from Murder?

.

So, if not for these things,
when is it exactly,
that your God
is going to save you?

DESTROYING COMPETITION

The Goal of Communism
is not to Destroy Religion.

The Goal of Communism
is to Destroy Competition.

.

Religion's Worship Imaginary Gods.

Communism Worships the State.

.

Communism, is Religion.

CLEARING THE VOID

When a Void that is created by a Question, is occupied by a Belief,
then there is no possibility for the Truth to make itself Known.

Clearing that Void, makes way for the Truth.

.

Belief, is a Sin.

DREAMS OF HEAVEN

All that is presented here, is intended as a map, leading those lost in the confines of
Darkness, out into the Sun.

Those already out in the Sun, do not require any map.

Then there are those, asleep in the Darkness, endlessly dreaming about a painting of a
Sun.

Refusing to wake up.

*If historical figures were able to
discover Truth thousands of years ago,
what then, is stopping You,
from discovering Truth, Now?*



A BEAUTIFUL ACHING

R RULES OF THE GAME

NATURAL KARMIC LAW

Natural Karmic Law governs interactions between Sovereign Sentient Individuals and Entities.

The severity of Natural Karmic Consequence is determined by the depth of Sovereign Awareness of the affected Individual and their willingness to assert Sovereignty.

Abdicating Sovereignty to some God or other party has the effect of dampening the consequences of Natural Karmic Law.

Natural Karmic Law can only be fully applicable to Fully Sovereign Sentient Individuals and Entities.

SOVEREIGNTY SUPERSEDES LAW

Individual Sovereignty Supersedes Man-Made Laws.

If a Sovereign Individual is unjustly hindered from pursuing their natural course of life by another Individual or Entity, then that Individual need only assert their Sovereignty for Karmic Law and Consequence to begin taking effect.

Karmic Law, generally allows time for grievances to be settled between parties. But, should this fail, Karmic Law may offer a substantial amount of rope for the offending party to hang themselves with.

Karmic Law will always justly resolve any situation; across life-times, if necessary.

Karmic Laws are not written Laws, but are innately Understood when Awareness is of sufficient depth.

Man-Made Law cannot override Natural Karmic Law.

PRESIDING IN JUDGEMENT

One that places themselves in a position of Judgement over another Sovereign Individual, comes under the oversight of Natural Karmic Law.

If an innocent Sovereign Individual is wrongly adjudicated and penalised, then Natural Karmic Law may play a part in redressing the injustice.

If the injustice is an error due to such things as insufficiently understood evidence or information, then counter-balancing remedies will likely only be minor. Provided that the error is swiftly corrected, if and when clarity emerges surrounding the contentious events.

In other words, Errors of Good Faith are deemed more or less neutral in the context of Natural Karmic Law.

However, if the injustice is the result of Maliciousness or Corruption, then Natural Karmic Law could play-out in a merciless way toward those that Sit in Judgement.

Any attempts at deceiving Natural Karmic Law are a laughable absurdity.

Unjust, Corrupt systems, must by necessity, become more and more Unjust and Corrupt, in an attempt to hold back the consequences of Natural Karmic Law.

This only then leads to a more catastrophic collapse, when it eventually comes.

SOVEREIGN CONTRACTS

Contracts are created between Sovereign Entities for a specific purpose or to achieve a required outcome.

Once the specific purpose is no longer applicable or the outcome has been achieved, the Contract is fulfilled and thus, ended.

If a party breaches any term of the Contract, the Contract is voided and agreed-to penalties may apply.

All Contracts must have some form of termination mechanism.

There is no Natural Foundation for Perpetual Contracts.

Under Natural Karmic Law, any Perpetual Contracts are null and void.

Soul Contracts are a Foundational way in which Sovereign Entities interact on a much deeper level.

Conditions and Boundaries of applicable Soul Contracts will become known to an Individual when Awareness is of sufficient depth.

Awareness of Conditions and Boundaries of Soul Contracts is not a requirement for them to be carried out or enforced.

LEVELLING THE PLAYING FIELD

[A Beautiful Aching](#) presents Foundational Understanding to all Individuals on this world, with a depth and detail that has not been previously available.

This is so all have the opportunity to Understand the Rules of the Game, in a fair and equal manner.

Thus, let the chips fall where they may.

Advantages in material wealth, technology and/or political force, are of little consequence in the face of Natural Karmic Law.

EMBRACE
YOUR
SOVEREIGNTY!

STOP
ABDICATING SOVEREIGNTY!



A BEAUTIFUL ACHING

WORSHIPPING INSANITY

Imagine any other Individual
acting in the same way and
making the same demands of you,
as your God does.

Would you not consider
that Individual, Insane?

So, what do you actually Worship?

VALENTINE'S DAY IDEA

Wondering how to show that special someone,
that you love and respect them deeply?

Have an image or symbol of them
being tortured, hanging on your wall
or as jewellery around your neck.

It works for Christians.

.

Christianity does not Glorify Christ.

Christianity Mocks Christ.

Christianity Disgraces Christ.

SATANIC RELIGIONS

All Religions are Satanic.

Because only Satanic Entities and Individuals
are so Parasitically Insecure and Pathetic,
that they Crave the need
to be Glorified and Worshipped.

.

The Defining Feature
of any Satanic Entity,
is that it is Parasitic.

SLOW REALISATION

How long has it taken for many to realise
that Government does not and has never,
primarily worked for their best interests?

How long is it going to take for many to realise
that Religion does not and has never,
primarily worked for their best interests?

.

Eventually, Uncomfortable Realities
will need to be faced.

OPINION IS NOT TRUTH!

There are no Opinions about Truth!

Either, One Understands
and Knows Truth,
or One does not.

It is not an Opinion on whether
the Laws of Physics are Valid within|
the Context in which they are Defined.

The Laws of Physics do not require
a Belief in them, to Validate them.

In fact, Belief in the Laws of Physics
is completely irrelevant.

Either, One Understands
and Knows these Laws,
or Ones does not.

.

Religious Opinion Is Not
Understanding and Knowing Truth!

SOVEREIGNTY MEANS

Being Subordinate to some God
means that you are not Sovereign.

.

Sovereignty means,
A Sovereign.

SWEET POISON

The term "*God*" may imbue some
with Pleasant and Comfortable feelings,
but Poison is more easily ingested
with a Sweet and Delightful flavour.

.

The term "*God*" is laden
with so much Poison,
that it is best left alone.

SPIRITUALITY ≠ RELIGION

Religion is a Parasite
that has attached itself
to Spirituality.

.

Spirituality ≠ Religion.

TRUE DISCOVERY

What is actually important,
is a Strong Spiritual Identity,
flowing from Deep Self-Awareness.

Religious Identity is the façade,
Indoctrinated from young,
to hinder True Discovery.

.

Spirituality ≠ Religion.

INDEPENDENT UNDERSTANDING

Independently verifying
and confirming the Grander Truth,
whilst using the work of Others as a reference,
is a perfectly valid approach to take.

Constantly regurgitating the work of Others,
only demonstrates One to be a fraud.

*It is the Pseudo-Scholar's forte,
to be constantly regurgitating old scriptures.*

GOOD PEOPLE

These incessant attacks on Religion, particularly Christianity, are not because of any animosity toward Religious people.

Most Religious people, are Good People.

It is just disappointing to watch Good People being so grossly deceived.



A BEAUTIFUL ACHING



ORWELLIAN RE-BRANDING

It is interesting to see the Fascists
have now Re-Branded themselves as
Anti-Fascist.

But with an extra dose
of Self-Righteousness.

PROTECTING LIES

The reason for Censorship Laws
is not to Suppress Lies.

The reason for Censorship Laws
is to Suppress Truth.

.

Truth needs no Law to protect it.

FREE SPEECH

Free Speech allows a Fool
to prove they are a Fool.

Censorship means,
the Fool is never challenged.

NOTHING TO HIDE, NOTHING TO FEAR

This is an often-cited statement made by
Privacy Intrusive Authoritarians.

Yet, Secrecy and Censorship are the hallmarks of
Privacy Intrusive Authoritarians.

So, if Privacy Intrusive Authoritarians
are doing nothing wrong, then...

Nothing to Hide, Nothing to Fear.

.

No Secrecy or Privacy for
Politicians and Senior Bureaucrats.

BEING WOKE MEANS

Having the ability to find Meaning and Fascination
from Poking One's own Faeces with a Stick.

SOCIALIST DEMOCRACY

A system based on voting for a thief,
that is willing to steal other people's stuff
and give a small portion of it to you.

TOTAL CONTROL

Governments, Politicians and Bureaucrats
are never satisfied with a little bit of Control.

Governments, Politicians and Bureaucrats
will not stop until they have Total Control.

Total Control.

The Socialist's Dream.

THE SOCIALIST'S SECRET

The Socialist does not take kindly
to being told what to do.

The Socialist is only interested
in forcing You into what to do.

All while patronisingly advising You
of the Socialist's haughty best intentions.

SOCIALIST GOALS

The Socialist claims to be the protector
of the lowest common denominator of
incompetence, ignorance and stupidity.

Whilst simultaneously working
to lower that benchmark.

The Socialist is Dumb.

So the Socialist requires that
everyone else be even Dumber.

A SOCIALIST FREE MARKET

The Socialist views a Free Market
as any Market the Socialist
does not 100% control.

But according to the Socialist,
when Socialist policy dictates
distort and corrupt the real Free Market,
then that is the fault of the Free Market.

The Socialist will never take responsibility
for the disasters that the Socialist creates.

Corporate Socialism = Corporatism.

TYRANNY'S FERTILE GROUND

Tyranny is much easier to establish within a society when,

1. Group Identity overrides Individual Identity, especially for larger collectives.
2. Accompanied by, unquestioning Gullibility and Obedience to perceived authority.

This is, Tyranny's Fertile Ground.



A BEAUTIFUL ACHING

T THE POLITICAL SOUL?

The Soul is not American.

The Soul is not Russian.

The Soul is not Chinese.

The Soul is not Christian.

The Soul is not Muslim.

The Soul is not Jewish.

Many of those that currently make reference to the Soul, have no idea about the Soul and have no idea what they are talking about.

Especially when referring to the Soul in Political or Religious terms.

Those that make reference to the Soul from a superficial Awareness perspective, are actually making reference to shallow aspects of the Psyche.

But because their Awareness is entangled within Physical and Emotional Awareness states, it gives the impression of being Deeply Meaningful.

It is not.

The Soul is not subordinate to any Political Framework or Religious Ideology.

How can it be?

Where are the factories that produce American Souls?

Where are the factories that produce Russian Souls?

A BEAUTIFUL ACHING

Where are the factories that produce Chinese Souls?

Where are the factories that produce Christian Souls?

Where are the factories that produce Muslim Souls?

Where are the factories that produce Jewish Souls?

The Soul existed long before any of these Political Frameworks or Religious Ideologies came about.

Political Framework and Religious Ideology are a Human mental construct.

They are not real.

There is nothing Deep or Meaningful about them.

They only create the illusion of being Deep and Meaningful.

The Soul is not Political.

The Soul is not Religious.

It never has been.

Human Idiocy is beyond measure.

A Rock is more *"Enlightened"* than the average Human Being.

EARTH

Planet of the Retards.

*Your lack of Awareness and Understanding
does not make me wrong.*

*What is the phrase
that may be applicable
for spiteful action?*

“Fuck around and find out.”

Okay?

“God Bless.”

ROOT CAUSE UNDERSTANDING

Superficial Consequences
have Deep Underlying Causes.

Superficial Consequences
cannot be resolved with
Superficial Understanding
and Superficial Solutions.

Superficial Consequences
can only be addressed with
Deep Underlying Understanding
and Deep Underlying Solutions.

PUBLIC RELATIONS

*“But you are not using your
“Public Relations” properly.”*

.

Ah, in case you have not noticed,
I’m not a Politician.

I have no interest
in pandering to Egos.

Besides, this is a process
of filtering out the Dregs.

CAN'T STAND THE HEAT?

The process of *“Enlightenment”*
becomes far more Merciless and Brutal
than what One may experience
by being offended over Words.

.

If the Heat from Words
is already too great,
best avoid the Kitchen,
let alone the Stove Top.

PRIORITIES

Maximum attention must be placed
on those that have at least some chance
of Awakening to a significant degree.

Placing energy and concern
into those with little to no chance,
is a waste of time and effort.

.

Time itself, is running out.

BEING RELIGIOUS MEANS

Never letting Truth get in the way
of One's own Self-Righteousness.

THE EGO PACK

The Sovereign Human Being
is not a Herd/Pack Animal.

The Human Ego
is a Herd/Pack Animal.

.

The Sovereign Human Being
has a Social Nature.



A BEAUTIFUL ACHING

A SOUL'S CATCH 22

A Soul must be able to turn up the Energetic Intensity to help resolve the barriers that inhibit Awareness from penetrating deeper into Being.

This is achieved by gradual increases to Energetic Intensity, allowing time for adaptation, then repeating the process.

An Ego may not react well to higher Energetic Intensity, which brings difficult and unpleasant Conflicts up to the surface for Awareness to confront.

There is possibility that the Ego could drive the Psycho-Biological Organism toward self-destructive behaviour or worse, as an out-of-control reaction to an unstable Psyche.

The higher the Energetic Intensity that the Soul can provide, the better the conditions for Awareness to penetrate deeper into Being.

However, applying more Energetic Intensity than the Psycho-Biological Organism is able to cope with, could be disastrous for not only the Psycho-Biological Organism itself, but for Others as well.

When the stability of the Psychological Body is delicate, the bandwidth between, not enough Energetic Intensity and too much Energetic Intensity, is quite narrow. This leaves the Soul with a very precarious predicament.

If a Soul plays it safe, Humanity languishes and deteriorates even further.

If a Soul goes for broke, it could potentially cause major destruction.

Such is the situation that a Soul, incarnate through the Earth Human species, has to contend with.

BEING WISE MEANS

That the Question of whether One is Able or Not Able
to take a certain course of action does not arise.

The Question that arises is,
Should, a certain course of action be taken?

In other words.

Being Wise,
is not a Question of
Able or Not Able.

Being Wise,
is a Question of,
Should.



A BEAUTIFUL ACHING

EXTRASENSORY PERCEPTION

If One has a functional sense of smell, then One is able to distinguish the fragrance of a flower, from the stench of a rotting corpse. Even though, One may not see or be able to determine where the source of these aromas emanates.

Without this sense of smell, One could be inundated with a plethora of scents, while being totally oblivious to their presence.

Developing deeper levels of Sensory Perception, which can recognise various Energetic traces, gives One the ability to identify forces and influences that may not directly or immediately be visible.

How does One develop such, "*Extrasensory Perception*"?

The same way that anything of Meaningful Value is discovered.

Through Deeper Self-Awareness.

OBSERVING TRUTH

Observe, What IS.

Not, what is expected.

.

Understand, What IS.

Do not interpret.

A BEAUTIFUL ACHING



A BEAUTIFUL ACHING

WHAT'S GOING ON?

Could the current Political Establishment
be deliberately destroying
the reputation of Legal Institutions?

All in an attempt to avoid being held accountable
for their own countless reprehensible crimes?

What could some of those crimes be?

Human Slave Trade.

Human Sex Trafficking.

Covert Breeding Programs.

Human Genetic Engineering Programs.

Biological Weapons Programs.

Human Organ Harvesting.

Paedophilia.

Perverse Sexual Rituals.

Ritualistic Adult and Child Torture.

Ritualistic Adult and Child Sacrifice.

Why are Biological Archetypes being Perverted?

Why is Sexual Perversion being Normalised?

Why is Individual Identity being Destroyed?

.

Why is Corporate and Government Media
not reporting on any of this?

Complicity?

.

Ah, don't worry about it.

Go back to watching your Sports Ball
and Superhero Movies.

This is all just
Conspiracy Theory
nonsense.

Or, you could
pray harder to your God
to fix things.

Surely that will work now,
even though it hasn't to this point.

"OUR FATHER, WHO ART IN HEAVEN..."

HUMANITY'S CHOICE

Either, the immune system of the Body
becomes Aware of and Resolves
any diseases that afflict the Body,
or those diseases will destroy the Body itself.

.

This is Humanity's Choice.

BECOMING EVIL

You fight against Evil,
but now, you have become Evil.

So, what has that achieved,
other than, perpetuating Evil?

CHASING FAIRY TALES

Forget Ideology.

Forget Theology.

Forget Philosophy.

Endeavour to Discover Truth.

.

Truth, most definitely is,
Stranger than any Fiction.

DEMORALISATION CAMPAIGN

“They’re trying to Demoralise us.”

.

So?

What are you going to do,
when you have the all Morale
beaten out of you?

FEAR IS NATURAL, HMM

Claiming Fear as Natural is similar
to claiming Pus is Natural.

Indeed, Pus is Natural,
in an infected wound.

Although technically true,
what is the point?

.

Nonsense masquerading as Wisdom.

CHANGE AND STABILITY

Outer Change and Turmoil
requires Inner Stability.

Inner Change and Turmoil
requires Outer Stability.

Inner and Outer
Change and Turmoil
will be Precarious.

Inner and Outer Stability
results in Stagnation.

.

During a period of
Extreme Outer Turmoil,
a Deep Inner Stability
is Imperative.

During a period of
Severe Inner Turmoil,
a Solid Outer Stability
is Vital.

ENTERTAINING DISTRACTIONS

Entertainment, Entertainment.

Give me my Mindless Entertainment.

I need my fix of Entertainment.

I need Entertainment
to Distract me from Myself.

Arrrrrgh!

NICE PERSON

You're a Nice Person.

But So What?

Nice People are a Dime a Dozen.

And yet, Imbeciles are Everywhere.

BE BOLD!

Yes, Be Bold,

Not Stupid.

WHICH HELL?

Refusing to Engage and Resolve One's own Inner Hell,
will contribute to the manifest Reflection of an Outer Hell.

Which Hell would you prefer to Experience?

Inner, Outer or Both?

.

Face and Resolve Your Demons,
before Your Demons Resolve You.

STRENGTH TRAINING

One does not become
Physically Stronger,
by avoiding
Physical Activity.

Similarly, One does not become
Emotionally and Psychologically Stronger,
by avoiding
Emotional and Psychological Difficulty.

SPECIAL SNOWFLAKE

“You’re So Special.”

.

You are not Special,
simply for breathing.

If you want to Be Special,
then Become Special.

First step to Becoming Special,
is to not be concerned
with Being Special.

In other words,
Drop the Bullshit.

A BEAUTIFUL ACHING



A BEAUTIFUL ACHING

THE SOCIALIST PROBLEM

The primary issue with Socialism, is that the Socialist is not really concerned with the welfare and well-being of a population.

The Socialist's main concern is with power and control.

Socialism compels conformity to social programs down the barrel of a gun; direct or implied.

The Socialist Problem is, that Socialism, is not voluntary.

As soon as social programs and safety nets become voluntary, they become a business, insurance and voluntary community programs.

These are all open to competing ideas and providers for these services.

Socialism is a forced monopoly.

Socialism is intended to create dependency.

Socialism is a one-size-fits-all approach to Individual and social issues.

But then, the inevitable question arises,

“What about the poor people?”

Socialism creates poor people.

Socialism cannot exist without poor people.

Socialism is constantly attempting to increase its supporter base.

It is easier to create dependency, with poor people.

Additionally, the funds for social programs do not come from Socialist governments, they come from tax payers.

The Socialist is very skilled at playing, "*The Hero of the People*", with other people's money.

UNIVERSAL HEALTH CARE

"*Universal Health Care*" is one such Socialist program that is intended to provide medical services to a national population at no direct cost to the Individual.

To see the consequences of this policy, One need only observe the general health levels of wealthy, western populations that implement such schemes.

There is no reason why genuinely healthy diet and lifestyle choices are not available to these people. Yet, poor fitness, obesity, chronic illness and degenerative diseases are out of control in these countries.

Why?

One reason is, incentive.

There is no incentive for Individuals to pursue healthy diet and lifestyle behaviours, because the resulting poor health is not a financial drain on the Individual.

If the Individual were to directly pay medical treatment costs for poor health choices, then the Individual would be incentivised to make better health choices.

Poor choices and behaviours need to bestow meaningful consequences for changes to take place. If no meaningful consequences are forth coming, then poor choices and behaviours are encouraged to continue.

Consider an Individual, with a neighbour that is a reckless and dangerous driver. So when the neighbour invariable has an accident, they demand that this Individual pay for the consequences of that accident.

What does One consider the response to this request would be?

This same scenario is reflected in those that are reckless and apathetic with their own diet and lifestyle choices.

Why should those that do make healthy diet and lifestyle choices, be forced to pay for the medical expenses of those that do not?

If these Individuals do not care enough about their own health to do something about it, why should anyone else?

Undoubtedly, the vast majority of medical costs incurred in the Universal Health Care systems of western countries, are induced from poor diet and lifestyle choices.

One need only examine the leading causes of death in western countries for this to be evident.

Another related point, in many cases, Socialist health advice is fundamentally wrong.

Poor health choices are the result of poor health education.

Socialist education programs are geared toward producing compliant citizens for the state. Rather than high quality, well rounded and intelligent Individuals for society.

The intent of this verse is not to be an all-encompassing repudiation of Socialism and Universal Health Care, but merely a catalyst to stimulate further inquiry. For there are many not-so-obvious and inherent issues with Socialism that others have already addressed.

An invaluable source on the topic of real free markets and the corrupting nature of Socialism, is the [Mises Institute](#).

*Assess a System by its Long-Term Results,
Not its Short-Term Intentions.*

HARD-WIRED PROGRAMMING

Ideology and Religion,
when indoctrinated into the young,
can create the false impression
of being not only voluntary,
but essential to Life.

REALITY AND ILLUSION

Principled Integrity is one thing.

Pursuing Ideological Purity,
is altogether different.

WHAT ABOUT THE SYSTEM?

Much talk comes about regarding what type of system is best for the world, rather than how to best develop higher quality Human Individuals.

No system is workable or sustainable with poor quality Human Beings.

Poor quality Individuals can only conceive of and work within, poor quality systems.

The quality of the Sentient Individual is the Foundation upon which a Society stands.

A population of high-quality Individuals, will find a high-quality way to organise themselves.



A BEAUTIFUL ACHING

T TURN IT UP!

Allow Intensity to Rise.

Let the Bullshit all Burn.

So when the Fires subside,
only Truth is left standing.

There is no turning away,
or winding things back.

Either One makes it through,
or One does not.

These, are the only options.

TOO MANY WARNINGS

The role of all Sentient species, is to Explore and Discover Truth.

Perpetuating Lies and Untruths on a large scale, will lead to the eventual destruction of the Sentient species.

Errors that are continually fed back into a system, will ultimately crash the system.

What part of this is so difficult for many to Understand?

Earth Humans are a failing Sentient species.

Will Humanity join the ranks of the failed?

Woke Ideological nonsense, is dwarfed by the Religious nonsense on this planet.

A BEAUTIFUL ACHING

Those peddling God and Religion, will be the primary cause of Humanity's downfall.

How many more warnings are needed?

Too many warnings have already been given.

.

There is not now,
nor has there ever been,
nor will there ever be,
a God.

CAUSES AND OUTCOMES

In a Complex System, an Outcome
may not directly point to its Cause.

A Cause can traverse many pathways,
before manifesting its final Outcome.

A SIMPLETON'S DILEMMA

The vast majority of Humanity
are such obvious Simpletons,
that they can barely recognise
what is right in front of their own face.

So what possibility is there,
for them to untangle a complex web
of Cause and Effect?

TEMPORAL UNDERSTANDING

“But Jesus spoke about God.”

.

Christ spoke in terms of
the Understanding of the time.

Or, was it the Apostles
that framed things in terms of God?

OPIUM OF THE MASSES

Religion, is the Opium of the Masses.

Paraphrasing Karl Marx

.

In this regard,
Marx was not wrong.

FEARFUL GOD?

If your God is the
All Powerful God of the Universe...

Why is your God So Secretive?

Why is your God Hiding?

What is your God Afraid Of?

EXHUMING SUBSTANCE

There is not Substance,
without Difficulty.

With Difficulty itself,
being no guarantee,
of Substance.

.

Just because One mines for gold,
does not guarantee One will find it.

Much is dependent on
Where, When and How
One mines.

IDIOCRACY

“We’re heading toward an Idiocracy.”

.

Too late, Humanity is already there
and, has always been there.

WHAT KIND OF FOOL?

One is not a Fool for being Wrong.

One is a Fool when exposed to
facts and reasoning to the contrary,
yet still refuses to acknowledge Truth.

One is a Despicable Fool,
when resorting to attacks
on the messenger.

THE LIMITS OF A FOOL

When a Fool seems to reach
the Limits of Foolishness,
the Fool, quite often,
proves the impossible.

I DISAGREE

"I disagree with your opinion on "X" topic."

If what is being expressed is True, what does your Disagreement even mean?

Your Disagreement is a nonsensical irrelevance.

Your Disagreement is the equivalent, to Disagreeing with the fact that $2+2=4$.

But if what you say is True, how did you independently, through fact, logic and/or reason, come to your understanding?

Regurgitating old scriptures does not count.

A BEAUTIFUL ACHING

Because if what you say is True, you must be able to verify it independently.

If there is a Creator God of the Universe to be Worshipped, then that Understanding must be verifiable anywhere, at any point in time, by any Sentient Being.

Verifying and Understanding Truth, cannot be limited to a certain group of Individuals, thousands of years in the past.

The Bible is nothing more, than He-Said/She-Said stories.

*Two plus Two will always equal Four,
whether you Agree or Not.*

PRAYER VS MEDITATION THE REMATCH

PRAYER

God, you're so great.
God, you're just the best.

God, give me this.
God, give me that.

God, do this.
God, do that.

.

MEDITATION

Self-Reflection.

Self-Awareness.

THE DISEASE AND THE CURE

God/Religion is a Cancer.

Truth/Spirituality is the Cure.

.

True Spirituality is
Self-Reflection, Self-Awareness.

FOOLS NEVER CHALLENGED

Religion is the result
of Fools never being Challenged.

Thus poignantly illustrating the importance,
to Question and utilise One's Freedom of Speech.

.

Ego is often Resentful,
when its Belief is Challenged.

THE DANGERS OF GOOD INTENTIONS

Obstinate, Ego validating *“Good Intentions”*, that hinder Oneself or Others from experiencing valid hardship and difficulty, will be the invitation for Evil to provide unintended counter-balancing measures.

The risk ensuing from blind *“Good Intentions”*, is of One inevitably becoming a tool of the Evil they presumably resent.

Remember, Nazis, in their own eyes, were *“good”* Christians.

God’s favoured Country, God’s favoured People, destined to inherit Heaven on Earth.

The rhetoric is often the same.

Nationalistic Fervour entangled with Religious Righteousness, is the precursor to an inevitable blood-bath.

Those that proclaim their Country and/or Religion as being favoured by some God, should be considered Dangerous.

The most atrocious Evil
is always concealed,
with *“Good Intentions”*.

What better Intentions,
than Righteously Virtuous,
Religious Intentions?

*How often do Ignorant Good Intentions eventuate
into Disastrous Unintended Consequences?*

CONSIDERING MORALITY

Religious?

Ask yourself, is your Morality and Integrity solely founded in your Religion?

If your Religion were to vapourise, would that mean you instantly become a Murderous Barbarian?

Is the only thing preventing you from becoming a Murderous Barbarian, that thin veneer of Religion?

Has your Morality and Integrity no depth?

You may protest that your Religion is deeply felt.

No, it is not!

Of course, you regard it as deeply felt though, having never experienced the real depth of Awareness/Consciousness.

But this is like walking into a shoreline and getting your ankles wet.

If you have no experience or concept of anything beyond that, it may well feel deep and meaningful.

However, there is an entire Ocean that you have yet to confront.

Will you find True Morality and Integrity, when finally confronting this Ocean?

Or is it actually a case, of you only buying into a Religion, because of some falsely promised pay-off at the end?

RELIGIOUS DELIVERANCE

Some form of Religious Ideology
is the consistent thread
running through all recorded
Human history.

Behold, the World currently presented.

Whether supportive or reactionary,
directly or indirectly,
this is the World
that Religion has Delivered.

All manifest from a contrivance,
with no basis in Reality.

KILLING GOD

Killing God is not difficult,
since nothing is required
to kill that which never was.

Convincing a Fool
of being a Fool?

Now that,
is the true Alchemy.

But then, some Fools's powers,
are beyond any Alchemy.

SO, WHAT ARE YOU?

Q. So, are you Religious?

A. No, I'm not an Idiot.

Q. So, you must be Woke then?

A. No, I'm not a Retard.

NOT SO FOOLISH

To those that feel a little less Foolish
after engaging with [A Beautiful Aching](#).

.

Hey, Welcome!

Welcome to the club,
of the Not So Foolish.

We have all been
where you have come from.

GAINING SELF-AWARENESS

Self-Awareness is not a Religion.

There is nothing to be Worshipped here,
only Understanding to be Gained.

A BEAUTIFUL ACHING



A BEAUTIFUL ACHING

R REASON FOR BEING

Although the Teachings of the Buddha, Christ, Mohammed and many others, points to Profound Fundamental Understanding, the Teachings themselves are offered within a Specific Contextual Framework.

One cannot be removed from the Specific Contextual Framework by thousands of years and chasmic cultural differences, but still be able to accurately comprehend the True Meaning underlying these Teachings.

When removed from the Specific Contextual Framework by such a degree, the only way to Truly Understand the Teachings, is if One is already versed in Profound Fundamental Understanding. Which then renders the Teachings to a historical studies value.

If these past Teachings are presented to those lacking Profound Fundamental Understanding, in a contemporary setting, their True Meaning can be lost, misunderstood or deliberately misrepresented. Thus furthering the distance between contemporary understanding and the Profound Fundamental Truths forming these Teachings.

Therefore, the Teachings of the Buddha, Christ, Mohammed and alike, may serve no beneficial purpose in a Contemporary Contextual Framework. But instead, could be inhibiting, or even detrimental, in the establishment of Deep Foundational Understanding.

What is required then, is a Contemporary Contextual Framework, to present Profound Fundamental Truths for the establishment of Deep Foundational Understanding.

This is the purpose for which [A Beautiful Aching](http://abeautifulaching.com) is offered.

SELECTIVE DELUSION

Many Religious Individuals espouse
the virtues of Fact, Logic and Reason,
yet unquestioningly promote and glorify
the idea of a Santa Claus in the Sky.

Where is the Fact, Logic and Reason
for a Santa Claus in the Sky?

Or does Fact, Logic and Reason not apply
to their own particular brand of Delusion?

BASTARDISED RELIGION

The Buddha was not a proponent
of any Religion of the time.

Christ was not a proponent
of any Religion of the time.

Muhammad was not a proponent
of any Religion of the time.

But somehow, their Teachings
were Bastardised into Religions.

Why?

WHO MAKES THIS STUFF UP?

Did Christ pronounce
that his supposed birthday
must be celebrated?

No!

Did Christ pronounce
that him being crucified
must be celebrated?

No!

Did Christ advocate for any
of the nonsense that Christianity
comes up with?

No!

Then Who Makes This Stuff Up?

A SOUL'S FAILURE

A Safe, Unquestioning, Religious Life,
has a Soul expending significant Energy
for little to no return.

In other words, a wasted Life.

A Soul can only successively sustain
a limited number of such Lives,
before becoming detrimental to the Soul.

A FOOL'S FATE

The Religious are comparable to Retarded Apes
beating themselves in the face with a hammer.

No matter how well or how often
the dangers of what they engage in is pointed out,
they simply proceed to beat even harder
or grab a second hammer.

A Fool is Destined
to a Fool's Fate.

Such is the Nature
of a Fool.

UNMASKING GOD

Q. What is God?

A. God is Ego.

PROJECTING BELIEF

Seeing Truth
is not the same as
Projecting Belief,
then viewing the projection.

ECHO BIAS

The tendency to Believe
a certain perspective or opinion
simply because it is often repeated.

BEYOND CONSCIOUSNESS?

God is the fabrication of a degraded Psyche.

God is a hallucination of imagination.

God does not exist beyond Oneself.

God cannot exist beyond Oneself.

Why?

Because there is no,
Beyond Consciousness.

GREATER THAN ONESELF

*"It is important to be a part of
something greater than myself."*

.

What are you talking about?

What could be Greater than Oneself?

Any perception of Greater than Oneself,
is a perception of Greater than Ego.

Any perception of Greater than Oneself,
is not fully Understanding or Knowing
the scope of Oneself.

There is no,
Greater than Oneself.

THE PERFECT SELF-DELUSION

“I devote my life to following Jesus.”

.

What are you talking about?

Christ died almost two thousand years ago.

You know nothing about Christ.

You have no idea who Christ was.

So, what exactly are you, *“following”*?

All you have is stories about Christ.

Stories from which you have constructed
your own personal image of Christ.

An image of Christ which neatly
fits with your own particular delusions.

How Convenient.

Now Christ can be whatever you want him to be,
without any push-back from the real Christ.

The Perfect Self-Delusion.

*(Replace Christ with the Buddha, Muhammad
or the historical figure of your choosing.)*

MECHANISM OF CAPTURE

God/Religion is a Mechanism
to Capture Awareness
and direct it Outward.

The inertia then generated over time,
propels Awareness beyond Religion
and into all manner of perversion.

Meditation redirects Awareness Inward,
aligning its Homeward direction of flow.

CONSEQUENCE OF IGNORANCE

Ignorance is not Bliss.

Truth, always eventually
arises from its armchair
and makes itself Known.

ANCHORED IN DELUSION

Being Indoctrinated into Ideology or Religion,
has One Anchored in Delusion.

Being Anchored in Delusion,
means One is Resistant to Truth.

Being Resistant to Truth,
induces Remedial Measures.

Remedial Measures,
will ensure One takes notice.

SEEKING HAPPINESS

Seek Truth, Not Happiness.

A Life devoted to seeking Truth,
will find Happiness more often than not.

A Life driven by the search for Happiness,
is Begging for Morsels in a World of Paupers.

.

An Unhappy World,
is a Truth Deficient World.

REFINING CONSCIOUSNESS

A successful Life,
is a process where One

has all the Impurities
Beaten and Refined
out of them.

Until only
Consciousness
remains.

A NEW PARADIGM

Truth flooding into a Truth Deficient World,
will result in significant unrest and upheaval,
as it establishes itself, creating a New Paradigm.



A BEAUTIFUL ACHING

FICTIONS OF A HIGHER POWER

If One behaves in a Moral and Compassionate manner to appease a perceived, *“Higher Power”*, then One is not functioning from a source of True Morality and Compassion. One is behaving to gain favour from this perceived, *“Higher Power”*.

True Morality and Compassion, Do Not Seek Favour.

True Morality and Compassion, are a direct function of, True Understanding.

True Morality and Compassion, do not require a *“Higher Power”* to compel them.

One that cedes reasons for behaviour to a *“Higher Power”*, is a Fraud.

A God Complex, is an outgrowth of Ego.

A God Complex, is not the result of a repudiation of a *“Higher Power”*.

A God Complex, sees itself as a *“Higher Power”*.

God is Ego!

RELIGIOUS FACADE

In a world of Superficial Awareness,
when Religion has been cultivated
with a Moral and Compassionate image,
any Despicable Individual can simply claim
to be Religious, thus avoiding Deeper Scrutiny.

PRETENCE OF GOOD BEHAVIOUR

The Pretence of *“Good Behaviour”*,
is worth less than a rusty nail.

The Pretence of *“Good Behaviour”*,
merely creates a sweet Facade.

The Pretence of *“Good Behaviour”*,
is deficient of any Substance.

The Pretence of *“Good Behaviour”*,
induced by a *“Higher Power”*,
is a Contemptible
Self-Righteous Performance.

.

All manner of Perversion,
can be hidden behind a Facade.

Substance is Congruous,
from its Surface to its Core.

FLOURISHING EVIL

Why does Evil
Flourish in this world?

Because there is no
“Higher Power”
to Stop it.

It is up to Truly Moral
and Compassionate Individuals
to Resolve it.

Because Moral
and Compassionate Frauds,
have done nothing
but Ignore it.

GROUNDHOG DAY

If God Nonsense
was the Answer,
then God Nonsense
would have prevailed
long ago.

God Nonsense
is not the Answer.

God Nonsense
is a Perpetuator
of Evil in this World,
whilst Cloaking itself
in a Virtuous Garb.

IMMUNE FROM HUMOUR

*“Oh No! The Wokes are
making fun of the Christians.”*

.

Why are Christians,
or any other Religious Individuals,
immune from being made fun of?

If Ideological Nut-Bags can be made fun of,
then adults that believe in a Santa Claus in the Sky,
can also be made fun of.

.

So, you feel grieved
for being made fun of?

Cry Harder.

RELIGIOUS CULT

Religious Individuals,
often view those within a Cult,
as Crazy.

Those brought up in a Cult,
consider being part of the Cult,
as Normal.

Just like Religious Individuals,
consider being part of their Religion,
as Normal.

.

A little Self-Reflection
may be in order.

RELIGIOUS POLITICS

Religions gain Financial Support
and Political Power
in proportion to their following.

Therefore, popular Religions
become a useful tool
in utilising Political Power.

Now, not all followers
need to offer Financial Support,
but the big donors that do,
gain Political Power.

.

So, what could be the real purpose
for Religion?

THE SUICIDE BOMBER JOKE

A Suicide Bomber is recruited
with the lure of gaining a place in Heaven.

What a Joke!

First off, the Suicide Bomber
has damaged their own Soul
by committing suicide.

Secondly, they burdened their Soul
with all the Karmic Debt incurred
from killing innocent Individuals.

Recruiters of Suicide Bombers
are only able to attract Simpletons,
because only Simpletons would be
convinced with this level of nonsense.

.

The Suicide Bomber
should be considered a Joke.

MONSTERS MAKING MONSTERS

Monsters Create Monsters,
as a Reaction to being Monstrous.

Monsters Require Monsters,
as Justification for being Monstrous.

Monsters Killing Monsters,
will Destroy the Whole World.

.

Weak Individuals, are the ones
that become Monsters.

With the most Wretched of Monsters
hiding behind Government,
enacting Despicable Deeds.

FITTING GOD INTO INFINITY

Many, including these writings,
have stated that each
Sentient Individual
is a Direct Expression of
Infinite Consciousness.

Given that the case,
where does God fit into this?

Where does God fit into Infinity,
if you yourself are Infinity?

Because there is no,
Beyond Infinity.

COULD IT BE?

Could it be, that the reason the world is being driven into Depravity and Perversion, is
so Religious Zealots can then claim justification, to silence their Heretical Detractors?



A BEAUTIFUL ACHING

MOTLEY MUSINGS

Presented here are a collection of musings that may be of value, but did not manage to find a core verse to call home.

ADVERSE BENEFITS

*Great Minds
Survive
Bad Training.*

Paraphrasing Anna Freud

.

Great Souls
Transcend
Great Difficulty.

EXPOSING FRAGILITY

When One is offended over a word,
they are not demonstrating how strong they are.

They are revealing how fragile they are.

NICE, BUT SO WHAT?

Simply playing a *“Nice Person”*
is not the overriding quality attribute
of the Human Individual.

SULKING AGAIN?

*“Did my words give
your fee-pees a boo-boo?”*

.

Behave like a sulking child.
Be treated like a sulking child.

THE LAST RESORT

Once the use of force is chosen
as the method for resolving a Conflict,
it immediately negates all other options.

So it may be Wise to exhaust
all other possibilities first,
before resorting to the extreme choice.

.

Applies to an immediate, unavoidable physical threat

PACIFIST MEETS VIOLENCE

One may consider themselves a Pacifist,
for whom the use of force
may never be an option.

But what are they to do
when encountering Another,
that does not feel the same way?

*One is more likely to Hate
Another they have wronged,
than they are to Hate
Another that has wronged them.*

Paraphrasing Tacitus

INDULGING SIMPLETONS

“Explain it to me like I’m five.”

.

You’re an Adult.

Why do you have the
intellect of a five-year-old?

BALANCING STUPIDITY

There is no Balance between
two opposing Stupidities.

Stupidity is always,
just Stupidity.

DEPTH PERCEPTION

One cannot see the Depth within Another,
that they have not realised within themself.

THE LATEST BANDWAGON

Corporation: Let's jump on
The Latest Bandwagon
and make lots of money.

Several Moments Later...

Corporation: We jumped on
The Latest Bandwagon
and lost lots of money.

Hey, but us executives
still got paid obscenely well.

.

Corporate Thinking,
is anything but,
Original Thinking.

Corporate Thinking,
is an Overpriced Cliché.

PERSPECTIVE MATTERS

“You’re difficult to work with.”

.

Egotistical Imbeciles find me
difficult to work with
and rightly so.

Those of solid Character
and Competence,
will find it Pleasant
and Rewarding.

RAISING THE FUTURE

Bringing up and raising children,
is not about obsessively protecting
children from difficulty.

Bringing up and raising children,
is about preparing children,
to ably address inevitable difficulty.

Nurturing and cultivating
Psychological and Emotional resilience,
is vital for the development of children
in becoming proficient at resolve difficulty.

But to be successfully instil in children,
Psychological and Emotional resilience,
must first be inherent within One's Self.

.

Of course, this does not suggest
parents be cruel to children.

A LOSER'S ATTITUDE

*"If things get too hard,
I'll just take myself out.*

Because I don't want to suffer."

.

This is the problem with a
privileged Human Ego,
dependent on technological comforts.

No Resilience.

No Resolve.

Pathetic.

.

Those thinking there is no cost to the Soul,
for an ego that destroys the body,
are sorely mistaken.

An analogous description would be,
for a farmer to plant a crop
and then burn it before the harvest.

Obviously, continuing with this approach,
will be detrimental in the long run.

THE HEIGHT OF EGO

Suicide is the Height of Ego.

Ego would rather destroy the Body,
than have to continue to face the suffering.

.

Suicide is not necessarily Immoral.

Suicide is Stupid and Cowardly.

THE IDIOCY OF MANTRAS

A Strong, Courageous Individual
does not keep telling themselves they are
a Strong, Courageous Individual.

A Weak, Cowardly Individual
tries to convince themselves they are
a Strong, Courageous Individual.

Thus, reinforcing that they are
a Weak, Cowardly Individual.

.
Mantras help reinforce
that which is not.

This is, the Idiocy of Mantras.

CLIMATE MANIPULATION

“Man-Made Global Warming”
is an Ideology of Self-Loathing
and Resentment toward Humanity.

A perfect vehicle of control
for any Authoritarian.

“Man-Made Global Warming”
has nothing to do with the
well-being of the Environment.

.
If the label, *“Global Warming”*, seems
a little too narrow in its definition,
the name can always be revised to
“Climate Change”, to justify all outcomes
as being Your fault.

CAUTION, ARTIFICIAL INTELLIGENCE

A Tool is only as Beneficial,
as the Sentient Intelligence wielding it.

An Imbecile with a Hammer,
may escape with only a sore Head.

An Imbecile with a Nail Gun,
could very well end up Dead.

COMING SOON!

A.I. Powered Voting Machines.

.

Is it becoming too hard to decide who to vote for?

Let the A.I. Voting Machine decide for you.

Guaranteed to get the right result, every time.

COMING SOON!

A.I. Powered Brain Chips.

.

What could possibly go wrong?

FUTURE BOOM INDUSTRY

Tattoo Removal.

SMASHING PEDESTALS

One should never allow themselves
to be placed on a Pedestal.

This is simply confining Oneself
to the area of the Pedestal.

Jump off the Pedestal
and smash it into a million pieces.

.

No Sacred Cows!

DRIFT AIMLESSLY

“Don't drift aimlessly. Focus.”

.

Correction.

There is nothing wrong with
spending time, Drifting Aimlessly.

Many a great discovery can be made
when venturing down unexpected paths.

.

Focus is not the Aim.

Awareness is the Point.

A more accurate expression
of this sentiment would be,

*“Don't Drift Mindlessly.
Maintain Awareness.”*

OPEN TO POSSIBILITIES

Exploration and Discovery does not have
a predetermined goal in mind.

IDENTIFYING AS WALLPAPER

Is the reason One covers their body in Tattoos,
so One can more convincingly Identify as Wallpaper?

So is Wallpaper now a Pronoun,
Gender or Sexual Preference?

It is so confusing.

ORDER OF OPERATIONS

A Baby cannot be Birthed
at the moment of its Conception.

A sufficient development period is required
for a successful Birth to take place.

Order of Operations, is Crucial.

OPEN BORDERS

If Individual Sovereignty and Respect for Private Property Rights is recognised as the Foundational Principle of Human interaction on a global scale, then Open Borders may become feasible.

Until this is the case, Open Borders will be a disaster.

MALIGNANT PARASITES

Q. How does a small country like the United Kingdom, specifically the British establishment, have such a significant influence on a major power like the United States?

A. A Parasite is often smaller than the Host.

DRUG LEGALISATION

The question of whether drugs should be legalised or not is the wrong question to ask.

The primary question that needs be asked is, why does One feel compelled into taking drugs?

Once that issue is resolved,
the question of whether drugs
should be legalised or not,
does not arise.

.

Superficial Questions
Do Not Resolve
Deep Underlying Issues.

CONTROLLED BREATHING?

What?

Do Not Control Breathing.

Get Ego out of the way,
Relax and Allow
the Body to Breathe.

.

Ego seems compelled
to Control everything.

PLAYING A ROLE

An Intelligent Actor/Actress can succeed
in playing a Stupid Character.

However, a Stupid Actor/Actress cannot succeed
in playing a Intelligent Character.

The attempt is often
cringe-inducing and cartoonish.

The current Western entertainment industry
is filled with Stupid Actors/Actresses.

.

A similar assessment can be made
for Writers and Politicians.

But given that the Human population
is mostly made up of Simpletons,
the Stupid appear as Geniuses.

I'm not a Simpleton.

*I can watch a quiz show
and get all the questions
about the Kardashians right.*

**

NARCISSISTIC NONSENSE

*"Narcissists don't love you.
They love themselves."*

.

Nonsense!

A Narcissist does not
Love themself.

That is why a Narcissist
demands Others Love them.

Anyone that actually Loves themself,
makes no such demands from Others.

.

Cheap, Superficial, Incorrect
Psychological “*understanding*”,
helps no one.



A BEAUTIFUL ACHING

A RETROSPECT

GRACE

Grace ventures into
the Bowels of Hell,
as easily as it bears
the Crown of Divinity.

*

STRENGTH

Not Invincible,
Just Fearless.

*

WISDOM

Wisdom takes root,
as Life's disappointments
become accepted.

THE TRUE WHOLLY TRINITY

Grace, Strength, Wisdom are not qualities that best exist in isolation to one another.

They are characteristics that synergistically compliment and reinforce one another.

These attributes are so intimate, that if two of the aspects are present, then the third is Expressed.

A BEAUTIFUL ACHING

- **Grace** and **Strength** together will Express **Wisdom**.
- **Strength** and **Wisdom** together will Express **Grace**.
- **Wisdom** and **Grace** together will Express **Strength**.

The True Wholly Trinity.

AN ANTITHETICAL PERSPECTIVE

[A Beautiful Aching](#)

founded on

Grace, Strength, Wisdom

.

An Ugly Delight

founded on

Petulance, Spite, Resentment

PERCEPTION VS REFLECTION

It is very unsettling when One
Perceives themselves as Beautiful,
but when confronted with a Mirror,
what is Reflected back, is Ugly.

(Metaphorically speaking)

TRUST

You are obviously
a product of the Universe.

Therefore, if the Universe
did not want You to exist,
You would not exist.

Given then, that the Universe
requires Your existence,
the Universe will hence provide,
for Your existence.

On condition,
You fulfil the requirements,
of a Sentient Individual.

.

What are the requirements
of a Sentient Individual?

Resolving Conflict
in a manner that contributes
to greater Understanding.

Resolve,
The Question Mark (?).

THE QUESTION MARK (?)

When contemplating or meditating on an Inner Conflict,
observe it as an open Question,
without preference or expectation for an Answer.

TRUST, NOT FAITH

Faith, is akin to Hope.

Faith and Hope imply a Fear
that certain events will not result in
any adverse effects on Oneself
or those One cares for.

.

Trust, is Powerful.

Trust recognises that the Universe
will unfold as it should
and One will play their part
to Confront and Resolve
any adversity that may arise.

SEEKING REWARD

Seeking Reward for *“good deeds”*
is a distorted perspective.

You are not a dog requiring
Reward for obedience.

You are Infinite Consciousness.
So who is there to Reward you?

When living the life of a Sentient Individual,
the Universe will provide for your existence.

With greater Understanding,
being its own Reward.

The entire Universe is your playground.

So what value are any of your trinkets.

DEEP THINKING

*A goldfish can only swim
within the limits of its bowl.*

Deep Thinking
is not possible within
Shallow Awareness.

Deep Awareness
is not achieved from
Deep Thinking.

Deep Thinking
is the result of
Deep Awareness.

Within a state of Deep Awareness,
the Thinking takes care of itself.

The state of Total Awareness,
has no room for Thinking.

.

The Imbecile and Divinity
share a common trait.

That is,
The Absence of Thought.

ONE'S UNIVERSAL CONTRIBUTION

When Learning,
One is not only helping
themselves to Learn,
One is also helping
the Universe to Learn.

Every different perspective
is a contribution to
Universal Understanding.

Thus furthering,
Universal Knowing.

TRUE VALUE

The Value of an Individual,
does not correlate to
the Value of One's bank account.

In fact, in many cases,
it is inversely proportional.

While those that Value their bank account
more highly than the Quality of themself,
are destitute in True Value.

As for those that Value nothing;
what can be said?

.

True Value is not something One obtains.

True Value is something One IS.

MAKE IT MEANINGFUL

Stone,
is just stone.

A Hammer,
is just a hammer.

.

Words,
are just words.

A Pen,
is just a pen.

.

Numbers,
are just numbers.

An Equation,
is just an equation.

...

To what effect Materials
and Tools are utilised,
is what Matters.

Make It Meaningful.

A STAGNANT RIVER

A Stagnant River
eventually becomes
Putrid and Odious.

Enabling it to flow,
gives opportunity
for it to Revitalise.

Similarly.

Tightly grasping Love,
sees it turn
Rancid and Repugnant.

Letting go of Love
and allowing it to flow,
gives it Life and Vitality.

TRANSCEND THE TOGETHER

It is Possible
for Love of Another,
to be Timeless.

However, it is Impossible
to be Together with Another,
Forever.

UNDERSTANDING'S MANY PATHWAYS

Conflict is a Catalyst
to draw out Understanding.

Teaching is a Catalyst
to draw out Understanding.

Love is a Catalyst
to draw out Understanding.

.

Indoctrination,
is a Superficial Coating.

Understanding,
is drawn out from the Void
to Create Substance.

ALGORITHMIC HIERARCHY

The Human Physiological Algorithm,

is Subordinate to

The Human Emotional Algorithm,

is Subordinate to

The Human Psychological Algorithm,

is Subordinate to

The Individual Soul Algorithm,

is Subordinate to

The Universal Natural Algorithm,

Is Observed by

Consciousness/Singularity.

.

Problems come about
when Awareness is Subordinate to
the Human Psychological Algorithm
or Shallower.

The Deeper Awareness Resides,
the more Stable Awareness **IS**.

DIVINE BIRTHRIGHT

Divinity is Your Birthright!

Religion attempts to lure you away from
and obscure the path to your Birthright.

There are no *“good aspects”* to Religion.

Religion cloaks itself
in the *“good aspects”* of Individuals,
to conceal its underlying motives.

Religion’s underlying motives are
subservience and subordination.

Your Birthright cannot be
subservient or subordinate
to anything.

Religion attempts to claim
Divinity and Spirituality
exclusively for itself.

As if Religion is the source of
Divinity and Spirituality.

Religion politicises
Divinity and Spirituality.

**Divinity and Spirituality
are not political.**

Religion is,
a despicable abomination.

WORTHY OF HEAVEN

Heaven is not Found in
the opposite direction of Hell.

Heaven is Discovered,
when One drags themself through
and out of the Bowels of Hell.

Only then, is One Worthy of Heaven.

.

Creating an External Hell,
only leads to destruction.

Journeying through
and transmuting the Inner Hell,
culminates into the state of Heaven.

.

If One is yet to encounter any Sustained
Deeply Meaningful Pain, Difficulty and Suffering,
then One has not yet Embarked on the Journey.

MATTERS OF LIFE

If One's own Life Matters,
then the Life of Another also Matters.

If the Life of Another does not Matter,
then One's own Life does not Matter.

THE MEANING OF LIFE

Q. What is the Meaning of Life?

A. The Continuous Discovery of Truth.

*Truth and Understanding
requires no Remembering.*



A BEAUTIFUL ACHING

R REFLECTIONS OF BEGINNINGS AND ENDINGS

For
Universe to End,
means
Universe did Begin.

For
Universe to End,
means
Consciousness did End.

But
Consciousness can not End,
because
Consciousness did not Begin.

Therefore
Universe can not End,
because
Consciousness can not End.

So
Universe **IS**,
because
Consciousness **IS**.

·
Consciousness
—
Universe

An
Inseparable
Eternal
Reflection.

CLAIMS OF BEGINNINGS

*To make the claim that the Universe has a Beginning,
One must first Define what the Universe IS.*

*If the Totality of the Universe cannot be Defined,
then how can a claim of a Beginning be made?*

Can One identify a single example of an Object, Item or Thing, with a traceable Beginning, whose existence is not derived from a pre-existing Object, Item or Thing?

If the Universe as a whole has a Beginning, then it was derived from an already existing Foundational Source.

The Universe as a whole must be a Reflection of that Foundational Source, because how can the Foundational Source manifest something that it is not?

If the Universe as a whole is a Reflection of this Foundational Source, then the Reflection has existed for as long as the Foundational Source has existed.

Time is a function within the Universe, because the Foundational Source cannot be governed by Time.

If the Foundational Source cannot be governed by Time, then the Universe as a whole cannot be governed by Time.

If the Universe as a whole cannot be governed by Time, then the Universe has no Beginning.

So, is this a Paradox or a Contradiction?

*The Universe is a
Reflection of Consciousness.*

*With the Universe
Reflecting back to Consciousness.*

UNIVERSAL FALLACY

How can the premise
of the Universe being both
Infinite and having a Beginning,
be accepted as legitimate?

Infinity has no Boundary.

So how is it not obvious,
that placing a Time Boundary
on the Universe
negates this premise?

UNIVERSAL HIERARCHY

The Uni-Verse is not
part of a Multi-Verse.

A Multi-Verse,
IS the Uni-Verse.

THE PROBLEM WITH SCIENCE

Science, is too busy investigating the pieces,
without Understanding the Whole.

Science, is Lost in the Labyrinth.

Science, cannot see the Forest for the Trees.

*Profound Truths are Discovered
at the Boundary Layer of
Science and The Mystical.*

COMPREHENDING EXISTENCE

Time and Space exist,
to separate Everything from happening
all at one Time, all in one Spot.

.

Q. How long does it take
to Explore all of Infinity?

A. Eternity.

GLIMPSES OF ETERNITY

A Death at every
Outward Breath.

A Birth at every
Inward Breath.

With Glimpses of Eternity,
found in the In-Between.

FROM ZERO TO INFINITY

Zero, is the Source of Infinity.
Nothing, is the Source of Everything.

Infinity, does not exist without Zero.
Everything, does not exist without Nothing.

Infinity, is the Reciprocal of Zero.
Everything, is the Reciprocal of Nothing.

Singularity, is Zero and Infinity.
Singularity, is Nothing and Everything.

Singularity, is the Source of Itself.
Singularity, is the Whole of Itself.

Singularity, Manifests as Duality.
Singularity, Transcends Duality.

*Zero has no Boundary,
because it has no Form.*

*Infinity has no Form,
because it has no Boundary.*

THINK BIG?

No.

Allow Awareness
to Occupy and Encompass
both Zero and Infinity
at the same time.

At this point Discover,
True Consciousness.

NEVER-ENDING NOTHING

"Nothing Ever Ends!"

Not True.

Everything Always Ends.

.

The Nothing, Never Ends.
The Everything, Never Ends.

But everything else, Ends.

.

There will Always be, The Nothing.
There will Always be, The Everything.

MISPERCEPTIONS OF FATE

Fate is not a case of,
what Should or Should Not be.

Fate, is a case of,
It IS,
What it IS.

RESILIENCE

Consider spending years
dragging yourself up a mountain,
toward a cloud layer that presumably
obscures the peak.

But upon breaching this cloud layer,
it is apparent there is no peak insight,
only another cloud layer,
which is twice as far away
as the distance just crossed.

Now image what it is like
going through this scenario,
over and over again.

.

Would you give up?

Could you give up?

WHY DO I DO THIS?

Because I want to Live in a World that is Better,
than the one there is now.

Because I want to Engage with a Humanity
that is Stronger, more Creative, Intelligent, Insightful,
Honourable, Compassionate and At Peace,
then the one there is now.

Because I want to leave behind a World
that is Exceedingly More Fulfilled,
than the one I entered into.

And the only way that this can happen,
is if I AM those things I want to see.

.

My Reasons are Selfish.

CREATION IS

Creation need not a Church,
for Sun to Awaken the Day.

Creation need not a Religion,
for Rains to Quench the Earth.

Creation need not to Worship,
for Waves to Dance on Oceans.

Creation need not a God,
for Stars to Dazzle the Night.

.

Creation,
absent all these things,
will still always be,
Creation.



A BEAUTIFUL ACHING

CREATION OF THE FIRE BLOSSOM

A CURIOUS SPECIMEN

This floral enigma is bestowed a dual horned flame,
based within the receptacle of the flowering bloom.

With these flickering flame tips twisting in helical form,
reaching up and convening at the crown.

Each floret expresses an alluring appeal,
Captivating from a distance, Agonising on contact.

However, when engaged with in a manner
of pure Sincerity and Gratitude, the sensation that ensues
Transcends the past, Transcends the future,
Transcends all that ever was and all that ever will be.

Resulting in a Peaceful Content, that opens the eyes to Eternity,
anchoring them in this irresistible Timelessness...

That IS.

The Fire Blossom is the name given to the logo or symbol which represents [A Beautiful Aching](http://abeautifulaching.com).

This verse endeavours to outline its design and construction processes, exploring the methods and techniques that were utilised in creating the end result.







DESIGN CONSTRAINTS

The underlying principle for this design is, **The Trinity** or **The Three**.

The only driving dimension to constrain the entire design is to be the overall size. All other elements are to be sized and positioned through naturally derived geometric relationships and proportions.

These geometric associations should be on a direct first level basis wherever possible, although this is not always practical. In some instances, implied proportions and relationships from other areas of the design may be utilised, so as to not over complicate the geometry.

Below is a key of the symbols that will be used to identify the types of relationship constraints which appear on the associated diagrams.

-  Tangent
-  Equal
-  Coincident
-  Numbered Entities Tangent
-  Numbered Entities Equal
-  Numbered Entities Coincident

CONSTRAINT ICON KEY CREATION OF THE FIRE BLOSSOM

GEOMETRIC SUPREMACY

Geometry expresses temporal relationships between Singularity's unique individual boundary states.

Mathematics defines and describes these Geometric relationships.

So Geometry encapsulates Mathematics.
Geometry is not a subset of Mathematics.

Simply put, the tree comes first,
the description of the tree follows.

Similarly, the spider does not need
Mathematics to construct its web.

*A Simulation,
uses Mathematics
to Define a World.*

*Reality, Creates the World,
which Mathematics
can then Define.*

STEP 1 - BASE CIRCLE

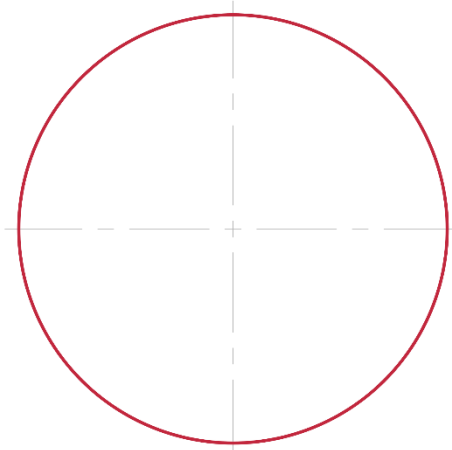

STEP 1
BASE CIRCLE

This is a fairly straight forward first step.

A BEAUTIFUL ACHING

It is simply, a circle.

This circle establishes the overall size of the image and is the only feature to be given a predefined dimension. It does not matter what the actual dimension is, because all else will be proportioned to it.

All other features and proportions will be derived from structural geometric relationships as stated previously.

STEP 2 - INNER RING, OUTER DIAMETER

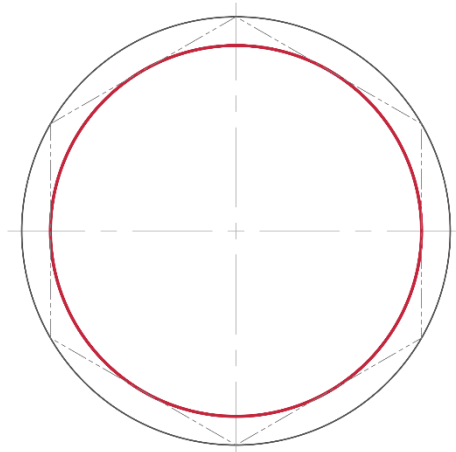

STEP 2
INNER RING, OUTER DIAMETER

This step gives an inscribed circle of a hexagon within the base circle.

The hexagon fits with **The Trinity** theme as six is a multiple of three.

STEP 3 - INNER RING, INNER DIAMETER

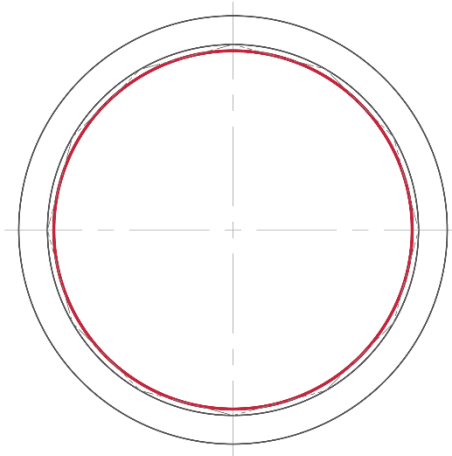

STEP 3
INNER RING, INNER DIAMETER

Next, the inscribed circle of a twelve-sided polygon is specified within the previously define circle.

The twelve-sided polygon also fits with **The Trinity** theme given that twelve is again, a multiple of three.

STEP 4 - BOUNDING DIAMETER

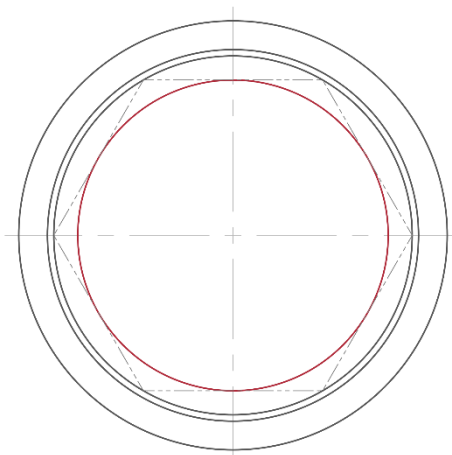

STEP 4
BOUNDING DIAMETER

Another inscribed circle is then generated from a hexagon within the inner ring.

This encloses the region where the main emblem is to be positioned.

STEP 5 - FLAME CONSTRUCTION GEOMETRY 1

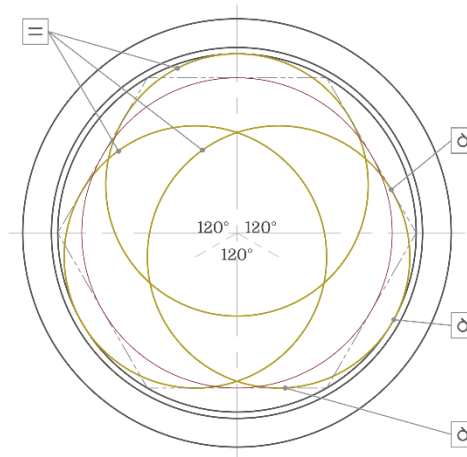

STEP 5
FLAME CONSTRUCTION GEOMETRY 1

Three circles of the same size, 120° apart are put in place.

The centre of the top circle is vertically coincident to the base centre.

The same tangent constraints apply to all circles.

STEP 6 - FLAME CONSTRUCTION GEOMETRY 2

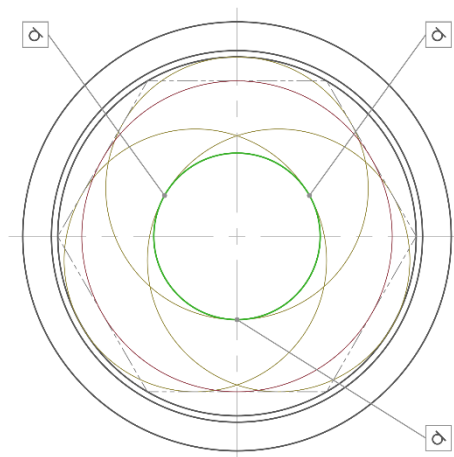

STEP 6
FLAME CONSTRUCTION GEOMETRY 2

The overlapping area of the three circles defines a central circle tangent to those three circles.

STEP 7 - FLAME CONSTRUCTION GEOMETRY 3

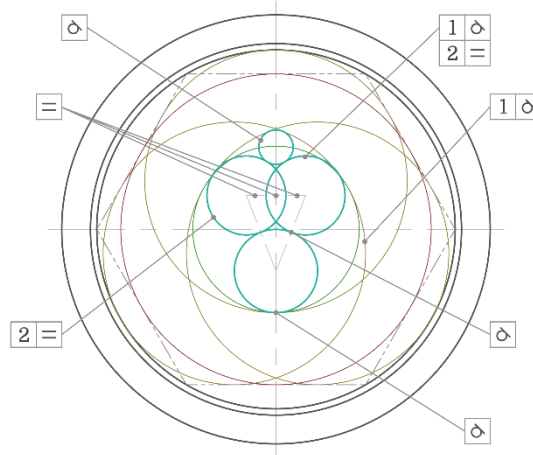

STEP 7
FLAME CONSTRUCTION GEOMETRY 3

A series of four circles is now draw, these will help delineate aspects of the flames.

Features and constraints are symmetrical about the vertical centre line.

The top smaller circle is tangent at four of its contact points.

STEP 8 - FLAME CONSTRUCTION

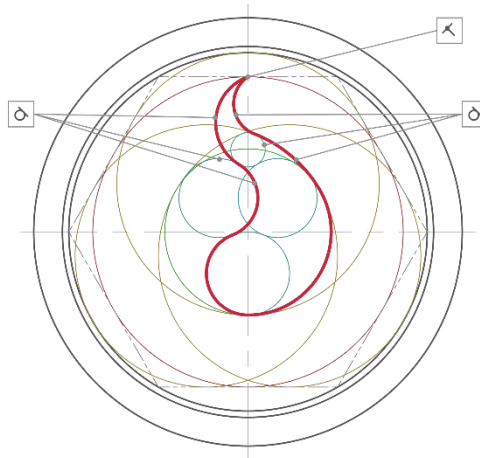

STEP 8
FLAME CONSTRUCTION

The arcs that make up the first flame can now be outlined from all the previous geometry, as shown above.

STEP 9 - FLAME INTERNAL CUT-OUT

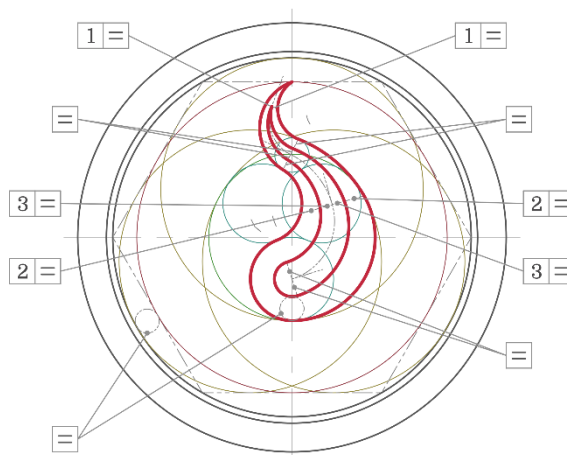

STEP 9
FLAME INTERNAL CUTOUT

The internal flame cut-out can now be made.

The full constraints on this diagram are not included, as this would present too much complexity for the purposes of this verse.

STEP 10 - FLAME MIRROR

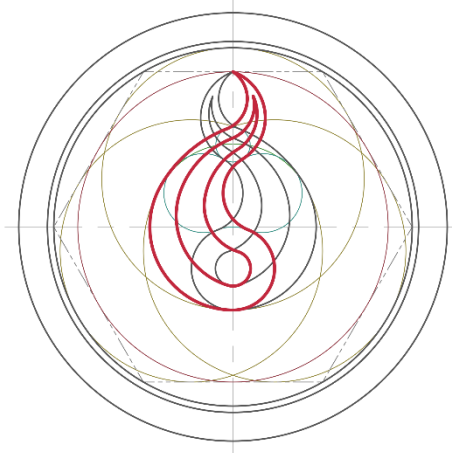

STEP 10
FLAME MIRROR

All the flame geometry is then mirrored to create the second flame motif.

STEP 11 - RECEPTACLE CONSTRUCTION GEOMETRY 1

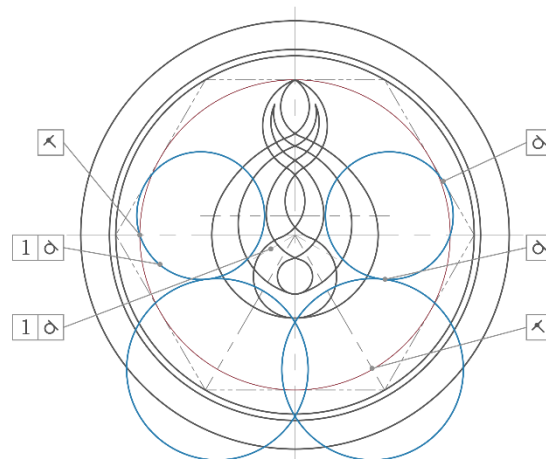

STEP 11
RECEPTACLE CONSTRUCTION GEOMETRY 1

Four circles are drawn to set the foundation for the receptacle.

Features and constraints are symmetrical about the vertical centre line.

STEP 12 - RECEPTACLE CONSTRUCTION GEOMETRY 2

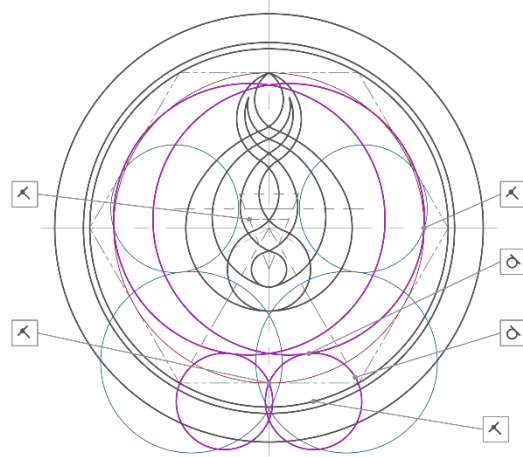

STEP 12
RECEPTACLE CONSTRUCTION GEOMETRY 2

Another four circles complete the setup for the receptacle.

Features and constraints are symmetrical about the vertical centre line.

STEP 13 - RECEPTACLE CONSTRUCTION

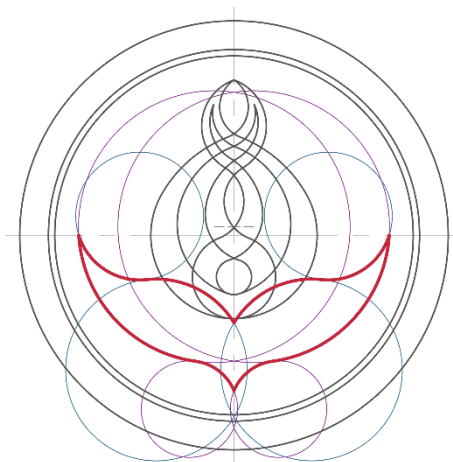

STEP 13
RECEPTACLE CONSTRUCTION

The outline of the receptacle is generated from the receptacle setup geometry.

STEP 14 - RECEPTACLE INTERNAL CUT-OUTS

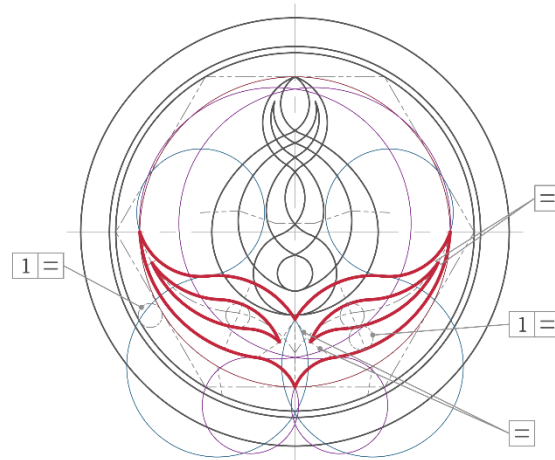

STEP 14
RECEPTACLE INTERNAL CUTOUTS

Internal receptacle cut-outs are drawn next.

The full constraints on this diagram are not included, as this would present too much complexity for the purposes of this verse.

STEP 15 - GAPS AND SEPARATIONS



STEP 15
GAPS & SEPARATIONS

Gaps in the required areas are now created, with these all being the same width as the inner ring.

STEP 16 - WEB CONSTRUCTION GEOMETRY 1

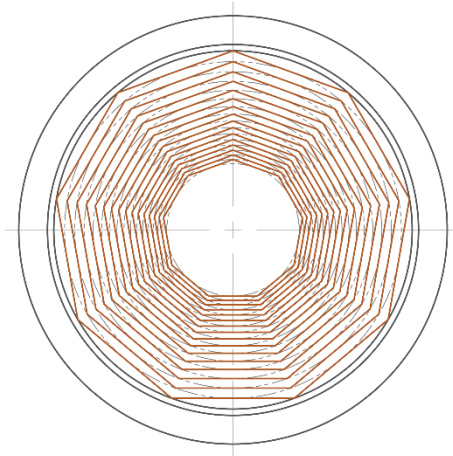

STEP 16
WEB CONSTRUCTION GEOMETRY 1

Web construction begins by setting up a symmetric convergence of a nine-sided regular polygon. Nine is again a factor of three.

STEP 17 - WEB CONSTRUCTION GEOMETRY 2

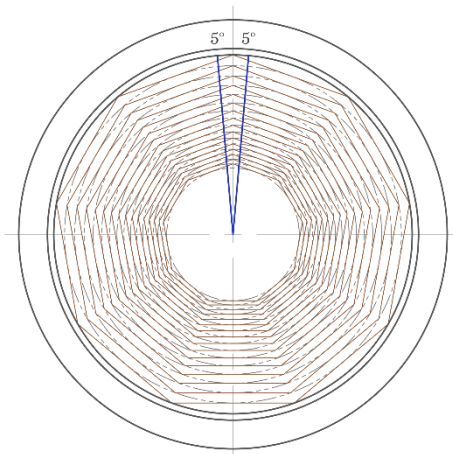

STEP 17
WEB CONSTRUCTION GEOMETRY 2

Two straight lines are then drawn from the centre out to the inner ring and each are 5° from the vertical.

STEP 18 - WEB CONSTRUCTION GEOMETRY 3

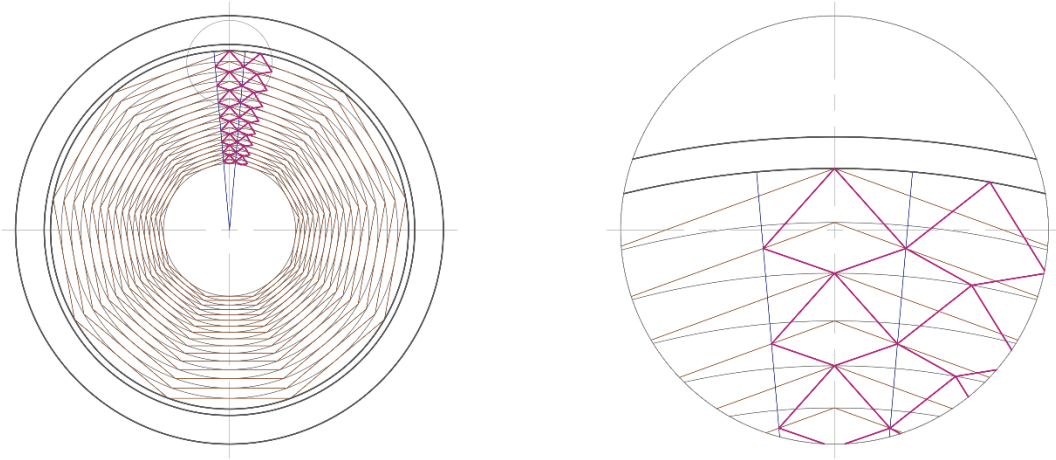

STEP 18
WEB CONSTRUCTION GEOMETRY 3

An inverted diamond shape is constructed down the convergent polygon pattern and then mirrored about one of the lines extending from the centre.

STEP 19 - WEB CONSTRUCTION GEOMETRY 4

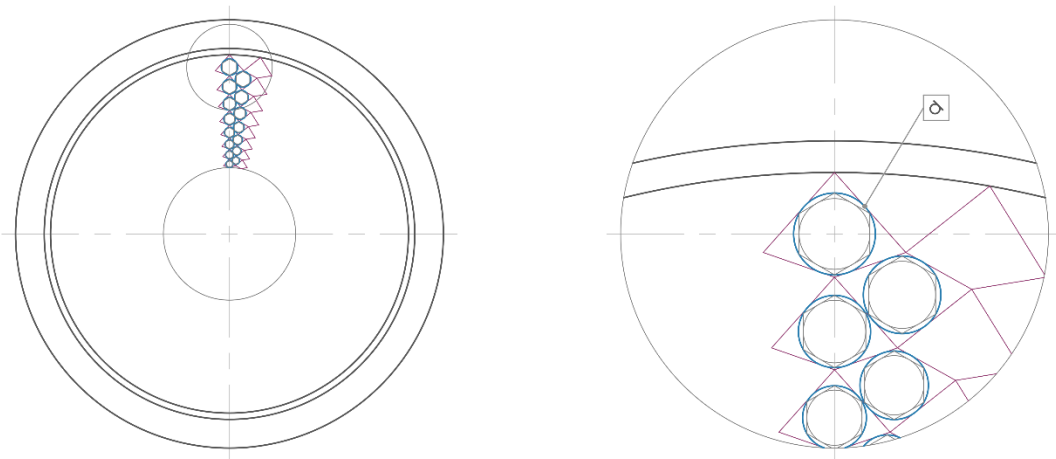

STEP 19
WEB CONSTRUCTION GEOMETRY 4

Within this inverted diamond shape, a circle is established by its tangencies to the sides of the inverted diamond. This becomes a circumscribed circle for a hexagon, which then implies its next inscribed circle.

STEP 20 - WEB CONSTRUCTION GEOMETRY 5

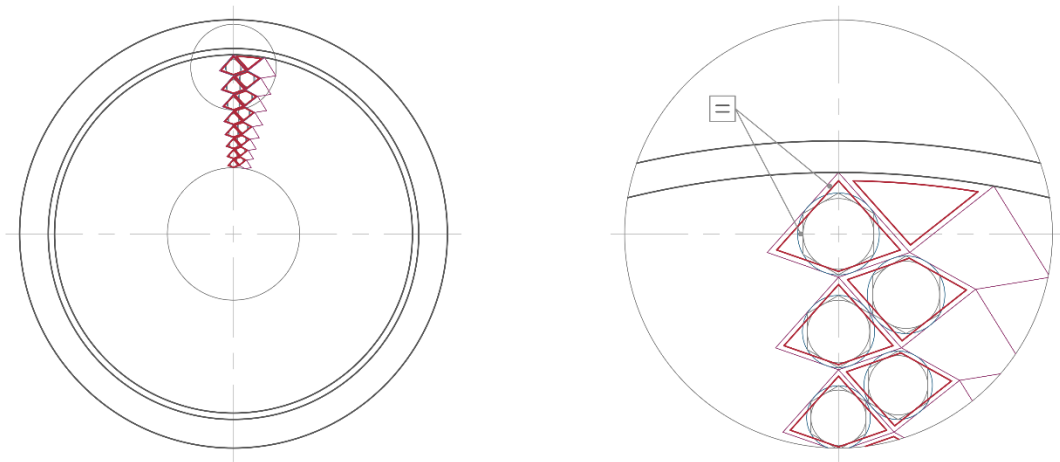

STEP 20
WEB CONSTRUCTION GEOMETRY 5

The lines of the inverted diamond shape are then offset inward by the distance between the circumscribe circle and the inscribe circle of the hexagon.

These become the geometric basis for the web.

STEP 21 - WEB GENERATION

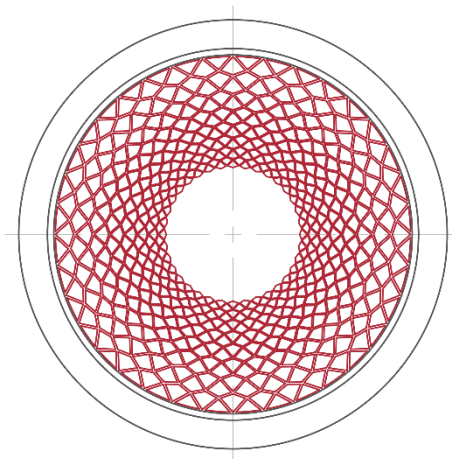

STEP 21
WEB GENERATION

This initial web geometry is then arrayed around the centre thirty-six times to create the web background.

STEP 22 - FINAL GEOMETRY



STEP 22
FINAL GEOMETRY

Displaying all the elements gives the full geometry for the Fire Blossom image.

STEP 23 - THE FIRE BLOSSOM



Filling in colour, adding additional text and effects, gives the Fire Blossom its resultant form.

*To those that feel Hurt, Angered or Offended
by anything presented on A Beautiful Aching...*

*Do you not Understand
what A Curious Specimen
the Fire Blossom is?*



A BEAUTIFUL ACHING

T THE GIFT

A BEAUTIFUL ACHING

When a Gift is Given
The value is not Found
In the wrapping, Packaging
Or ribbon you tie Around.

True beauty is Hidden
Beneath all the Art
And can only be Seen
Through the eyes of the Heart.

Playfulness, Cheek,
Like that of a Child,
Shine from the Depths
Of a passion that's Wild.

Vulnerability, Strength,
As expressed by a Flower,
Graciously lead to Your
Real source of Power.

How beautiful you Look,
Some may say from Afar,
But I see Inside
And know how Beautiful you Are.

A BEAUTIFUL ACHING

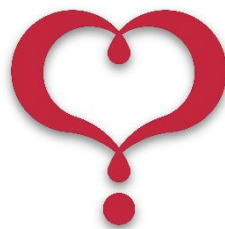

A Gift incurs no Debt.

When offering that which is Invaluable,
the only option available, is to offer it freely.

For there is not the wealth nor fortune in the
entire Universe, to adequately compensate its worth.

.

Humanity has been given
a Tremendous Gift.

Now it's time to Earn It.

*Surrendering to Infinity,
is not a defeated surrender.*

*Rather, it is
A Victorious Surrender.*

DISCOVERING POWER

My life, these writings,
are not about me
demonstrating my power.

They are about helping You,
Discover Yours.



A BEAUTIFUL ACHING

DEDICATION

To the One that is the catalyst and driving force
underlying everything presented on [A Beautiful Aching](http://abeautifulaching.com).

I have no words...

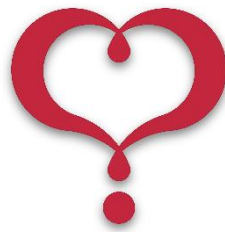

*If One can live through, survive and overcome,
the most extreme and deeply profound broken heart,*

*then there is no cosmic cataclysm
that One will ever find overwhelming.*



A BEAUTIFUL ACHING

APPENDIX B - WHISPERS FROM THE FORGOTTEN SERIES

Appendix B is a sampling of short stories from the Whispers from the Forgotten Series.



A BEAUTIFUL ACHING

WHISPERS FROM THE FORGOTTEN

Remember Kah Duhran.

Remember Who You Are.

...The Realm of Shadows.

Avoided by many.

Feared by most.

A place of untold mystery.

The domain of endless nightmare.

For the daring however,
adventures await.

Some pleasing and cheerful.

Others too painful to bare.

Regardless the risk,
discoveries are made.

Like echoes of memory
and reflections of possibility.

...

“Kah Duhran...?”

A term that resonates fascination.
A phrase that impresses upon silence.

Who are they?

What are they?

Where are they from?

.

A Teacher...?

A Guide...?

A Master...?

.

What role do they fulfil?

What part do they play?

...

“Emissary!”

Hmm.

Interesting indeed.
But meaning is vague.

An Emissary represents,
so whom do they serve?

Wisdom...?

Light...?

Knowing...?

...

"The Knowing!"

Emissary of The Knowing.

Curious still.

More questions spring forth,
than answers put to rest.

But wait!

...Faint whisper.

A word.

A place.

A ripple in time.

...

"Eorin...?"

Not quite.

What else?

Additions to this thread.

...

"Eorin Gah."

That's it!

A place long ago.
Name lost to the void.

A planet?

A city?

.

Maybe one?

Maybe both?

...

A worthwhile endeavour.
Possibilities flow.

Findings will be presented,
as unveiling proceeds.

So far little is revealed,
but a path has been set.

What morsels are known,
shall be summarised at the end...

DEFINITIONS

Kah Duhran – Emissary of The Knowing, Emissary of Wisdom.

The Kah Duhran – Emissaries of The Knowing, Emissaries of Wisdom.

Kah or **Ka** – Knowing, Wisdom or in some interpretations, Light. But Light in the Transcendence sense, not the Dualistic sense of Light and Darkness.

Duhran – The Emissary.

The origins of the Kah Duhran are unclear, but the first verifiable mention of them was from a planet that was known by its inhabitants as Eorin. With its capital being the city of Eorin Gah...



A BEAUTIFUL ACHING

FIRST K'DUHN

Kah Duhran never refer
to themselves as, Kah Duhran.

They do not deny it.
They do not confirm it.
They do not reference it.

But when it needs to be known,
their Presence will announce them.

DEFINITION

K'Duhn – A Kah Duhran teaching. Alternatively, an instrument or scenario for teaching.



A BEAUTIFUL ACHING

A PURE HEART

“GOHRASS!

We have captured Kah Duhran!”

The heavy throne room doors burst open. Gar Rog, appointed Seer from the royal court, dispenses with formalities in alerting the Viceroy of the added danger to an already desperate situation.

“What?!”

Some attendees to the emergency meeting growl from the back of their throats as part of a nervous defensive reflex.

“And you brought them here?!”

Imperial guards follow the oracle into the legislative chamber. Two pair supporting poles between them, suspending the couple by their wrists, which also happen to be bound behind their backs. With tearing pain electrifying shoulders, having been twisted in this abnormal manner.

“Who are they?”

“A farmer and his wife from Temek.”

Harsh treatment since capture is clearly evident on both, as blood stained clothes are reduced to mere rags.

Gar Gohrass, Viceroy of Rohur, standing under an immense circular, domed skylight, turns and faces the procession as they enter the stone assembly hall.

“What makes you say they are Kah Duhran?”

The Viceroy plainly displeased with the interruption.

“And why would Kah Duhran be in a sewer town like Temek?”

The guards stop, just inside the wooden arched doors. Rog proceeds into the ring of stone columns which provide support for the glass canopy above.

“There is talk of them spreading subversive lies against the royal rule.”

Both having to elevate their discussion due to the constant drone which is now getting noticeably louder by the hour.

“That does not make them Kah Duhran, that just makes them insurgents.”

An uneasy chatter from bystanders begins, complementing the already ominous background noise.

“Why are you wasting my time with such nonsense? Are you not aware that we have more pressing concerns to deal with?”

Agitation from all parties is palpable.

“I am a Royal Seer and I say there is more to these two than just being pesky insurgents.”

Gohrass relents, his impatience demanding a hasty resolution.

“Fine. Bring them!”

Rog summons the pole bearing guards, which then unceremoniously dispose of the humanoids just within the perimeter of the hefty pillars, not too far from where the Viceroy and his consul are standing.

“The male is Aros. The female, Kei-Len.”

Aros stood first, hands still bound, his body relieved that the strain on weary shoulders had eased.

Behind her husband, Kei-Len rises slower, exhaustion more visible. Momentarily placing her forehead on his back, before gaining composure and taking a step forward.

“Alright?”

Aros asks softly, when the sensation of his wife’s resting head gave indication to her discomfort.

Resilience returns to her face, as Kei-Len takes a breath and nods in acknowledgement.

“They do not look much to me. Have you interrogated them?”

The Seer now irritable with the Viceroy’s misgivings.

“We tried!”

Gohrass looks over Aros.

“Are you Kah Duhran, farmer?”

No response.

“We have not been able to get anything out of him.”, Rog interjects, attempting to hurry the process.

“Well rip it out of his mind, you are the Seer after all!”

“I have not been able to do that. That is why I suspect they are Kah Duhran.”

“What about her?”

“Her as well.”

“What kind of incompetence does the Royal Court send me?”

Snot ejects from the mystic’s snout as he snarls back with a grimacing stare, not willing to risk any greater show of petulance.

Now increasingly agitated, Gohrass turns his attention back to Aros.

“Did you bring that destruction upon us?!”

A BEAUTIFUL ACHING

Pointing up through the skylight to a now sizeable orange ball, wagging its tail, contrasting the night sky.

“No.”, Came the reply.

“Do not toy with me, sewer farmer.”

“If you are Kah Duhran, then I demand you stop that abomination. NOW!”

Aros says nothing, as he stares back at the hulking seven-foot lizard, dressed in red tunic, embellished with the emblem of his royal order.

Kei-Len meanwhile, looks around the room, making note of the rock pylons leading up to the round, transparent covering, which frames the fireball almost perfectly. Giving the impression of an eye with a dilating fiery pupil.

Gohrass notices her inquisitiveness.

“I do not have time for this.”

“Continue to play with me and I will squash this woman of yours like a bug.”

Discovering a semblance of her normal vigour, Kei-Len allows her natural feistiness to surface.

“Your words are hollow.”

Eyes widening and displeased with such insolence, Gohrass shoots back.

“What?! Why does your woman speak for you?”

Again, no response from Aros, as he looks at her, curiously.

“Are your threats intended to intimidate children?”, Kei-Len continues, seemingly a little too comfortable, given the current circumstance.

“This woman annoys me. I will squeeze her head like a puss filled infection and you will have front seat for the show!”

"We have watched each other die a thousand times.", she states. As if it were a mere trifle.

Aros, with an increasing sense of dread, feels the need to underline the seriousness of the situation.

"Yes, and each time more painful than the last.", addressing her.

...

...It took a moment.

But as Kei-Len looks back to him,
a tear soon forms.

Along with a discrete, surrendering sigh.

Whilst reliving the sombre truthfulness
within his piercing statement...

...

"ENOUGH!"

A reptilian paw grabs her by the throat, slamming her like a doll against the nearest stone pillar.

"Bind this witch to the column!"

"You have one last chance, farmer.", Threatens Gohrass.

"If you are Kah Duhran, then end that. NOW!", Referring again to the menace in the heavens.

"If you are not Kah Duhran, then you are both wasting my time."

"Which will it be?"

A BEAUTIFUL ACHING

Aros locks eyes with Kei-Len. She knew what the response would be.

“ ... ”

“If that is your choice.”

With the rock structure at her back providing the necessary resistance, a fist collapses Kei-Len’s rib-cage and a hand then reaches in, crushes and tears out her heart.

A roar erupts in the throne room.

The excitement of the audience overflows with enthusiasm, as the brutish display gives temporary distraction to the fate descending upon them.

...

...Aros, just stood.

Eyes still anchored on Kei-Len.

Watching her life drain away, like the emptying of a ruptured container.

But Awareness, is unmoved.

He sees her eyes slowly close, as blood streams from her chest.

But Awareness, does not waver.

He watches her head slump forward, restrained at the neck.

But Awareness, remains resolute.

He suffers this scene being burnt to his memory.

But Awareness, is unflinching.

He senses his legs almost buckle beneath him.

But Awareness, will not run.

He feels his gut being twisted and ripped apart.

But Awareness, will not hide.

He notes his heart being crushed by an ethereal hand.
But Awareness, does not falter.

He accepts a tsunami of panic wash over him.
But Awareness, remains steadfast.

He discovers new levels of pain, as each time before.
But Awareness, will not submit.

He notices Gohrass and his frenzied red eyes.
But Awareness, does not surrender.

He perceives the blood-lust rage of the assembled horde.
But Awareness, is unyielding.

He hears the loudening roar that envelops it all.
But Awareness, remains enduring.

Given these horrific events and his agonising reaction,
Awareness does not stagger, not even in the slightest.

Awareness, remains Still...

...

Gohrass stands directly before him, sneering, smirking, pleased with what he has done.

“This is your doing. This is what you chose.”, he mocks.

Now witness to Kei-Len’s heart being thrust into his impassive face, Aros fixes eyes on the Viceroy.

Blood drips from Gohrass’s silver-green jaw, as every last piece of the organ, is spitefully devoured.

A BEAUTIFUL ACHING



A BEAUTIFUL ACHING

S SECOND K'DUHN

What defines Kah Duhran,
is not how many enemies One can slay.

Instead, it is the calm and resilience One embodies,
when facing a merciless and tumultuous onslaught.



A BEAUTIFUL ACHING

P POISON FOR THE WICKED

...

...Dusk breaks in the sky, as sun begins to ascend.
Light breaches the dark, thus ending this dire night.

Dry sloping terrain, is proving arduous to climb.
As the heavens still roar, while fury yet swirls about.

Gravel slips underfoot, with little strength to resist.
Knees baring the impact, upon surface hard as stone.

Pain erupts up his legs, but he holds on to her firm.
No chance of letting go. No possibility of her fall.

Wrapped in a red tunic, is her upper body and her head.
Blood covers all their clothes, whatever remains of them.

Rocky outcrop on the hillside, is the objective to be reached.
Seems impossible to consider, this destination to complete.

Distance covered without effort, some dozen times or more.
But given current factors, achieving once would now take all.

A meagre moment just to rest, that stretches out to many.
However, even standing, is the difficulty to address.

Is this the way things are? Is this the way it is to end?
If so, so be it. Because there is nothing, that is left...

...

Feeling a hand grasp his shoulder, Aros opens dust covered eyes to see what phantom has come for him.

“Can I assist you master Aros.”, are the words that emanate from the deep, familiar voice.

“Brohk!”, is the surprised response. The name almost sticking in his dry throat.

It takes a while for his body to regain some semblance of life, since collapsing in that place for what may have been an hour or even more.

“Would you like me to carry her?”, offers the Suhn Gar.

A sense of relief and renewed determination rises, as vitality sluggishly returns. The gesture of support stokes a flame in Aros that had almost burnt itself out over the course of the last few hours.

However, amidst his senses reviving, the perception of who he is carrying and the reverberation of earlier events surfaces again, giving him pause. Processing matters momentarily, in some part at least, simply to carry on.

Wanting to now stand, his numb legs seem unable to comply, but is quickly caught as he stumbles backwards in the attempt.

“Steady there. Are you sure I cannot take her?”, Brohk repeats his offer.

“I will carry her please.”, Aros advises.

“Can you help us get to those rocks?”

Gar Brohk, a roving work hand that often travelled to Temek and the employ of his two roadside discoveries, presently finds himself bracing Aros in his labour of carrying Kei-Len’s body. Fortunately, Brohk’s large frame aids in shielding them from the dust and sand being hurled about continually as they trudge.

With blood flow returning to his legs, Aros is walking on his own upon reaching the sanctuary of the megaliths. Although the distance was not great, the time and effort it took to get there seemed far more than would be necessary on any other day.

“Never thought I would be so relieved to see a Suhn Gar.”, acknowledges Aros in gratitude.

The nest of boulders atop the dry, arid rise provides gratifying, if only somewhat tolerable shelter from the prevailing wind and noise. The city below, obstructed by the murky haze, is difficult to see other than in silhouette. Occasionally breaking into clearer view when the gusts briefly subside.

One of the larger masses in this rock-pile projects from the ground and features a recess along its broad base. Consequently leaving a small nook, that affords some cover, within which Aros lays out Kei-Len's body. Ensuring that her resting place is as well prepared and comfortable as possible.

Finally satisfied that he has done all he can, he sits in front of her torso, leaning against the stone face, offering a little more protection to her from the increasingly tempestuous elements. Brohk takes a place beside him, concealing Kei-Len's legs, which Aros quietly appreciates.

"So how did you come to be on this road? My last hearing was of you and Kei-Len being taken by the Seer's guards."

Brohk obviously intrigued by the developments.

"No doubt he presented you to Gohrass as a trophy."

"He did.", came the concise reply.

"And you manage to escape the stronghold?"

"Well, there was a commotion in the throne room."

"Your doing?"

"No, Kei-Len's."

"In what way?"

"A pure heart is poison for the wicked.", Aros reflects. Acutely anguished by the preceding night's affair.

“Hmm, feisty to the end.”, muses Brohk. Recalling Kei-Len’s sometimes prickly, but always straightforward manner.

A sombre tone lingers as the two merely sit, not speaking at all, watching the city below come in and out of view, governed by the dictates of the wily squall. Occasionally glancing at the sky to register the peril’s pending arrival. Keen to have it done.

“Is that red tunic a prize?”, Brohk enquires.

“Unintentionally, it seems.”

“It pains me that some of my people have surrendered to such wickedness. It was once not like this.”

“You do not have to be burdened by the actions of others my friend.”

Aros reciprocates a hand on Brohk’s shoulder, again showing appreciation for his sorely needed assistance.

“I understand. But it is not the actions of others that burdens me, it is the inaction of those that did nothing to stop it.”

Accounts must now be squared and many innocent will pay the price, as has your Kei-Len.”

Brohk looks skyward, indicating to the fiery incomer approaching collision.

“This is the grief that troubles me.”

Tapping Brohk’s shoulder, Aros can offer no words for him that are able to ease the current reality. A sorrow that taxes them both.

With the conversation petering out, a reflective mood descends. Aros reaches back and finds Kei-Len’s hand. Feeling compelled to hold her in whatever small way he can, given the time remaining.

The roar grows louder, thick like molasses in the air. Even the ground beneath and the rocks at their back resonate in permeating severity. Gale gusts churn the dust, sand and gravel making breathing a real task, even through the scant coverings available.

“It is almost upon us.”, Brohk yells. His final words.

Intractable noise ceases when the thunderous and piercing barrage ruptures even protected eardrums, thus relieving the two of hearing. Although the reverberations continue to be felt through the terrain and surroundings objects.

A wind shift brings the unrelenting furore head on, with no possibility or point of moving. Resulting in dirt and sand being blasted directly at them, disintegrating clothes and ripping away flesh.

The sustained onslaught most certainly means that survival is unlikely before the moment of destructive impact. At this stage, the meteor ejects such a massive wave of intense, rolling fire that the heat generated manages to melt the surface of the boulder they lean against.

Which, in all likelihood, would indicate that their bodies are engulf and vaporised, in an instant.



A BEAUTIFUL ACHING

T THIRD K'DUHN

A Pure Heart
is Poison for the Wicked.



A BEAUTIFUL ACHING

T THE FINAL CALL

THE INTRODUCTION

The Silent Stillness of Space is disturbed by an awakening Presence.

An enormous craft in stationary orbit, around the blue planet below, was the origin of the beacon that summoned the ancient cosmic Titan from its hibernation. Which to this point, extended across several celestial life-times.

The sense of this Being has no source, only a profound emanating Existence.

A solemn reverence arising from those on board, provides the invitation for the Entity to infuse itself through the vessel and coalesce in part, inside the living quarters occupied by the esteemed instigator of the call.

Framing a portion of the cloud speckled world, a large oval-shaped viewing portal opens out opposite the entry. Light reflecting from the planet's surface, into the dimly lit accommodations, silhouette's the hooded Emissary standing within its border.

"Welcome Master."

Was the opening communiqué, not spoken, but succinctly expressed through channels that precede vocalisation.

"I have often questioned whether we would ever be in Presence again.", Ardath conveyed, to the formless Awareness behind him.

"Master? You still address this Soul as, Master?", came the response.

Impactful in its delivery, even with impressions of it being restrained so as not to overwhelm the recipient.

A BEAUTIFUL ACHING

“You have come to be Master yourself, long before this Soul’s dormancy. So why still refer to it as, Master?”

Ardath turns to face the sparsely furnished landscape of his temporary abode. Placing his left hand on his chest and bowing slightly in adoration.

“How can I not?”

The One to Find me. The One to Teach me. The One to Guide me.

So yes, always respectfully, my Master.”

“The honour is noted old friend.”, came the appreciative reply.

“In any case, the dormancy of this Soul was ended for good reason One trusts?”

“Indeed.”

“What is this world below here? There is unfamiliarity with this system.”

“The inhabitants refer to the planet as, Earth. Your state of dormancy precedes the systems birth.”

“The situation to be dealt with is on this planet then?”

“It is.”

“All other efforts have not brought about required results?”

“Only to a limited extent.”

“Very well. Present the circumstance as it is.”

THE HISTORY

“A full history is available amongst planetary records, as expected, but a somewhat concise explanation grants that natural development of Sentient life on this world, saw several different branches evolving.

With a native Humanoid and a native Reptilian, being the two prominent.

Primarily, an unconventional resolution is required regarding the Humanoid branch and its manipulation.

It is foreseen that the current Human species is on path for total collapse, if a major intervention is not undertaken. Even though, the basis of this situation, results from many previous unwise interventions.”

Ardath turns back to face the planet below and exhales sombrely, as he continues to relay his report amidst the darkened silence of his lodging.

“Those native Humanoids do not appear familiar to these presently. As they were larger in size, having a covering of thick long body hair, excluding the face.

Off-world races having come to this planet, found them to be quite suitable for utilisation as a labour force in various on-world tasks. Given that surface conditions would not permit themselves to remain for prolonged periods of time.

However, the natives were not as accommodating as their visitors would have anticipated, so it was decided to develop a species that met the requirements needed, but also being unquestioningly obedient to those they were to serve.

To achieve this, formative substance from the off-world race had been blended with an indigenous species, creating a hybrid branch. The perceptive state of this offshoot was then restricted to material levels, limiting its underlying Sovereignty.

It came to be discovered that by introducing severe traumatic conditions within psychological structure, makes it acutely problematic for the perceptive state to transition through these seemingly overwhelming barriers. Thus, leaving a life form of sufficient intellectual capability, yet avoids a non-compliant difficulty.

Additionally, a concept of “God” was configured into the new species, to ensure forthcoming obedience.”

“What is this, God?”, inquires the ubiquitous presence.

“It is presented as the Creator of the Universe, which must be revered and obediently worship, for risk of being outcast to a place of eternal torment, should One ever oppose or even question its authority.”

“This seems rather absurd to any rational reckoning.”

“Of course. But this is, What IS.”

Walking over to a small table, Ardath pours a tea-like beverage into a glass receptacle and ingests a sip, then supports it in the palm of his other hand, taking a moment to arrange the remaining mass of convoluted historical threads, into a succinct yet comprehensible form.

“For quite a time this was successful. Soon, other off-world groups came and performed modifications to this new species, utilising it for their own purpose.

Considerable changes were made, modifications introduced. Countless races infusing their own material onto the elemental biological framework.

Compounding all this, were numerous destructive natural events, which contributed to trauma already induced within psychological structure. Resulting in the perceptive state being forced ever closer toward the material boundary, restricting awareness and intelligence further.

Malicious entities sensing vulnerabilities, took advantage of the situation. Establishing pervasive systems and structures, as parasitic mechanisms for vitality extraction from the Souls bound to these servile Humans.

It was not long before Souls were essentially depleted into lifeless husks, a direct result of insurmountable feeding operations.

As Sentient populations grew, the deficiency of viable Souls saw replenishment by the Etheric Field birthing new Souls. These young Souls were obviously not developed to

a sufficient level to be able to withstand, let alone overcome, such a tremendous onslaught.

Young Souls have been lost in numbers that are shameful to even mention. The Etheric Field's ability to continually birth new Souls at the required rate, has reached a limit.

Furthermore, the Energetic environment of this Earth is shifting. The planet will no longer be amiable to Sentient individuals of a stunted perceptive disposition.

Unless these individuals advance, they will find the ever-increasing Energetic intensity becoming more and more inhospitable. Such that their level of diminutive perception will provide them ample opportunity to vacate this world.

If conditions are left untended, self-sustaining Sentient life here will become impossible. Karmic consequence for the interference is then carried by all those involved for the lifetime of their Souls. In many cases, Karmic consequence shall outlive the Souls themselves.”

THE SITUATION

A growing tenseness developed as Ardath unravelled the saga. With a stern and less restrained reply impacting him significantly, although somewhat less than he was anticipating.

“What of it?

Planets, indeed, entire systems have been lost before.

Why should this circumstance require the awakening of this Soul and the utilisation of its final manifestations?

Why is it that the great Ardath or other Kah Duhran cannot deal with this themselves?

Let these Souls, these Beings, face the repercussions of their actions.

Let them humbly accept the opportunity to learn restraint, prior to interfering in areas they are either not invited or lack the wisdom to deal with.

A BEAUTIFUL ACHING

Let this be an example lesson for all involved and all observing.

Let this catastrophe be their burden to bear.”

An empty pause allows space for tensions to ease, before Ardath ventures to continue.

“Agreed.

Although, an occurrence has come about which changes response options considerably.

The material additions and manipulations have yielded an unexpected potential. One that was not noticeably present in any of the parts.

Granted, as currently embodied, the Earth Human is seemingly of little evident value, beside a source of biological material.

But upon a full awakening, is able to readily penetrate deeper into the Void than any other know species.

Beyond the level of the Soul itself.”

The interaction ends abruptly...

...

...

...

After a time, a response emanates from the emptiness.

“Investigation has revealed the level of energetic intensity which can be endured by this hybrid species is significant.

To such an extent, that at its maximal levels it is able to reach conditions which cause deep awareness pathways to develop, extending significantly beyond the Soul itself.

As you are aware, there is possibility for this in other races, since these are the vehicles of Kah Duhran. But it is not prevalent.

Amongst Earth Humans, it is almost common.

What was not foreseen by those forming this combined species, was the degree to which these suppressing mechanisms would be rejected.

Natural tendencies for the perceptive state to return to the Source were severely underestimated. The biological resilience developed through hybridisation, gave the material form an inherent potential stability to withstand the extreme turmoil that natural counteracting processes generate. It could even be considered a hyper-elastic reaction.

By pressing the perceptive state toward an extreme separation from the Soul, stimulates remedial measures to compensate. Which then propels the perceptive state beyond the Soul itself, whilst the vessel remains intact.

However, the activation of this response is unpredictable. As those unaware of it occurring find it difficult to trust and adapt to. Fighting with it continually, mostly to their own detriment.”

“It seems grounds for intervention are warranted.” Ardath proclaims.

“Agreed, an unconventional intervention has merit in this case.

Have efforts to stabilise the situation begun?”

“Volunteer Souls from this galaxy and others are being inserted into the Etheric Field as a stabilisation measure.

These Souls are then better able to contend with the volatile instability of the Human psycho-biological organism, arresting the effects of malicious parasitic forces.

Soul insertion programs have been carried out to coincide with the dramatic increases in population growth on the planet.

A BEAUTIFUL ACHING

This very craft is one of many platforms from which such programs operate. In fact, there is another insertion event occurring soon, that may be taken as an opportunity to join.”

“If all facilitating arrangements can be made beforehand, then yes, this would be advantageous.”

“It must also be noted, many of the Souls responsible for this dilemma have volunteered to assist in these stabilisation efforts, both on and off world.

Should a course of action be initiated to reverse the degradation, their co-operation would no doubt be available”

“This is appropriate and they will be called upon in such a case.

What of the native Reptilian species? Information of their well-being is not immediately available.” Probes the formless entity.

“They predominately dwell underground, having no real contact with the surface races. Their numbers are much fewer than those of the Humans.

Dealings are maintained with certain off-world groups and they monitor the situation above them.”

THE PLAN

Placing the receptacle back on the table, Ardath enquires,

“Regarding courses of action, is there a preliminary perspective on how the decline is to be corrected?”

“Given the nature and trajectory of this situation, an eventual global crisis that provides the awakening opportunity for many, is likely.

The resultant emotional and psychological turmoil grants better receptive conditions for offering alternate truthful perspectives for consideration.

But to maximise this potential, considerable prior arrangements and contingencies must be set in place.

Numerous volunteer Souls will be drawn to participate in this. A base level of Self-Awareness and trusting inner guidance, can direct them toward the actions that are to be instigated.”

Ardath paces the floor in front of the portal and adds,

“It appears there are three primary stages that are to transpire.

One. Establishing Individual Sovereignty as the basis of Human identity and interaction.

Two. Building new decentralised systems and structures based on Individual Sovereignty, which exist in parallel with current systems.

Three. Deconstructing the old centralised parasitic structures.”

“That is a sound summation.

At best, the process may simply require clarity and direction at appropriate periods to keep it progressing. The details of course, shall no doubt become more apparent as circumstances develop in the moment.

This approach offers the least destructive path, although great difficulty will still need to be overcome, from which substantial benefits might yet emerge.”

THE ROLE

Discourse ceases briefly, as time is allowed for the full exchange to settle and possibly any other considerations to arise.

“Is there perhaps a foreseeance of the material expressions and manner they are to be manifest?”

Ardath queries, gauging the mode of the undertaking.

A BEAUTIFUL ACHING

“It is a manifestation of three. One male and two females.”

“Is this spanning several temporal periods?”

“No, just one. A Soul Trinity.”

“Three material expressions within the same temporal period?”

“That is correct. The male is the anchor, whose temporal span encompasses the two females.”

“Balance and stability may be a cause for concern, dealing with so much at once.”

“If this is how it is best executed, then this is how it shall be done.”

Again, a pause, as an earnest sensation permeates the room, before Ardath receives confirmation of that which saddens him.

“Do all entangled parties calling for this Souls involvement understand the consequences of proceeding?”

“They do.”

“Upon conclusion of the final life, this Soul’s time is ending. It will no longer be available, success or failure.”

“This is Understood.”

“Very well, let us then proceed.”

THE PREPARATION

Ardath stood with his back toward the viewing portal, hands crossed at front.

A singular point in space immediately opens up with a brilliant flash of light, leaving this large unsettling creature before him.

Recognising what was manifest, a reminiscent grin finds its way onto Ardath's face.

Humanoid in form and definitely male, a hairless body covered by plates of hard calloused skin, as the creature's thick broad shoulders reach just above the Emissary's head.

Startling upon first sight, is an odd mannerism of emitting short bursts of air out of its nostrils, whilst scrunching its face in the process.

"I remember this incarnation." Ardath muses.

"Taarak is the name, is it not?"

"As I recall, it was buffoonish and rather obnoxious in nature."

The creature spoke in a deep, gruff voice,

"Yes, those aspects were amusing."

"It may be entertaining to play with them one last time, if opportunity permits."

Blasting his nostrils, whilst scrunching his face at the end of the sentence.

"The planetary rules of entry and interaction dictate that abilities such as simply appear and disappear will not be available once incarnate."

"This shall not be necessary and it is of no real importance."

"Let us go find a gown to cover you with, it will give you opportunity to amuse yourself, playing the obnoxious buffoon, naked."

"Something to fit a large Suhn Gar should be the appropriate size."

The door opens before them and Taarak duck's underneath, then closes again, as they both venture down the corridor.

A BEAUTIFUL ACHING



A BEAUTIFUL ACHING

FOURTH K'DUHN

Opportunity for Redemption
is a door that should never be locked.

However, Injustice is a door
that should never be left open.

.

Opportunity for Redemption
is a door that opens inward.

So if obstructed from the inside,
it can never be opened.



A BEAUTIFUL ACHING

T THE INSERTION

After boarding and completing the screening process, Ohre'Na walks down a corridor toward the entrance that knowingly, she was not coming out of. The transition through screening left her nothing more than a thin white gown as a covering, along with a blue pill in a small chest pocket, which is to be taken once instructed.

Her athletic bipedal Feline features and graceful movement typify the physical characteristics of a young adult Torgehn female.

Being keenly cognisant of the surprise induced in those passing by, she responds in kind to the respectful bowed heads, since Torgah are highly regarded for their astute insight and wisdom, even at a relatively young age and it was not common for a Torgehn to be seen in bodily form outside their home world of Urehn Dek.

How she came to be here is difficult to rationalise, only that a gossamer thread pierced her heart and drew her from a distant segment of the galaxy, concluding on the other side of the approaching doorway.

Aware of the plight on the planet currently orbited, she understood that her Soul would soon become an intrinsic part of its unfolding destiny.

Passing through a scanning field as she reaches the entry, it confirms Ohre'Na's identity before opening and allowing admission, then closing behind, once she enters the moderately crowded holding chamber.

"No turning back.", is the sensation that subtly bursts from within, having now come to the end of her mystical navigation aid.

The entire facility is lined with a semi-reflective, mostly homogeneous metallic material. There are no furnishings of any kind, apart from a boxed section along the entire perimeter, incorporated into the walls and floor. Small openings in the vertical face indicate a venting network of sorts and given the suitable proportions, the ductwork functions as seating for some of those present.

A BEAUTIFUL ACHING

Observing the attendees, it seems as though a multi-racial gathering is underway, owing to sentient life-forms from across the galaxy and beyond represented. Most recognisable, a few not.

Then, as her eyes continue scanning, they fall upon a familiar form, one that was not expected in this place. A form, that like her own, is rarely found outside the fourth planet of the Urehn system.

The Torgehn male is seated on the peripheral formwork, across to the left side of the entry. Patiently waiting, yet watching those arriving, with only a barely perceptible change of expression as Ohre'Na establishes a visual connection.

Memories of her late grandfather wash over her like a wave, whilst making way toward a familiar presence. His large gleaming sapphire-blue eyes, similar to her own, help in promoting feels of ease amongst the tense apprehensiveness of the room.

"Greetings Shah.", she offers. Shah, being a respectful term for elder males of their race.

"Well met young one.", the old Torgehn replies. With a depth of calm intent in his voice, that gestures to the many long years of wisdom gained. Even for a Torgehn, his age is noteworthy, but far from frail is the physique and demeanour exhibited. As the muscular frame of a Feline male in his prime is still enduring.

"It seems you and I find ourselves far from home, young siekha.", he continues.

Expressing an endearing smile, impressions of Ohre'Na's grandfather become more vivid, as, *"young siekha"*, is how he often referred to her.

"It is an age since I was last called siekha, Shah."

"Given my protracted life, you are still young enough for me to call you siekha."

"I am Ghen and like you, find myself in this place, at this time."

"Ohre'Na is my name. Protracted life or not, I am pleased to find you here."

"Come, sit by me young siekha. This waiting would be better filled with some pleasant company."

“Thank you, Shah Ghen.”

Ohre’Na sits, leaning against the wall behind her. Feeling somewhat relieved that the journey to this point was over.

“Have you been aboard long?”, Ghen inquires.

“I have not yet seen a full day of this world’s cycle and you?”

“Ah, several I have witnessed and they have proven quite intriguing.”

Indeed, just the day past, a strange occurrence arose about the ship.”

“In what manner?”

“A few days prior, a Kah Duhran by the name of Ardath was invited to board, along with many other prominent members of various races. However, I am unable to discern the nature and purpose of their visit.”

Then, the day gone past, a rather unusual presence surrounded this vessel. It was as though the history of a billion lifetimes opened wide a hole in space and enveloped the entire craft within itself.

Truly peculiar experience.”

“Perhaps this is reason for the Kah Duhran’s attendance?”

“Yes, I sense a correlation.”

Meanwhile, the entry doorway at the far side of the enclosure opens once again, giving way to a curious and very large creature. It appears somewhat Human, apart from a covering of sizeable calloused growths that have an approximate resemblance to plate armour. At least, this is inferred from the arms and legs, which are not concealed by the uniformly prescribed gown.

“I am not familiar with this race.”, comments Ohre’Na, upon observing its appearance.

“Nor I.”, the old Torgehn responds.

A BEAUTIFUL ACHING

They both watch, as it strolls up to a group of Rengeth, then pokes one in the arm saying,

“Taarak stand here now.”, in a heavy gruff voice.

As the Rengethi stumbles sideways from the force of the push, this, *“Taarak”*, steps forward onto the spot vacated and simply stands there. Blasting his nostrils, whilst scrunching his face.

The shorter and slender Rengethi, clearly displeased by the rude incursion, chooses to not escalate and moves off with the rest of his group, over to the other side of the premises.

Ohre’Na, noting the ample free space to stand elsewhere, expected a serious altercation as she watches astonished that the Rengeth uncharacteristically walk away without reprisal and Taarak, unmoved from his newly gained territory, blasts his nostrils, whilst scrunching his face.

A gentle smile, accompanying a lightened mood is the reaction to Taarak’s goofy manner. But after pondering a short while, concerns begin to arise.

“Shah Ghen, why would such a creature have come to be here? Has it lost its way? This seems not the situation for it.”

“Hmm, at times a facade may misrepresent the underlying substance, in favour for, or against. I suspect there is more being obscured.”

One moment! Are you able to detect that siekha? The craft is moving toward closer proximity to the planet.”

“Yes.”

“It must soon be time.”

A disquiet percolates within the two Torgehn and once noticing this about themselves, glance around the room to gauge similar sentiment among the rest of their companions.

Ohre'Na spots Taarak leaving his occupied territory, headed in the direction a female D'Jogar, standing in an apparent meditative state, not too far from herself. D'Jogar, are easily identifiable due to the elongate cranial structure. This results in acute analytical abilities, as a consequence of their skulls capacity to house a larger brain.

As the oversized creature comes to a stop behind the D'Jogarri, he inspects her hairless ovoidal head, which reaches the level of his chin, then begins rubbing the top of it in a back and forth screwing motion with the tips of his plump fingers.

Stunned, the D'Jogar whips around to confront the disruption, only to be stunned once more from being looked down upon by a monstrous beast.

After composing herself, the two are left to stare at one other for several moments, when suddenly, Taarak blasts his nostrils, whilst scrunching his face.

Initially perplexed, the D'Jogarren female soon offers a reluctant grin, tapping the impertinent brute on the chest, then continues on with her meditation.

Chuckles emanate from a number of points around the room, as Ohre'Na observes the crowd watching the unfolding antics. Others simply appear more at ease by the unexpected capricious actions from this enormous oddity.

Looking back to Taarak, she finds an intense gaze directed at her. His eyes piercing hers, feeling as if peering into a deep chasm, being drawn inside a well that opens out to a vast overflowing void of emptiness. Perceptions of her present environment fading, the surrounding chatter, falling silent.

She pulls away abruptly, when the sense of getting lost in the irresistible nothingness almost consumes her very essence.

"Is everything satisfactory, siekha?", enquires Ghen.

"I'm unsure... Yes, I'm fine.", shaking her head.

The movement of the ship ceases, then an overwhelming sensation alerts to the occasion that has drawn them all here. Prompting attention toward the small blue pill, which each occupant has within the chest pocket of their minimal attire.

“Well my dear Ohre’Na, our time was short, but I bid your Soul a rewarding journey.”

“As I do yours, Shah Ghen.”

Ohre’Na probes the gown pocket, removing the capsule of her finality. Holding it in hand, gazing at it, as thoughts of her life, her family, her friends all come flooding back. The physical heaviness of heart is a feeling that is unfamiliar, even though the earnest sadness and longing are not.

“Do I want to do this...?”

Can I leave...?

Should I go back the way I came...?”

A commotion in front distracts from her thoughts, she sees Taarak struggling to recover the blue pill from the pocket of his garment, thick fingers proving cumbersome.

The D’Jogarri turns and also witnesses the difficulty, so reaches in to retrieve it herself and places it in the agitated creature’s hand. Taarak blasts his nostrils, whilst scrunching his face. Then bringing hand to his mouth, sucks down the pelletised potion.

Gratitude illuminates his stout face, as a response to the helpfulness delivered by a gracious stranger, which only moments earlier he rudely disrupted with his mischievous behaviour. Following an acknowledging smile, Taarak seats himself on the floor and after a few deep breaths, lifelessly slumps forward.

While ingesting her pill, the D’Jogarren decides to spend the last repose with a new friend and sits behind the body of this obnoxious annoyance, her back against his. Soon after, head dropping to her chest, signifying the final outcome of mortality.

Turning to look left, Ohre’Na sees Ghen, motionless, propped up by the wall, head to one side.

Surveying the rest of the premises, a silent stillness remains. Her own breathing and heartbeat, being all she can detect.

Leaning back, placing the cap in her mouth, she swallows and closes her eyes. With little time to ponder, the mass of her body becomes significantly more pronounced, when suddenly, a release. Which then gives way to an unbound weightlessness.

The perception of what Ohre'Na was, drifts off down a tunnel, fading into memory. Leaving a formless Awareness witnessing the inanimate shell with detachment. An irresistible vacuum from the desperate planet below, draws the Awareness deeply within its Etheric Field, like nourishment to a starving life-form, in an attempt to revive much depleted vigour.

So with no further life signs detected, a powerful energetic pulse is emitted into the enclosure, atomising all biological material. The venting system quickly evacuates the internal atmosphere out into space, before replenishing it again.

The facility is now clean and ready to be utilised, once more.



A BEAUTIFUL ACHING

FIFTH K'DUHN

The Understanding of One's Self,
is best viewed in a Mirror.

The Growing of One's Self,
is best achieved looking Forward.

The Experiencing of One's Self,
is best savoured in the Now.

.

The Mastery of One's Self,
Converges the Three.



A BEAUTIFUL ACHING

T SIXTH K'DUHN

When Fear is no more,
only the One then remains.



A BEAUTIFUL ACHING

FOUNDATIONS OF THE FORMLESS

The Teachings of The Kah Duhran.

...

FIRST K'DUHN

Kah Duhran never refer
to themself as, Kah Duhran.

They do not deny it.
They do not confirm it.
They do not reference it.

But when it needs to be known,
their Presence will announce them.

...

SECOND K'DUHN

What defines Kah Duhran,
is not how many enemies One can slay.

Instead, it is the calm and resilience One embodies,
when facing a merciless and tumultuous onslaught.

...

THIRD K'DUHN

A Pure Heart
is Poison for the Wicked.

...

FOURTH K'DUHN

Opportunity for Redemption
is a door that should never be locked.

However, Injustice is a door
that should never be left open.

.

Opportunity for Redemption
is a door that opens inward.

So if obstructed from the inside,
it can never be opened.

...

FIFTH K'DUHN

The Understanding of One's Self,
is best viewed in a Mirror.

The Growing of One's Self,
is best achieved looking Forward.

The Experiencing of One's Self,
is best savoured in the Now.

.

The Mastery of One's Self,
Converges the Three.

...

SIXTH K'DUHN

When Fear is no more,
only the One then remains.



A BEAUTIFUL ACHING

APPENDIX C - HOLLOWING THE SPHERE CALCULATIONS

This is a supplemental document to the verse, [The Illusion Of Growth](#).

INTRODUCTION

The process of Hollowing the Sphere is based on the premise of starting off with a solid sphere, hollowing it out and the material that is removed from the core is then evenly applied to the surface of the original sphere, thus increasing its outer diameter.

This is subsequently repeated by removing more material from within the now hollow sphere and again applying it to the surface of the newly enlarged sphere.

Exploring and developing a logical and systemic mathematical model of the process is the purpose of this document. It is intended to ascertain any underlying patterns which may be present and to support the material that is expressed in the original verse, [The Illusion Of Growth](#).

The full step by step methodology will be presented deeper within this document, but first some foundations will be established.

THE BASICS

SOLID SPHERE

The equation to determine the volume of a solid sphere is,

$$V_{solid} = \frac{4\pi}{3} r_{solid}^3$$

Where, V_{solid} = Solid sphere volume.

r_{solid} = Solid sphere radius.

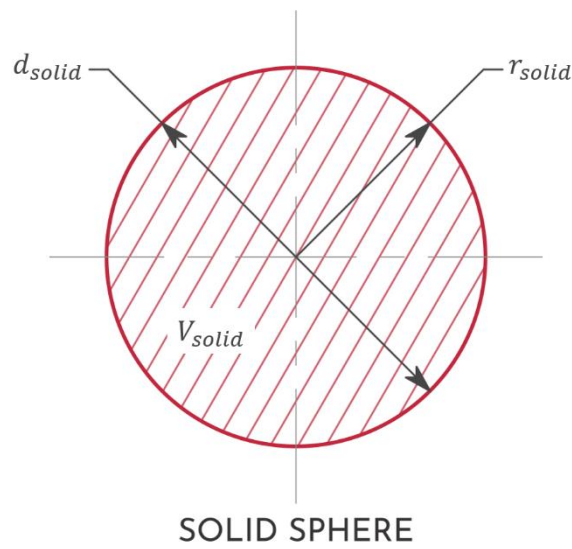

HOLLOW SPHERE

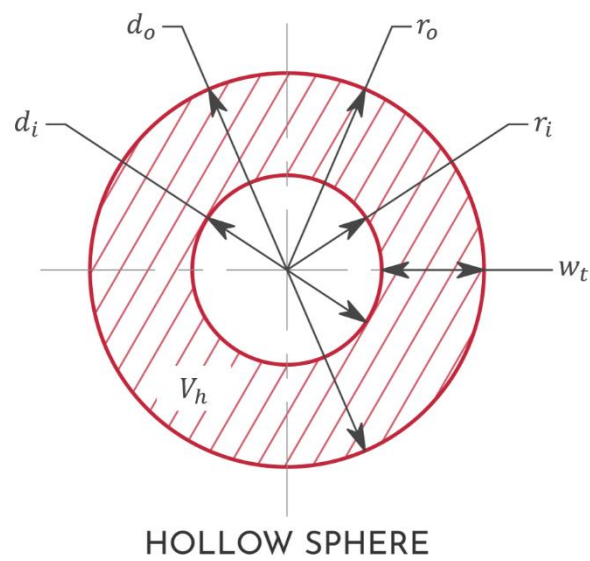

Determining the material volume of a hollow sphere requires that the hollow volume be subtracted from the solid volume.

The solid volume of the sphere is found by evaluating,

$$V_o = \frac{4\pi}{3} r_o^3$$

Where, V_o = Solid volume of a hollow sphere.

r_o = Outer radius of a hollow sphere.

The hollow volume of the sphere is then found by evaluating,

$$V_i = \frac{4\pi}{3} r_i^3$$

Where, V_i = Hollow volume of a hollow sphere.

r_i = Inner radius of a hollow sphere.

The material volume of the hollow sphere is then determined by subtracting the hollow volume from the solid volume.

$$V_h = V_o - V_i$$

Where, V_h = Material volume of a hollow sphere.

This process can be combined into a single equation as shown below.

$$V_h = \frac{4\pi}{3} r_o^3 - \frac{4\pi}{3} r_i^3$$

Simplifying this equation produces the following form,

$$V_h = \frac{4\pi}{3} (r_o^3 - r_i^3)$$

CONSTANT VOLUME

For this process the material volume of all the spheres remains constant. No new material is added and no material is taken away.

Therefore, the volume of the solid sphere is the same as the volume of the hollow sphere at all subsequent iterations.

Expressed in equation form gives,

$$V_{solid} = V_h$$

Replacing the volume terms with the radius base terms gives,

$$\frac{4\pi}{3} r_{solid}^3 = \frac{4\pi}{3} (r_o^3 - r_i^3)$$

Dividing both sides by $\frac{4\pi}{3}$ leads to the Constant Volume Radius equation,

$$r_{solid}^3 = r_o^3 - r_i^3$$

DETERMINING DIAMETER FROM WALL THICKNESS

A short cut method for determining the hollow sphere outer diameter based on a specified wall thickness will be shown in this section. This simplified approach was utilised to produce [Table 1](#) of condensed steps in the blog verse, [The Illusion Of Growth](#).

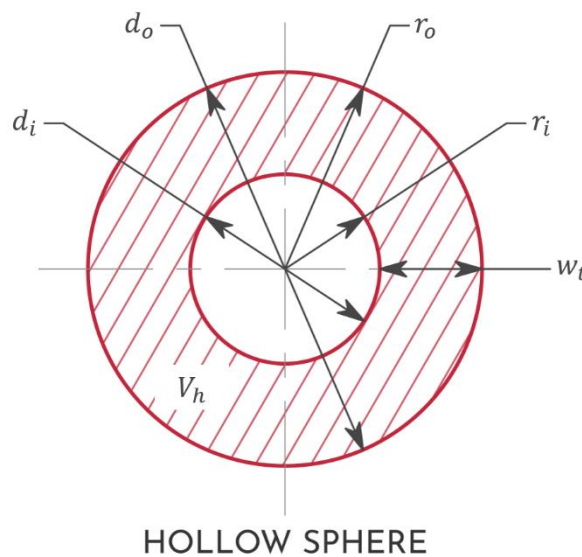

The wall thickness of a hollow sphere is the difference between the outer radius and the inner radius.

$$w_t = r_o - r_i$$

Where, w_t = Wall thickness of a hollow sphere.

Rearranging this in terms of the inner radius gives,

$$r_i = r_o - w_t$$

Substituting this expression of the inner radius into the Constant Volume Radius equation,

$$r_{solid}^3 = r_o^3 - r_i^3$$

results in,

$$r_{solid}^3 = r_o^3 - (r_o - w_t)^3$$

Expanding this out leads to,

$$r_{solid}^3 = r_o^3 - (r_o^3 - 3w_t r_o^2 + 3w_t^2 r_o - w_t^3)$$

$$r_{solid}^3 = r_o^3 - r_o^3 + 3w_t r_o^2 - 3w_t^2 r_o + w_t^3$$

$$r_{solid}^3 = 3w_t r_o^2 - 3w_t^2 r_o + w_t^3$$

Subtracting r_{solid}^3 from both sides becomes,

$$3w_t r_o^2 - 3w_t^2 r_o + w_t^3 - r_{solid}^3 = 0$$

This is now in the form of a quadratic equation and so the Quadratic Formula can be used to calculate a result.

For a quadratic function in the form,

$$f(x) = a x^2 + b x + c$$

Provided that $(b^2 - 4ac) \geq 0$, the Quadratic Formula for the zeros of this equation is,

$$x = \frac{-b \pm \sqrt{b^2 - 4ac}}{2a}$$

So, from the radius and wall thickness equation,

$$3w_t r_o^2 - 3w_t^2 r_o + w_t^3 - r_{solid}^3 = 0$$

The parameters for the Quadratic Formula are,

$$a = 3w_t$$

$$b = -3w_t^2$$

$$c = w_t^3 - r_{solid}^3$$

From this, the Quadratic Formula with reference to the outer radius of a hollow sphere, r_o , takes the form of,

$$r_o = \frac{3w_t^2 \pm \sqrt{(-3w_t^2)^2 - 4(3w_t)(w_t^3 - r_{solid}^3)}}{2(3w_t)}$$

This then reduces down to two possible solution for the outer radius of the hollow sphere, r_o , in terms of the initial radius of the solid sphere, r_{solid} and the current wall thickness of the hollow sphere, w_t .

$$r_o = \frac{3w_t^2 + \sqrt{12w_t r_{solid}^3 - 3w_t^4}}{6w_t}$$

and

$$r_o = \frac{3w_t^2 - \sqrt{12w_t r_{solid}^3 - 3w_t^4}}{6w_t}$$

By placing values into the second equation it is found to give negative solutions for the outer radius, r_o . These negative values are physically not possible so the viable solutions come from the first equation,

$$r_o = \frac{3w_t^2 + \sqrt{12w_t r_{solid}^3 - 3w_t^4}}{6w_t}$$

To test this out, the following values will be assigned to the equation variables,

$$w_t = 10 \text{ mm}$$

$$d_{solid} = 100 \text{ mm}$$

$$r_{solid} = \frac{d_{solid}}{2} = 50 \text{ mm}$$

The outer radius of a hollow sphere with a 10 millimetre wall thickness and an equivalent solid material diameter of 100 millimetres or radius of 50 millimetres is,

$$r_o = \frac{3w_t^2 + \sqrt{12w_t r_{solid}^3 - 3w_t^4}}{6w_t} = 69.49 \text{ mm}$$

From this the outer diameter of the hollow sphere is,

$$d_o = 2 r_o = 138.97 \text{ mm}$$

This answer corresponds with the value presented in [Table 1](#) of the verse, [The Illusion Of Growth](#), for the hollow sphere with a 10 millimetre wall thickness.

It is also useful to perform a check to ensure that the volume of this hollow sphere is the same as that of the solid sphere.

The volume of the solid sphere is,

$$V_{solid} = \frac{4\pi}{3} r_{solid}^3 = 523,598.78 \text{ mm}^3$$

Next find the inner radius of the hollow sphere for the given wall thickness.

$$r_i = r_o - w_t = 59.49 \text{ mm}$$

A BEAUTIFUL ACHING

Following on, the inner diameter of the hollow sphere, d_i , is,

$$d_i = 2 r_i = 118.97 \text{ mm}$$

Finally, the volume of the hollow sphere is,

$$V_h = \frac{4\pi}{3} (r_o^3 - r_i^3) = 523,598.78 \text{ mm}^3$$

To summaries these results,

For the solid sphere, the parameter values are,

The diameter of the solid sphere, $d_{solid} = 100 \text{ mm}$.

The volume of the solid sphere, $V_{solid} = 523\ 598.78 \text{ mm}^3$.

For the hollow sphere, the parameter values are,

The new outer diameter of the hollow sphere is, $d_o = 138.97 \text{ mm}$.

The new inner diameter of the hollow sphere is, $d_i = 118.97 \text{ mm}$.

The wall thickness of the hollow sphere is, $w_t = 10 \text{ mm}$.

The material volume of the hollow sphere is, $V_h = 523\ 598.78 \text{ mm}^3$

The volume of this hollow sphere is the same as that of the solid sphere which shows that the hollow sphere fits within the progression of the defined hollowing process.

So, if the intent is to find the outer diameter of a hollow sphere which has a particular wall thickness, based on a certain sized solid sphere, then this is the approach to be taken.

THE METHODOICAL APPROACH

This methodical approach can be used to achieve the same outcome as in the previous section but it requires far more steps to reach the target wall thickness. Its benefit is simply to show that a physicalised process is possible, although it is very cumbersome.

This methodical approach was utilised to produce [Table 2](#) in the blog verse, [The Illusion Of Growth](#).

A summary of the methodology is presented below.

Iteration 1.

- Step 1 – Start with a Solid Sphere Diameter.
- Step 2 – Determine the Solid Sphere Volume.
- Step 3 – Select the Core Diameter.
- Step 4 – Calculate the Core Material Volume.
- Step 5 – Calculate the Increase in Diameter.
- Step 6 – Calculate the Wall Thickness.
- Step 7 – Check the Volume.

Iteration 2.

- Step 1 – Determine the Diameter for Material Removal.
- Step 2 – Calculate the Material Volume for Removal.
- Step 3 – Calculate the Increase in Diameter.
- Step 4 – Calculate the Wall Thickness.
- Step 5 – Check the Volume.

Iteration 3 and on.

Repeat Iteration 2 until the desired number of iterations is reached.

The above summary will next be explained more fully.

ITERATION 1

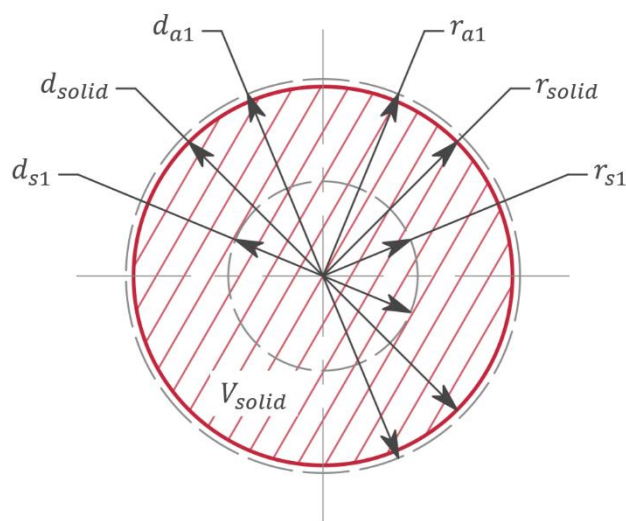

HOLLOWING - ITERATION 1

A BEAUTIFUL ACHING

STEP 1 - START WITH A SOLID SPHERE DIAMETER

Start off with a solid sphere, in this case 100 millimetres in diameter.

$$d_{solid} = 100 \text{ mm}$$

Where, d_{solid} = Solid sphere diameter.

STEP 2 - DETERMINE THE SOLID SPHERE VOLUME

Calculate the volume of the solid sphere using the equation,

$$V_{solid} = \frac{4\pi}{3} r_{solid}^3$$

Where, V_{solid} = Solid sphere volume.

r_{solid} = Solid sphere radius.

$$r_{solid} = \frac{d_{solid}}{2} = 50 \text{ mm}$$

$$V_{solid} = \frac{4\pi}{3} r_{solid}^3 = 523,598.78 \text{ mm}^3$$

STEP 3 - SELECT THE CORE DIAMETER

Generally, to determine the amount of core material to remove, the mean diameter of the wall thickness is chosen. In this initial case however, this is not possible as the sphere is still solid, so an equivalent value of half the sphere diameter is selected instead.

$$d_{s1} = \frac{d_{solid}}{2} = 50 \text{ mm}$$

STEP 4 - CALCULATE THE CORE VOLUME

The volume of material to remove from the core at the chosen diameter is found by evaluating,

$$V_{s1} = \frac{4\pi}{3} r_{s1}^3$$

Where, V_{s1} = Inner material volume to be removed.

r_{s1} = Inner radius of material to be removed.

$$r_{s1} = \frac{d_{s1}}{2} = 25 \text{ mm}$$

$$V_{s1} = \frac{4\pi}{3} r_{s1}^3 = 65,449.85 \text{ mm}^3$$

STEP 5 - CALCULATE THE INCREASE IN DIAMETER

From this core material volume, calculate the increase in the sphere diameter when that material is placed evenly on the surface of original sphere.

Essentially, there is a shell added to the surface of the sphere which also happens to be a hollow sphere. The thickness of this shell is the increase in the radial thickness of the hollow sphere.

This gives rise to the following variables to be determined,

$$V_{a1} = V_{s1}$$

$$r_{a1} = \text{To be determined.}$$

Where, V_{a1} = Material volume to be added to the surface of the sphere.

Which is equal to the volume removed from the core.

r_{a1} = Outer radius of the sphere with the new added material.

The equation for the addition of this shell material is,

$$V_{a1} = \frac{4\pi}{3} (r_{a1}^3 - r_{solid}^3)$$

Rearranging this to find the outer shell radius gives,

$$\frac{3V_{a1}}{4\pi} = r_{a1}^3 - r_{solid}^3$$

$$r_{a1}^3 = \frac{3V_{a1}}{4\pi} + r_{solid}^3$$

$$r_{a1} = \sqrt[3]{\frac{3V_{a1}}{4\pi} + r_{solid}^3}$$

Evaluating this equation with the know variables comes to,

$$V_{a1} = V_{s1} = 65,449.85 \text{ mm}^3$$

$$r_{a1} = \sqrt[3]{\frac{3V_{a1}}{4\pi} + r_{solid}^3} = 52.0021 \text{ mm}$$

Then the diameter of the now enlarged sphere is,

$$d_{a1} = 2 r_{a1} = 104.004 \text{ mm}$$

Where, d_{a1} = Outer diameter of the enlarged sphere.

STEP 6 - CALCULATE THE WALL THICKNESS

Calculate the wall thickness of this now hollow sphere.

$$w_{t1} = \frac{(d_{a1} - d_{s1})}{2} = 27.0021 \text{ mm}$$

Where, w_{t1} = Wall thickness of the hollow sphere after Iteration 1.

STEP 7 - CHECK THE VOLUME

As a check, the material volume can be calculated for this hollow sphere to ensure that it is the same as the original solid sphere.

$$V_{h1} = \frac{4\pi}{3}(r_{a1}^3 - r_{s1}^3) = 523,598.78 \text{ mm}^3$$

Where, V_{h1} = Material volume of the hollow sphere after Iteration 1.

As is evident from the result of this equation, $V_{h1} = V_{solid}$.

ITERATION 1 SUMMARY

This now leaves a hollow sphere with a wall thickness and an outer diameter that is greater than the original.

For the original solid sphere, the parameter values are,

The diameter of the solid sphere, $d_{solid} = 100$ mm.

The volume of the solid sphere, $V_{solid} = 523,598.78$ mm³.

For the new hollow sphere, the parameter values are,

The new outer diameter of the hollow sphere is, $d_{a1} = 104.00$ mm.

The new inner diameter of the hollow sphere is, $d_{s1} = 50$ mm.

The wall thickness of the hollow sphere is, $w_{t1} = 27.00$ mm.

The material volume of the hollow sphere is, $V_{h1} = 523\ 598.78$ mm³

ITERATION 2

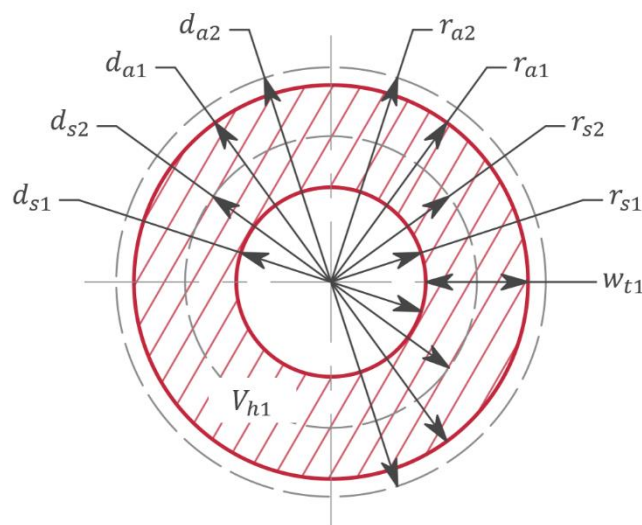

HOLLOWING - ITERATION 2

STEP 1 - DETERMINE THE DIAMETER FOR MATERIAL REMOVAL

For the next part of the inner material to be removed, determine the mean diameter of the wall thickness by evaluating,

$$d_{s2} = d_{s1} + \frac{d_{a1} - d_{s1}}{2}$$

A BEAUTIFUL ACHING

Where, d_{s2} = Mean diameter of the wall thickness at Iteration 2.

d_{a1} = Outer hollow sphere diameter from Iteration 1.

d_{s1} = Inner hollow sphere diameter from Iteration 1.

$$d_{s2} = d_{s1} + \frac{d_{a1} - d_{s1}}{2} = 77.0021 \text{ mm}$$

STEP 2 - CALCULATE THE MATERIAL VOLUME FOR REMOVAL

Calculate the material volume of this inner portion of the sphere at the mean wall thickness diameter.

The mean wall thickness radius is required for this, so,

$$r_{s2} = \frac{d_{s2}}{2} = 38.5010 \text{ mm}$$

Where, r_{s2} = Mean radius of the wall thickness at Iteration 2.

The volume of material to be removed is,

$$V_{s2} = \frac{4\pi}{3} (r_{s2}^3 - r_{s1}^3) = 173,609.79 \text{ mm}^3$$

STEP 3 - CALCULATE THE INCREASE IN DIAMETER

From this established volume, calculate the diameter of the sphere when this material is added to the surface of the enlarged sphere.

$$r_{a2} = \sqrt[3]{\frac{3V_{s2}}{4\pi} + r_{a1}^3} = 56.678 \text{ mm}$$

$$d_{a2} = 2 r_{a2} = 113.356 \text{ mm}$$

STEP 4 - CALCULATE THE WALL THICKNESS

Calculate the wall thickness of this new hollow sphere.

$$w_{t2} = \frac{(d_{a2} - d_{s2})}{2} = 18.1769 \text{ mm}$$

Where, w_{t2} = Wall thickness of the new hollow sphere after Iteration 2.

STEP 5 - CHECK THE VOLUME

As a check, the material volume can be calculated for this hollow sphere to see if it the same as the original solid sphere.

$$V_{h2} = \frac{4\pi}{3}(r_{a2}^3 - r_{s2}^3) = 523,598.78 \text{ mm}^3$$

Where, V_{h2} = Material volume of the hollow sphere after Iteration 2.

As is evident from the result of this equation, $V_{h2} = V_{solid}$.

ITERATION 2 SUMMARY

This again creates a larger sphere with a larger hollow core and thinner wall thickness than previous.

For the previous hollow sphere, the parameter values are,

The outer diameter of the hollow sphere is, $d_{a1} = 104.00$ mm.

The inner diameter of the hollow sphere is, $d_{s1} = 50$ mm.

The wall thickness of the hollow sphere is, $w_{t1} = 27.00$ mm.

The material volume of the hollow sphere is, $V_{h1} = 523\ 598.78$ mm³

For the new hollow sphere, the parameter values are,

The new outer diameter of the hollow sphere is, $d_{a2} = 113.36$ mm.

The new inner diameter of the hollow sphere is, $d_{s2} = 77.00$ mm.

The wall thickness of the hollow sphere is, $w_{t2} = 18.18$ mm.

The material volume of the hollow sphere is, $V_{h2} = 523\ 598.78$ mm³.

ITERATION 3 AND ON

Repeat all the steps in Iteration 2 until the desired number of iterations is reached.

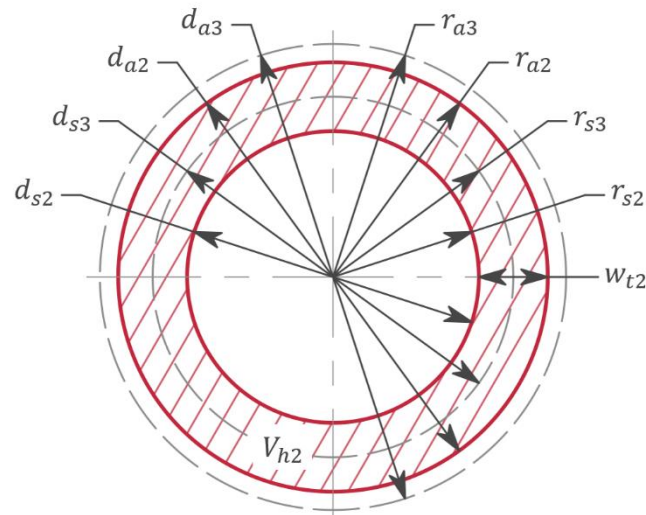

HOLLOWING - ITERATION 3

Repeating these steps continuously will generate larger and larger hollow spheres with thinner and thinner wall thicknesses.

CONCLUSION

The process of Hollowing the Sphere is shown to generate hollow spheres of ever-increasing diameter and thinner wall thicknesses, while maintaining the same volume of material as the solid sphere. Which implies that it retains the same mass as the original, if a material density were to be added to the sphere.

This means that there is an increase in the overall size of the sphere but no increase in the actual substance of the sphere.

So, can the tag of [The Illusion Of Growth](#) be given to an object that grows in size but gains no substantive mass?

It seems fitting.

APPENDIX D - EXYGEN

The following is a copy of a fictional piece written on the Roberts Space Industries website for the computer game, Star Citizen. It describes the History, Manifesto and Charter of an organisation called EXYGEN, which has been created to exist in this fictional universe.

The original post can be found at the EXYGEN, Roberts Space Industries link, <https://robertsspaceindustries.com/orgs/EXYGEN>

EXYGEN

THE LEADER IN EXOGENOUS SUPPLY & SUPPORT SERVICES

To Survive Out There, You Need EXYGEN

HISTORY

Born out of the United Empire of Earth's (U.E.E.) brutal blockade of the Centauri System in 2782, smugglers ran supplies through and around the naval battle group charged with enforcing the embargo. They provided food, medical supplies and arms to the desperate civilian population within the system.

As the military began tightening its grip, to strangle the renegade supply lines, a group of "*independent contractors*" co-ordinated their activities, to keep some form of trade open to the Centauri people. Most were merchants, others were former U.E.E. military providing security escort for the defiant convoys. All knew the importance of continuing, because as history has shown, this was one of the key events which marked the end of the Messer era.

A BEAUTIFUL ACHING

Although a number of original members perished during these confrontations, enough survived to see the blockade end and the regime step back. The empire got a bloody nose and a black eye, but it was not defeated. Consequently, it is from this resilient legacy, that a more conventional enterprise was established.

EXYGEN was founded by the remaining members of this group of blockade runners, to provide security and supply services to areas of the galaxy that others fear to go into. With over 150 years of operation, our crew members have delivered countless supplies, escorted thousands of ships, contended with hordes of pirates and corrupt officials, but also lost many friends and companions along the way. Some have never made it back, yet all were committed to *“Get the Job Done”*.

“Crave No Heaven, Fear No Hell” was a statement first made during the Centauri blockade and something our crew members still echo to this very day. Because to be pilot or crew with EXYGEN, requires this type of attitude and approach. Our people are not spoken about on the News services and they do not get shiny pieces of metal to pin on their chest, nor do they want them. They have seen the conditions that the frontier offers and the struggles that these pioneers endure. So, because of this, they consider their role as making things a little bit easier, a little bit safer and a little less daunting for those that travel the undiscovered path.

MANIFESTO

Exogenous, refers to an action or object coming from outside a system. This essentially describes the activities our founders first engaged in back during the Centauri blockade. We bring in supplies and services from outside your system, to you.

The company name, EXYGEN, is derived from this root word and the tag-line *“To Survive Out There, You Need EXYGEN”* is a play on its similarity to the word, *“Oxygen”*.

Our customers are usually on the fringes of know space and also in some of the more adventurous areas of the galaxy. Some require a little more discretion, while others are pleased to create a whole lot of commotion. We take on jobs of all sizes and importance and can ensure that they are carried out promptly and with a minimum of fuss, or a whole lot of fuss, if such is required.

EXYGEN is comprised of 6 divisions which encompass a broad range of operations, to be able to best serve our customer's needs.

- EXYGEN SECURITY SOLUTIONS provides security services, equipment and personnel for use in areas such as,
 - Property and Personal Protection.
 - Transport and Shipping Escort.
 - Colony and Facility Security.
 - Pirate Infestation Problems.
- EXYGEN TRADING & COMMERCE trades in manufactured goods, resources and technologies. We provide the link between those that are the suppliers in these commodities, to those that required them, throughout dozens of systems in the galaxy. Although human sourced items are the mainstay of our business, we also specialise in non-human items, some of which may be quite difficult to come by.
- EXYGEN SHIPPING & LOGISTICS is your solution if you have something that needs to get from *"Here"* to *"There"*. We will ship almost* any item, from almost* anywhere, to almost* anywhere, spanning the entire galaxy and beyond. With expedited and discreet services available for those special situations that require them.
- EXYGEN EXPLORATION & SALVAGE endeavours to discover unexplored systems and worlds, so as to open up new mining and trade opportunities for those seeking the frontier lifestyle. We also reclaim items of value from derelict ships, deserted colonies and abandoned mining operations to connect them with new owners that may then put them to good use.
- EXYGEN MINING & RESOURCES is a division that is diversified into a number of areas, from mineral extraction to hydrogen collection and refining. The efficiency of our facilities and processes is unrivalled, given that we have

A BEAUTIFUL ACHING

invested in and developed some of the most state-of-the-art technologies in this sector.

- EXYGEN ENGINEERING SOLUTIONS offers engineering services to help repair, maintain and run facilities such as,
 - Ships and Base Stations.
 - Production and Mining Operations.
 - Planet Side Operation and Life Support Equipment.

All of our divisions can and do work in co-operation with one another, to ensure that our customers get the best possible outcome for their investment.

So, if you require a partner to help with these types of services and operations, in some of the less hospitable systems out there, then please do contact us, as we would be delighted to speak with you.

DISCLAIMER

* For legal reasons we have had to add the *“almost”* disclaimer to the above statement, because of past requests to round up the entire U.E.E. regime and its bureaucracy, then deposit them in the farthest black hole in the galaxy. This would be the equivalent of rounding up all the cockroaches on planet Earth and flushing them down a toilet. Although this is theoretically possible, practicality makes this a monumental task. Besides, we may be dumping them on to some unsuspecting version of reality, where they could potentially wreak even more havoc than they do here.

CHARTER

We admire the spirit of those that push boundaries, those that fly uncharted space and those that settle inhospitable worlds. We understand that living life on the edge of known space is perilous and every day is an extreme challenge. This is why we do, what we do.

Our role is to ensure that these pioneers have a chance and that their efforts see some reward. We hope that by supporting their endeavours, they get to experience some of the recognition that they deserve.

So, with this in mind, when we engage new pilots and crew to join our company, we look past the timid and the wannabe heroes. We look for a character that has balls, without the need for an authoritarian uniform. Someone who has the courage to stand alone, against the whole galaxy if need be, but does not shout about it or boast about how tough they are.

These are the type of people that can *“Get the Job Done”*.

These are the type of people that *“Crave No Heaven, Fear No Hell”*.

The statement on our Recruitment page reads,

*If you wanna play the hero,
Go join the military.*

*If you wanna make a difference,
Welcome to EXYGEN.*

But once you're done with the military, come back and join EXYGEN

This is what we're about.

CHARTER - SUPPLEMENTAL POST 1

If you read our History and Charter, you may feel as though we sound more like a charity, rather than a company that offers products and services in trade. Well, if you live life based on the concept of charity, then you see those that you give charity to as second-class individuals.

A BEAUTIFUL ACHING

When you trade with another individual, you approach them as an equal, who has something of value to offer. When you see someone as a charity case, you see them as having nothing of value to offer.

When asked about the issue of charity, one of our original founders was quoted as saying,

*Charity slowly robs a man of his dignity and self-esteem,
Thus once you have stolen it all,
You have taken everything of value he has.*

CHARTER - SUPPLEMENTAL POST 2

Now, if you accept that trade is a respectable and civilised way for individuals to interact, then consider this.

*Government does not trade with you.
Government makes demands of you.*

Government may go to the effort of putting on a caring smiley face while making those demands, or they may dispense with the pretence altogether and just put a gun to your head. But either way, the demands are the same.

In this light, how do you think the U.E.E. and its agents see you?

CHARTER - SUPPLEMENTAL POST 3

Some may still reply,

No, no, no, government is there to protect and serve me.

Government's role **IS NOT** to protect or serve you. Government's role is to create dependency. The more dependent you are on government, the more power government has over you.

*The tool of "Government" is the means through
which the few claim authority over the many.*

CHARTER - SUPPLEMENTAL POST 4

Yes Sir! How High, Sir?

There are those that think the military teaches discipline. The military teaches obedience, not discipline. These two things are not the same.

Self-discipline is a very powerful quality. Obedience is the realm of domesticated dogs.

*Military men are just dumb, stupid animals
to be used as pawns in foreign policy.*

Henry Kissinger

(20th Century politician of the once United States of America)

To the self-anointed "*elites*" who control the U.E.E., military personnel are little more than cannon fodder. Something cheap to throw at an enemy's laser round or blast cannon.

CHARTER - SUPPLEMENTAL POST 5

On the one hand, you have pirates. On the other, you have the U.E.E.

A BEAUTIFUL ACHING

In essence, they are both the same thing.

The only real difference being, is that the U.E.E. has managed to convince you that they have authority over you.

Pirates have not yet been successful in doing so.

CHARTER - SUPPLEMENTAL POST 6

A question that must also be asked is,

*“To what degree do elements within and around
the U.E.E. covertly support pirate activity?”*

Why would they do this?

So as to create the political P.R. opportunity to take control of outlining systems and ensure the continued submission of complaint worlds.

CHARTER - SUPPLEMENTAL POST 7

There will always, always, always be groups and individuals that desire to control, manipulate and have authority over others. It is only a question of whether they do this on a small or a large scale.

When we sign on to the idea of *“Government”* it may well be with the very best intentions, but as the old saying goes,

The road to Hell is paved with good intentions.

By creating an institution which claims authority over everyone and is backed up with the threat of violence, we are creating a honey pot for those that lust political power.

We are giving them the ultimate tool/weapon to dominate, all wrapped up in this veil of legitimacy called, *“For the public good”*.

The real political power in the U.E.E. is not in the position of Imperator, it is in those that created and now control the position.

*The power of the throne is not in the King,
but in the King makers.*

CHARTER - SUPPLEMENTAL POST 8

*Power tends to corrupt and
absolute power corrupts absolutely.*

John Dalberg-Acton (A.K.A., Lord Acton)

This statement is absurd, although the sentiment is understood.

It would be more accurate to rephrase it this way,

*Political power tends to corrupt and
absolute political power corrupts absolutely.*

Political power is about power over others. Political power is an illusion crafted by those that wish to dominate others. Another can only have power over you, if you submit to them.

Real power comes from the individual. It is power over Oneself and One's own life.

One does not come close to touching real, absolute power until One becomes incorruptible.

While you are corruptible you are corrupting the very power that emanates from you.

So, what is corrupting you, you may ask...?

FEAR.

CHARTER - SUPPLEMENTAL POST 9

Those that are weak in real power and are highly ambitious, will seek political power. They will use any means necessary, including deception and violence, to get it, retain it and expand it.

Those that are strong in real power, are Masters of their own destiny. They do not require the obedience of others to live a meaningful and fulfilling life.

CHARTER - SUPPLEMENTAL POST 10

TRUE LEADERS VS POLITICAL RULERS

*Rulers are not the same as Leaders.
Rulers tell you what to do,
Leaders show you.*

True leaders lead by example and recognise the sovereignty of the individual. They are not voted upon, they do not speak for others and they do not require the obedience of others. Instead, others seek them out for guidance and wise council.

True leadership has no hierarchy.

Political rulers are installed by coercion/force or voted for by members of the collective. By extension, they claim to speak for every member of the collective and their authority is based on the threat of retaliation or even violence.

They also issue commandments that other members of the group must follow, such as which enemies to fight, but often exempt themselves from such inconveniences.

Leadership is a quality that an individual has. It **IS NOT** something inherent to an organisational structure. Political systems want to convince you that it **IS** inherent to the organisational structure.

Positions within an organisational structure are positions of responsibility, **NOT** positions of leadership.

Having citizens vote for their political rulers is now the preferred method of operation that the U.E.E. practises, as it gives citizens the delusional impression that they have a say in the functioning of the empire. This is often referred to as “*Democracy*”.

*Democracy is nothing more than mob rule.
Those that control the mob, rule the mob.*

CHARTER - SUPPLEMENTAL POST 11

There are religions that talk about Heaven and Hell and they inform us that both are found in opposite directions to one another. This is a false and deliberate diversion. Hell is what stands between where you are now and Heaven. Heaven is also open to everyone, but **YOU** need to find the courage and a way to get there.

You may also be surprised at what and where Heaven and Hell are. They are not “*Out there*” or “*Up there*” or “*Down there*”. They are not found outside of your own Being, but are states of your own psyche.

Hell is a simple equation, it is the sum total of all your deepest and most intense fears, multiplied by a lot.

Heaven is the peace you will find, when you have explored and understood every facet of this equation.

The cause of insanity, is the denial of legitimate suffering.

Carl Gustav Jung?

Intense suffering will come while engaging your fears, but from this suffering something new is born; courage, resilience, a greater understanding, a deeper sense of Self; until the final realisation.

Organised religions are part of the control mechanism, they are there to distract and divert you from following your true path home. Because once you have made it back, you can never be anyone's slave.

CHARTER - SUPPLEMENTAL POST 12

Truth will not leave you in peace, until you have the courage to face and accept it.

APPENDIX E - GANDALF AND FRODO'S EXCHANGE IN KHAZAD-DÛM

Dialogue from the movie, *"The Lord of the Rings, The Fellowship of the Ring"* Special Extended DVD Edition, Disk 2. Time: 20:32 - 22:54.

Some wise words to consider and keep in mind.

TRANSCRIPT

Frodo There's something down there.

Gandalf It's Gollum.

Frodo Gollum?

Gandalf He's been following us for three days.

Frodo He escaped the dungeons of Barad-dûr.

Gandalf Escaped, or was set loose? And now the ring has drawn him near.

He won't never be rid of his need for it.

He hates and loves the ring, as he hates and loves himself.

Sméagol's life is a sad story.

Yes, Sméagol he was once called, before the ring found him.

Before it drove him mad.

A BEAUTIFUL ACHING

Frodo It's a pity Bilbo didn't kill him when he had the chance.

Gandalf Pity?

It was pity that stayed Bilbo's hand.

Many that live deserve death and some that die deserve life. Can you give it to them Frodo?

Do not be too eager to deal out death and judgement. Even the very wise cannot see all ends.

My heart tells me that Gollum has some part to play yet, for good or ill, before this is over.

The pity of Bilbo may rule the fate of men.

Frodo I wish the ring had never come to me.

I wish none of this had happened.

Gandalf So do all who live to see such times but that is not for them to decide. All we have to decide is what to do with the time that is given to us.

There are other forces at work in this world Frodo besides the will of evil.

Bilbo was meant to find the ring; in which case you also were meant to have it, and that is an encouraging thought.

Oh! It's that way.

APPENDIX F - FALLING IN REVERSE

Ronnie Radke and his band, Falling In Reverse, do a great job of conveying what the process of Awakening feels like in the following song examples.

Brilliant!

- The Drug In Me Is Reimagined
- Popular Monster
- Voices In My Head
- Watch The World Burn

THE DRUG IN ME IS REIMAGINED

LYRICS

I heard a knock upon my door the other day.
I opened it to find death staring in my face.
The feel of mortal stalking still reverberates.
Everywhere I go I drag this coffin, just in case.

My body's trembling, sends shivers down my spine.
Adrenaline kicks in, shifts into overdrive.
Your secrets keep you sick, your lies keep you alive.
Snake eyes every single time you roll with crooked dice.

I felt the darkness as it tried to pull me down.
The kind of dark that haunts a hundred-year-old house.
I wrestle with my thoughts; I shook the hand of doubt.
Running from my past, I'm prayin', "*Feet, don't fail me now.*"

I lost my god-damn mind; it happens all the time.
I can't believe I'm actually meant to be here.
Trying to consume, the drug in me is you.
And I'm so high on misery, can't you see?

I've got these questions always runnin' through my head.
So many things that I would like to understand.
If we are born to die and we all die to live.
Then what's the point of livin' life if it just contradicts?

I felt the darkness as it tried to pull me down.
The kind of dark that haunts a hundred-year-old house.
I wrestle with my thoughts; I shook the hand of doubt.
Running from my past, I'm prayin', "*Feet, don't fail me now.*"

I lost my god-damn mind; it happens all the time.
I can't believe I'm actually meant to be here.

A BEAUTIFUL ACHING

Trying to consume, the drug in me is you.
And I'm so high on misery, can't you see?

I've lost myself.
You tried to reach me but you just can't help me.
So long, goodbye.
You tried to save me, it won't work this time, 'cause now,

I've lost my fuckin' mind and there's no fuckin' time.
I can't believe I'm actually meant to be here.
Trying to consume, the drug in me is you.
And I'm so high on misery, can't you see?

Can't you see?
Can't you see?

Can't you..., can't you...

Can't you see?

Can't you see?

POPULAR MONSTER LYRICS

Yeah.

I wake up every morning with my head up in a daze.
I'm not sure if I should say this, fuck, I'll say it anyway.
Everybody tries to tell me that I'm goin' through a phase.
I don't know if it's a phase, I just wanna feel okay, yeah.

I battle with depression, but the question still remains.
Is this post-traumatic stressin' or am I suppressin' rage?
And my doctor tries to tell me that I'm going through a phase.
Yeah, it's not a fuckin' phase, I just wanna feel okay.

Okay, yeah, I struggle with this bullshit every day.
And it's probably 'cause my demons simultaneously rage.
It Obliterates Me, Disintegrates Me, Annihilates Me.

I'm about to break down.
I'm searchin' for a way out.
I'm a liar, I'm a cheater, I'm a non-believer.
I'm a popular, popular monster.

I break down.
Falling into love now with falling apart.
I'm a popular, popular monster.

I think I'm going nowhere like a rat trapped in a maze.
Every wall that I knock down is just a wall that I'll replace.
I'm in a race against myself, I try to keep a steady pace.
How the fuck will I escape if I never close my case?

Oh my God, I keep on stressin', every second that I waste.
Is another second sooner to a blessing I won't take.
But my therapist will tell me that I'm going through a stage.
Yeah, it's not a fucking stage, I just wanna feel okay.

Okay, mother-fucker, now you got my attention.
I need to change a couple things 'cause somethin' is missing.
And what if I were to lie? Tell you everything is fine.
Every single fucking day I get closer to the grave.

I am terrified, I fell asleep at the wheel again.
Crashed my car just to feel again.
It Obliterates Me, Disintegrates Me, Annihilate Me.

'Cause I'm about to break down.
I'm searchin' for a way out.
I'm a liar, I'm a cheater, I'm a non-believer.
I'm a popular, popular monster.

I break down.
Falling into love now with falling apart.
I'm a popular, popular fucking monster, yeah.

Yeah, here we go again, mother-fucker, oh!

We're sick and tired of wondering.
Praying to a god that you don't believe.
You're searching for the truth in the lost and found.
So the question I ask is, "*Yeah, where the fuck is your god now?*"

'Cause I'm about to break down.
I'm searchin' for a way out.
I'm a liar, I'm a cheater, I'm a non-believer.
I'm a popular, popular monster.

I break down.
Falling into love now with falling apart.
I'm a popular, popular monster.

I'm a liar, I'm a cheater, I'm a non-believer.
I'm a popular, popular monster.

VOICES IN MY HEAD LYRICS

The voices in my head keep on tellin' me to pray.
'Cause I'm spinning like a carousel, circling the drain.
Hit the bottom of the bottle, I don't wanna feel the pain.
But that is all I got for now, I don't wanna talk about...

The voices in my head keep on begging me to stay.
If I pull the trigger now then the demons go away.
And I know my time is coming so there ain't no time to waste.
So that is all I got for now, I don't wanna talk about it.

The voices in my head keep tellin' me to choose a side.
It's heaven or hell like it's do or die.
I'm a sad boy, you know better.
Please don't make this last forever.

The voices in my head keep tellin' me I'm not okay.
It's feeling like a hurricane in my brain.
Dark Clouds, Hard Times, Bad Weather.
Please don't make this last forever.

Eye E Eye E Eye E Eye

The voices in my head keep on tellin' me I'm gonna *Die*.
And I don't wanna talk about the drama, I'm trauma-*tized*.
They're tellin' me I'm fine but we both know that's a fuckin' *Lie*.
I'm losing my mind, but I don't wanna talk about it.

The voices in my head keep givin' me the worst advice.
Kamikaze crash, like a suicide.
I'm a lost boy, you know better.
Please don't make this last forever.

The voices in my head keep tellin' me that I'm insane.
And maybe I'm a little bit, that won't change.

Dark Clouds, Hard Times, Bad Weather.
Please don't make this last forever.

Eye E Eye E Eye E Eye

The voices in my head keep on tellin' me I'm gonna *Die*.
And I don't wanna talk about the drama, I'm trauma-*tized*.
They're tellin' me I'm fine but we both know that's a fuckin' *Lie*.
I'm losing my mind, but I don't wanna talk about...

The voices in my head keep on tellin' me I'm cursed.
I'm paranoid, I don't wanna make it any worse.
We're all gonna die but first things first.
I'ma take the world with me when they put me in the dirt.

The voices in my head keep on tellin' me I'm cursed.
I'm paranoid, I don't wanna make it any worse.
We're all gonna die but first things first.
I'ma take the world with me when they put me in the dirt.

Move!

Move

The voices in my head are tellin' me I'm cursed.
I'm paranoid, I don't wanna make it any worse.
We're all gonna die but first things first.
I'ma take the world with me when they put me in the...

Eye E Eye E Eye E Eye

The voices in my head keep on tellin' me I'm gonna *Die*.
And I don't wanna talk about the drama, I'm trauma-*tized*.
They're tellin' me I'm fine but we both know that's a fuckin' *Lie*.
I'm losin' my mind but I don't wanna talk about...

Eye E Eye E Eye E Eye

The voices in my head keep on tellin' me to pray.
'Cause I'm spinning like a carousel, circling the drain.

Die E Eye E Eye E Eye

Hit the bottom of the bottle, I don't wanna feel the pain.
I'm losing my mind, but I don't wanna talk about it.

WATCH THE WORLD BURN

LYRICS

Yeah, I got voices in my head again, tread carefully.
And I don't medicate, it helps me temporarily.
I got problems, I got issues, yeah, apparently.
Trauma that I'm burying, I think I need some therapy.

I battle depression, I'm back with a message.
I'm asking the question that if you hate me, why you acting obsessive?
I'm past the point of no return, fuck being passive aggressive.
I'll brandish a weapon, teach all you mother-fuckers a lesson, yeah.

I actually battle my demons and shadows.
They swim in the deep and they creep in the shallows.
I'm lost.
Gotta admit that I'm living the life that I've always wanted.
But it comes at a cost.

Yeah, they're licking their chops.
They're fixing to rip me a part.
I'm swimming with sharks.

I'm lifting the bar.
I'm lifting it into the stars.
I'm like a shot of adrenaline,
mixed with some Ritalin.

You started a battle, but bitch I'ma finish it.
You think you can stop me, not even a little bit.
Nowadays everybody's so sensitive.

Taking my words and you pick it a part.
Tripping on nothing just get in the car.
Gripping and ripping I'm sticking the mark.
I'm tipping the ch-ch-ch-ch-ch-ch-charts.

I got enemies trying to get rid of me.
Evil tendencies are fucking with me mentally.
I got people that don't like me in the industry.
I can feel your energy, you are not a friend to me.

'Cause I have been to places that you never wanna go, yeah.
I got dirt on people, but they act like I don't know, yeah.
I could do some damage, but I'll never rock the boat.
All it takes is one post, watch 'em fall like dominoes.

You'll never get rid of me,
too many mini-me's ripping my imagery.
You know my history, it ain't a mystery.
I put every enemy outta they misery.

Somebody send me some positive energy.
About to go Darth, about to go Disney.
Into the darkness, into Infinity
and shut you mother-fuckers up, you listening?

Stacking every little pretty penny that I'm getting
and I'm never giving into anybody, always winning.
Never kidding when I die, I'm taking everybody with me.
You're never gonna get me, 'cause you'll never see it simply.

I'm a mother-fucking god!

You're a light yawn.
I'm a time bomb and the vibes wrong,
is this mic on?

I'm killing the syllables with a loaded refillable.

I'm a lyrical typical super villain, I'm venomous.
And I'm never gonna stop until they put me on top of the list.

I can't control the monster any longer that's inside.

The pain and sorrow left us hollow.
No tomorrows, hard to swallow.
Death is calling, so appalling.
Tightrope walking, now I'm falling down.

Like missiles falling from the sky.
Come and save us.
The pain and sorrow left us hollow.
Here today but gone tomorrow.

The pain inside is the fuel that drives
this flesh and bone through blood red skies.
Ha Ha Ha Ha Ha Ha Ha Ha.
The death defying, hypnotising.

One day you're gonna figure out that,
everything they taught you was a lie.

Watch The World Burn!

Rah!

Ooh!

The fear, keeps you alive.
Break the fucking chains, take back your life.
The fear is what keeps you insane.
Break the fucking chains, take away the pain.

APPENDIX G - THE MIDDLE EAST SOLUTION, LIVE!

THREE WAY! NO RULES! CAGE MATCH!

HAMAS TERRORISTS

The Leadership of the Hamas
Terrorist Organisation.

vs

ISRAELI PSYCHOPATHS

The Insane Psychopaths
of the Israeli Government and Defence Force.

vs

WESTERN VERMIN

A Broad Collection of British and
American Deep State and Political Shit Bags.

Since these are the Originators of this Conflict.

A world first, Three Way! No Rules! Cage Match!, between three equally reprehensible groups, to decide once and for all, the ruler of the piece of dirt in the Middle East known as Israel/Palestine.

A BEAUTIFUL ACHING

This special event has been organised so that no more innocent people, young or old, are obliterated by cowards hiding in comfortable homes and offices, far away from any real danger themselves.

Upon entering the ring, these three foes will decide how this event is to proceed.

They can either choose to tear each other apart like the rabid monsters they are, or they can decide to resolved their differences in a civilised manner.

The cage will not be re-opened again, until all the participants have either destroyed themselves or have come to a peaceful, permanent resolution to this conflict.

The choice is theirs.

This historic clash is to be broadcast on pay-per-view across the entire world. With proceeds going to the families of innocent Israelis killed by Hamas Terrorists and innocent Palestinians whose lives have been destroyed by Israeli Psychopaths.

Additionally, regardless of the outcome, all participants's personal assets are to be seized and will contribute to the Innocent Israeli/Palestinian Fund.

SPECIAL VICTORY CONDITION

If the entire Western Vermin team is annihilated by the other two contenders and the other two contenders manage to reach a peaceful, permanent solution between themselves, the cage will then be re-opened and remaining members of these two groups are given the opportunity to live out the rest of their lives, without their personal assets.

Stay tuned, for further details.

Also Coming Soon!

BRUSSELS GARDENERS

vs

MOSCOW BEARS

This time it's personal.

CONTEXT FOR THE BRUSSELS GARDENERS NAME

THE EUROPEAN GARDEN

“Europe is a garden. We have built a garden. Everything works. It is the best combination of political freedom, economic prosperity and social cohesion that the humankind has been able to build – the three things together. And here, Bruges is maybe a good representation of beautiful things, intellectual life, well-being.

The rest of the world – and you know this very well, Federica – is not exactly a garden. Most of the rest of the world is a jungle, and the jungle could invade the garden. The gardeners should take care of it, but they will not protect the garden by building walls. A nice small garden surrounded by high walls in order to prevent the jungle from coming in is not going to be a solution. Because the jungle has a strong growth capacity, and the wall will never be high enough in order to protect the garden.

The gardeners have to go to the jungle. Europeans have to be much more engaged with the rest of the world. Otherwise, the rest of the world will invade us, by different ways and means.

A BEAUTIFUL ACHING

Yes, this is my most important message: we have to be much more engaged with the rest of the world.”

Josep Borrell.

Vice-President of the European Commission.

High Representative of the European Union for Foreign Affairs and Security Policy.



A BEAUTIFUL ACHING

APPENDIX H - THE UNITED STATES CONSTITUTION

If the United States Constitution is such a great document, why is it not the basis by which the United States treats everyone else around the world?

Why is the spirit of the United States Constitution not the basis for United States Foreign Policy?

Why is there a discrepancy between United States Government behaviour within United States borders and external to United States borders?

Are only Americans worthy of being treated with Respect and Dignity by the United States Government?

Maybe this is why the United States Government is beginning to treat Americans the same way it treats everyone else around the world.

Maybe the inconsistency was just not sustainable.

*Liberty at Home, Tyranny Abroad,
eventually becomes,
Tyranny Everywhere.*

A BEAUTIFUL ACHING



A BEAUTIFUL ACHING

APPENDIX I - RIDING ON COATTAILS

To all those that enjoy patting themselves on the back for being American and consider America the *“greatest country in the world”*, are your self-congratulatory back slaps really justified?

Those that fought for the independence of the United States of America, especially the Founding Fathers, truly were exceptional Individuals.

However, every generation since has not improved on that vision, instead they have allowed the gradual degradation of the United States into an imperialist tyranny, within and without its borders.

Is this worthy of praise? Is this worthy of the title, *“The Greatest”*?

Or is it more rightly a source of shame?

To be given so much, only to squander it all.

The Beacon of Liberty that the United States was for Humanity, is dying.

How many are there, of the quality of the Founding Generation, to ensure that this does not happen?

How many are there, that are willing to make a real stand, not simply pat themselves on the back for the past achievements of others?

There are many on the outside looking in, doing whatever possible to ensure that the founding vision of the United States does not fall.

For it is not only the people of the United States at stake, it is all of Humanity.

A BEAUTIFUL ACHING



A BEAUTIFUL ACHING

